

Tables of composition and nutritional value of feed materials

editors D. Sauvant, J.-M. Perez and G. Tran



pigs
poultry
cattle
sheep
goats
rabbits
horses
fish

Tables of composition and nutritional value of feed materials

This book is a translation of the French original work "*Tables de composition et de valeur nutritive des matières premières destinées aux animaux d'élevage*".

© INRA, 2002, ISBN 2-7380-1046-6

2nd revised and corrected edition © INRA 2004, ISBN 2-7380-1158-6

This translation includes 4 additional products:

- Blood meal,
- Feather meal,
- Meat and bone meal, fat < 7.5%,
- Meat and bone meal, fat > 7.5%.

At the time of writing, the sale and use of these products are prohibited in the European Union and in other countries.

The data for amino acid digestibility in the pig are taken from: AFZ, Ajinomoto Eurolysine, Aventis Animal Nutrition, INRA, ITCF, 2000. *AmiPig. Standardised Ileal Digestibility of amino acids in feedstuffs for pigs*, AFZ, Paris. (Document available at: www.feedbase.com/amipig)

The relative biological values of mineral sources are taken from: EMFEMA, 2002, *Bioavailability of major and trace minerals*, EMFEMA, Bruxelles. (Document available at: www.emfema.org)

The data are reproduced with the permission of the copyright holders.

For additional information, visit the website of the INRA-AFZ tables:
www.inapg.fr/dsa/afz/tables

Tables of composition and nutritional value of feed materials

Pigs, poultry, cattle, sheep, goats, rabbits, horses and fish

Scientific editors:

Daniel Sauvant, Jean-Marc Perez and Gilles Tran

Translated by:

Andrew Ponter

This book is the collective work of researchers and lecturers from

- the Institut National de la Recherche Agronomique (INRA),
- the Association Française de Zootechnie (AFZ) and
- the Institut National Agronomique Paris-Grignon



Wageningen Academic
P u b l i s h e r s

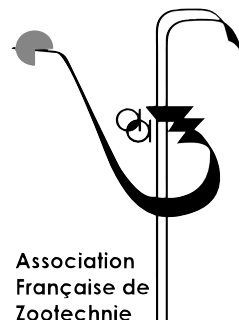

**CIP-data Koninklijke Bibliotheek
Den Haag**

**ISBN: 978-90-76998-41-1
e-ISBN: 978-90-8686-668-7
DOI: 10.3920/978-90-8686-668-7**

**Subject headings:
Rearing
Nutrition**

First published, 2004

**Cover illustrations:
Corel Professional Photos,
Emmanuelle Bourgeat, Gilles Tran**

**© Wageningen Academic Publishers
The Netherlands
&
INRA, Paris
France**

2004

Printed in The Netherlands

All rights reserved.

Nothing from this publication may be reproduced, stored in a computerised system or published in any form or in any manner, including electronic, mechanical, reprographic or photographic, without prior written permission from either publisher: Wageningen Academic Publishers, P.O. Box 220, NL-6700 AE Wageningen, The Netherlands or Institut National de la Recherche Agronomique, INRA Editions, RD 10, 78026 Versailles cedex, France

The individual contributions in this publication and any liabilities arising from them remain the responsibility of the authors.

In so far as photocopies from this publication are permitted by the Copyright Act 1912, Article 16B and Royal Netherlands Decree of 20 June 1974 (Staatsblad 351) as amended in Royal Netherlands Decree of 23 August 1985 (Staatsblad 471) and by Copyright Act 1912, Article 17, the legally defined copyright fee for any copies should be transferred to the Stichting Reprorecht (P.O. Box 882, NL-1180 AW Amstelveen, The Netherlands).

For reproduction of parts of this publication in compilations such as anthologies or readers (Copyright Act 1912, Article 16), written permission must be obtained from the publisher.

The authors

Valérie Bontems

INRA-AFZ

Data collection and processing

16, rue Claude Bernard, 75231 Paris Cedex 05,
France

Patrick Chapoutot

UMR INRA-INA P-G

Physiologie de la nutrition et alimentation

16, rue Claude Bernard, 75231 Paris Cedex 05,
France

Brigitte Doreau[†]

INRA

Unité de recherche sur les herbivores

63122 Saint-Genès-Champanelle, France

Catherine Jondreville

UMR INRA-ENSAR

Veau et porc

35590 Saint-Gilles, France

Sadasivam J. Kaushik

INRA

Unité de recherches en hydrobiologie

64310 Saint-Pée-sur-Nivelle, France

Michel Lessire

INRA, Station de recherches avicoles

37380 Nouzilly, France

William Martin-Rosset

INRA

Unité de recherche sur les herbivores

63122 Saint-Genès-Champanelle, France

François Meschy

UMR INRA-INA P-G

Physiologie de la nutrition et alimentation

16, rue Claude Bernard, 75231 Paris Cedex 05,
France

Jean Noblet

UMR INRA-ENSAR

Veau et porc

35590 Saint-Gilles, France

Jean-Marc Perez

INRA

Station de Recherches Cunicoles

Chemin de Borde-Rouge, Auzeville, BP 27

31326 Castanet-Tolosan Cedex, France

Jean-Louis Peyraud

UMR INRA-ENSAR

Production du lait

35590 Saint-Gilles, France

Henri Rulquin

UMR INRA-ENSAR

Production du lait

35590 Saint-Gilles, France

Daniel Sauvant

UMR INRA-INA P-G

Physiologie de la Nutrition et Alimentation

16, rue Claude Bernard, 75231 Paris Cedex 05,
France

Bernard Sève

UMR INRA-ENSAR

Veau et porc

35590 Saint-Gilles, France

Gilles Tran

Association Française de Zootechnie

French Feed Database

16, rue Claude Bernard, 75231 Paris Cedex 05,
France

This text was translated by *Andrew Ponter* (Ecole Nationale Vétérinaire d'Alfort, France) with additional revisions by Gilles Tran and the original authors.

Acknowledgements

The authors would particularly like to thank Jacques Robelin, head of the Department of Animal Breeding and Nutrition of the Institut National de la Recherche Agronomique (National Institute for Agricultural Research, INRA) from 1994 to 2002, for financial support and constant encouragement during the creation of these tables.

The authors are indebted to the researchers of INRA and other organisms who contributed to this book by their work or advice. It is impossible to name all the people involved, but we would like to mention:

Daniel Bourdon	Yves Henry [†]
Bernard Carré	Olivier Lapierre
Julien Coléou [†]	François Lebas
Jacques Delage	Bernard Leclercq
Camille Demarquilly	Luc Maertens (CLO-DVV-Gent, Belgium)
Claude Février	Pierre Morand-Fehr
Sylvie Giger-Reverdin	Yves Nys
Ian Givens (University of Reading, United Kingdom)	Michel Vermorel
Léon Gueguen	

The Association Française de Zootechnie (AFZ, French Association for Animal Production) manages the French Feed Database since 1989. The Database was created with the help of the French Ministry of Agriculture, INRA and the companies and organisations listed below. The authors gratefully thank these organisations for their continuing support over the past fifteen years, making it possible to publish these tables.

Ajinomoto Animal Nutrition	Cooperl-Hunaudaye	MG2MIX
Arvalis	Désialis	ONIDOL
Centralys	Glon-Sanders	Techna
CCPA	INZO ^o	UNICOPA
CIRAD	ITP	UNIP
CETIOM	Lesaffre International	USICA

We also thank:

The EMFEMA (International Association of the European Manufacturers of Major, Trace and Specific Feed Mineral Materials), which accepted that the results from their study on the biological value of mineral sources be included in the tables.

Adisseo (formerly Aventis Nutrition Animale), for its participation in the AmiPig programme.

The GERNA (Groupement pour l'encouragement à la recherche en nutrition animale), which made a significant contribution to some of the work presented in the tables.

Ajinomoto Animal Nutrition for its financial support in the adaptation and translation of the INRA-AFZ tables into English.

Table of contents

The authors	5
Acknowledgements	7
Foreword	11
Construction of the tables	13
Chemical data and nutritional value	17
Nutritional values for pigs	25
Nutritional values for poultry	37
Nutritional values for ruminants	43
Nutritional values for rabbits	53
Nutritional values for horses	57
Nutritional values for fish	67
Biological values of mineral sources	71
Abbreviations	73
Tables of composition and nutritional value	77
Cereals	78
Wheat by-products	98
Maize by-products	118
Other cereal by-products	134
Legume and oil seeds	144
Oil seed meals	170
Starch, roots and tubers	202
Other plant by-products	212
Dehydrated forages	252
Dairy products	264
Fish meals and solubles	272
Other animal by-products	282
Processed feed materials: nutritional values for ruminants	290
Fats	294
Synthetic amino acids	297
Relative biological values of mineral sources	298
Index	303

Foreword

Daniel Sauvart, Gilles Tran, Jean-Marc Perez and Jacques Robelin

Since the origins of domestication, the feeding of farm animals has benefited from the rationalisation and improvement of agricultural techniques and practices at a quasi-exponential rate. At the end of the 18th century, the discovery of energy and of the elements of matter, soon followed by studies on the analytical characterisation of animal feeds, led to the formulation of the first tables of chemical composition and nutritional value. Since then, feed tables have been revised and improved regularly. In France, the pioneers of animal feeding were notably André-Max Leroy of INA-PG, initiator of animal science research at INRA and founder of the French Association of Animal Production (AFZ), and René Jarrige, whose career as a director of research at INRA was focused on the nutrition and feeding of herbivores. The French tables are a continuation of their work.

INRA has published three reference books: *L'alimentation des animaux monogastriques* (1984), *Alimentation des bovins, ovins et caprins* (1988) and *L'alimentation des chevaux* (1990). These books, and particularly their feed tables, have been very successful. However, these data were clearly in need of updating: this is the objective of the present book, which integrates the evolution in feed materials and new nutritional concepts. These tables are the first multi-species tables available in French and are the result of a fruitful collaboration between INRA and AFZ, the manager of the French Feed Database.

In this book, the data concerning chemical composition, which were collated and summarised by AFZ, are identical for all species. The data for nutritional values were mainly derived from *in vivo* measurements performed in seven INRA laboratories. These data were then corrected to make them consistent with the chemical composition of the feed materials. An innovative feature of this work is the traceability of the methods used to calculate the published values.

Animal feeding is experiencing tremendous changes. Its initial objective - to meet nutritional requirements - is now only one of many challenges: we must understand and control its impact on product quality and safety, on animal welfare and health, and on the environment. These wider objectives require the development of new concepts of nutritional value of feedstuffs, for which these tables are a useful basis. The new feed characteristics provided therein (amino acid digestibility, availability or digestibility of minerals, cation-anion difference) are definitely within this framework.

We are certain that the people involved in animal feeding - researchers, advisors, lecturers, extension officers, feed manufacturers, veterinarians and farmers - will greatly benefit from the information contained in this book.

Construction of the tables

Daniel Sauvant and Gilles Tran

Feed materials

The feed materials described in the tables are, in most cases, the ones used in industrial compound feeds. They were chosen according to their frequency of use, estimated from the French Feed Database. We added less common feed materials when reliable nutritional data were available for them.

Some readers may be surprised by the absence of forages in a book containing ruminant, horse and rabbit data. In fact, INRA has undertaken an in-depth review of the concepts and the values for forages, particularly for ruminants, and this work was not yet finished at the time of writing. When the review has been completed, a new edition of this book or specific tables will be published for forages.

Concerning the choice of feed names and categories (e.g. the different types of oil seed meals), we have tried to make sure that each category is representative of actual feed materials and sufficiently individualised from a nutritional point of view. For instance, the barley data refer to a generic barley grain, irrespective of the type (2-row or 6-row): while these two species have a slightly different composition, they are rarely identified as such in the feed market. Another example is soybean meal, for which there are many different categories available commercially. These categories, often defined by their protein or protein + fat value, are marketed separately and can have specific nutritional properties. They can also change over time or even disappear. Therefore, we grouped these categories into three main soybean meal types that are both representative and nutritionally distinct.

However, the reader should keep in mind that table values, however well designed, are only indicative.

Chemical data

Origin

The chemical composition values have been collected by AFZ using its own database of feed information. Started in 1989, this database contains more than one million values of chemical, physical and nutritional characteristics of feed materials, most of them obtained from the participating laboratories (the list of companies and organisations is presented in the Acknowledgements section p. 7).

As often as possible, the chemical compositions were established from original and recent data that were accessible in sufficient numbers to allow critical evaluation. When more than 500 values were available, the averages were calculated for the samples collected (cereal grains, legume and oil seeds, French oil seed meals) or marketed starting from 1995. In addition, the

data in the top or bottom 5% were removed from the calculations. A standard deviation was calculated when 5 or more values were available.

Literature values were used in the absence of original data, or in order to complete a data set. This was notably the case for vitamins and for part of the trace elements and fatty acids data.

A list of the tables used in order to produce this book is given in the reference list at the end of this chapter. Due to lack of space, not all the references used are cited.

Consistency of composition vectors

For the same feed material, the number of available values can be very different for certain characteristics compared to others. For example, the crude protein content of soft wheat was calculated using more than 7000 original values while the number of results available for tryptophan was only 65. Also, there were 8 times more crude fibre values than ADF values available in our database. This may cause consistency issues when mean values are calculated using different numbers of original data per characteristic. In order to obtain coherent composition vectors, we have calculated regression equations using common characteristics (such as crude fibre) to predict less frequent ones (such as ADF). These equations are specific for a feed material or for a group of feed materials. We have also used equations from the scientific literature. A total of more than 2000 regression equations were established, of which more than half were used to perform adjustments. The crude protein content was usually the “pivot value” from which other values could be predicted in a cascade, depending on the availability of significant equations.

Nutritional value data

Basis

The starting point was to respect scrupulously the concepts of the evaluation systems used for different species. The nutritional values were calculated so that they were consistent with the values of chemical composition for a particular feed material. Although the calculations are described for each species in their respective chapters, the general method is common to all species. Firstly, individual data of nutritional value obtained *in vivo* were collected from INRA or from the literature. Secondly, relationships were identified between the nutritional values and the chemical composition of the samples. These relationships are applicable for well-defined families of feed materials or for larger groups of feed materials (for example, grains or seeds and their by-products). The choice of which feed materials were to be grouped together was systematically based on statistical analyses. We also used equations from other sources when they were considered reliable.

When relationships could be determined, components of nutritional value, such as the *in vivo* digestibility of the organic matter, were calculated by regression so that they corresponded with the average values of chemical characteristics given in the table. Many of these equations use cell wall constituents (crude fibre, NDF, ADF or ADL) as predictors, but other parameters were

taken into account depending on the species, the feed materials and the characteristics to be predicted.

When pertinent equations were not available, the traditional approach based on average values was used. We then checked the consistency between the samples used in the corresponding trials and the chemical composition presented in the tables. Finally, in some rare cases, the data were taken from previous tables because no well-documented original data were available.

New or recent nutritional characteristics

Several new or recent nutritional characteristics of feed materials are introduced in these tables.

In the case of pigs, net energy content (growing pigs and sows), phosphorus availability and amino acid digestibilities of feed materials have been added. Amino acid digestibilities were derived (with modifications) from the AmiPig tables published in 2000 by different partners, amongst them INRA and AFZ. In the case of rabbits, the tables used the digestibility data (also with some modifications) and the concept of metabolisable energy published by Perez et al. (1998). The fish values were derived from the same sources used to establish the tables in *Nutrition et Alimentation des poissons et crustacés* (Guillaume et al., 1999).

In the case of ruminants, the tables now include the digestible amino acids in the intestine, calculated according to the method published by Rulquin et al. (1993 and 2001). In addition to updating the *in sacco* degradability values for nitrogen in the rumen and the intestine, we have indicated the kinetic parameters of *in sacco* degradation of dry matter and starch in the rumen. We have also included, when the data were available, the levels of absorbed phosphorus for ruminants.

Finally, for mineral sources, the tables present the summary of a literature study performed for the EMFEMA concerning the relative biological value of minerals and trace elements for pigs, poultry and ruminants.

References

- AFZ, Ajinomoto Eurolysine, Aventis Animal Nutrition, INRA, ITCF, 2000. *AmiPig, Digestibilités iléales standardisées des acides aminés des matières premières chez le porc.*, AFZ, Paris.
- Becker M., Nehring K., 1965. *Handbuch der Futtermittel*. Ed. Verlag Paul Parey, Berlin.
- CVB, 2000. *Veevoedertabel 2000. Chemische samenstelling, verteerbaarheid en voederwaarde van voedermiddelen*. Centraal Veevoederbureau, Lelystad, The Netherlands.
- Degussa, 1995. *The amino acid composition of feedstuffs*. Degussa AG, Frankfurt am Main.
- DLG, 1991. *DLG-Futterwertabellen für Wiederkäuer*. DLG-Verlag, Frankfurt am Main.
- Favier, J.-C., Ireland-Ripert, J., Toque, C., Feinberg, M., 1995. *Répertoire général des aliments, Table de composition*. Lavoisier Technique & Documentation, INRA Editions, Paris.
- Feinberg M., Favier J.-C., Ireland-Ripert J., 1987. *Répertoire général des aliments :T.1. Table de composition des corps gras*. Lavoisier Technique & Documentation, INRA Editions, Paris.
- Feinberg M., Favier J.-C., Ireland-Ripert J., 1987. *Répertoire général des aliments :T.2. Table de composition des produits laitiers*. Lavoisier Technique & Documentation, INRA Editions, Paris.

- FEDNA, 1999. *Normas FEDNA para la formulación de piensos compuestos*. FEDNA, Madrid, 496 p.
- Givens D. I., Cottrill B. R., Davies M., Lee, P. A., Mansbridge R. J., Moss A. R., 2000. Sources of n-3 polyunsaturated fatty acids additional to fish oil for livestock diets - a review. *Nutr. Abstr. Rev. Series B: Livestock Feeds and Feeding*, 70, 1-19.
- Guillaume J., Kaushik S., Bergot P., Métailler R., 1999. *Nutrition et alimentation des poissons et crustacés*. INRA Editions - IFREMER, Paris, 489 p.
- INRA, 1988. *Alimentation des bovins, ovins et caprins*. INRA Editions, Paris, 471 p.
- INRA, 1989. *L'alimentation des animaux monogastriques : porc, lapin, volailles*. INRA Editions, Paris, 282 p.
- INRA, 1990. *L'alimentation des chevaux*. W. Martin-Rosset Ed. INRA Editions, Paris, 232 p.
- Lamand M, Tressol J.-C., Ireland-Ripert J., Favier J.-C., Feinberg M., 1996. *Répertoire général des aliments : T.4. Table de composition minérale*. Lavoisier Technique & Documentation, INRA Editions, Paris.
- Morand-Fehr P., Tran G., 2001. La fraction lipidique des aliments et les corps gras utilisés en alimentation animale. *Prod. Anim.*, 14, 285-302.
- National Academy of Sciences, 1972. *Atlas of nutritional data on United States and Canadian feeds*. National Academy of Sciences, Washington DC.
- National Committee on Danish Cattle Husbandry, 1995. *Composition and feed value of cattle feeds*. Foulum, Denmark.
- Novus International, 1996. *Raw material compendium*, 2nd Edition. Novus Europe, Bruxelles.
- NRC, 1977. *Nutrient requirements of rabbits* (2nd Ed.). Nat. Acad. Sci., Washington, DC, USA, 30 p.
- NRC, 1984. *Nutrient requirements of poultry*: 8th Revised Edition. National Academy Press, Washington DC.
- NRC, 1988. *Nutrient requirements of dairy cattle*: 6th Revised Edition, Update 1988. National Academy Press, Washington DC.
- NRC, 1989. *Nutrient requirements of horses*. 5th Revised Edition. National Academy Press, Washington DC.
- NRC, 1993. *Nutrient requirements of fish*. National Academy Press, Washington DC.
- NRC, 1998. *Nutrient requirements of swine*. National Academy Press, Washington DC.
- NRC, 2001. *Nutrient requirements of dairy cattle*: 7th Revised Edition. National Academy Press, Washington DC.
- Perez J. M., Maertens L., Villamide M. J., De Blas C., 1998. Tables de composition et de valeur nutritive des aliments destinés au lapin : conclusions d'un groupe de travail européen. 7^{èmes} Journ. Rech. Cunicole Fr., Lyon, 13-14 mai 1998, 141-146. ITAVI Ed., Paris.
- Rulquin H., Guinard G., Pisulewski P., Vérité R., 1993. *Le système en lysine et méthionine digestible*. CAAA - AFTAA, le Mans, 22-23 juin 1993.
- Rulquin H., Vérité R., Guinard-Flament J., 2001. Acides aminés digestibles dans l'intestin. Le système AADI et les recommandations d'apport pour la vache laitière. *Prod. Anim.*, 14, 265-274.
- Scherz H., Senser F., 1994. *Food composition and nutrition tables*. Medpharm Scientific Publishers, Stuttgart; CRC Press, Boca Raton.
- Schiemann R., Nehring K., Hoffman L., Jentsch W., Chudy A., 1971. *Energetische Futterbewertung und Energienormen*. VEB Deutscher Landwirtschaftsverlag, Berlin, 344 p.
- Standing Committee on Animal Nutrition, 1990. *UK Tables of nutritive value and chemical composition of feedingstuffs*. Ministry of Agriculture, Fisheries and Food, London.
- USDA, 2002. *USDA Nutrient database for Standard Reference, Release 14*. USDA Agricultural Research Service, Nutrient Data Laboratory, Beltsville, Maryland.

Chemical data and nutritional value

Gilles Tran and Daniel Sauvant

Chemical data

Methods of analysis

The chemical characteristics published in the tables come mainly from data obtained on samples of feed materials analysed in the laboratories of feed companies. These measurements reflect the different types of feed materials marketed in France and Western Europe. The values were obtained using classical methods. These methods include those recommended by the standards organisations (ISO and AFNOR) and by other institutions (European Commission and AOAC), methods similar to or derived from standard ones, and methods recommended by certain authors (such as those initiated by Van Soest). Due to the large variability in data sources - which also include literature data- as well as the thoroughness and duration of data collection, a given chemical characteristic could have been obtained by several methods. To correct for this, the original results were validated at the source. Data obtained through atypical methods were discarded.

The table below summarizes the principal methods used to measure the chemical characteristics published in the tables.

Characteristics	Methods
Moisture	Methods based on dessication, such as AFNOR NFV18-109 for usual feed materials.
Crude protein	Methods based on mineralization of nitrogen, such as the Kjeldahl method (i.e. AFNOR NF V18-100, 1977) or the Dumas method (AFNOR NF V18-120, 1997) for the more recent data. The crude protein content is obtained by multiplying total nitrogen by 6.25.
Crude fibre	“Weende” methods, based on acid hydrolysis followed by alkaline hydrolysis, such as AFNOR NFV03-40 (1993). Crude fibre is a default estimate of the cell wall content, which is actually 2 to 4 times higher. The crude fibre residue includes variable proportions of different cell wall constituents, such as lignin.
Crude fat	Methods based on the extraction of lipid substances by a solvent such as diethyl ether, hence the usual appellation of “ether extract”. In France, the reference method for most feed materials is AFNOR NFV18-117 (1997). The use of HCl hydrolysis before extraction is indicated for some products.
Ash	Methods based on incineration, such as AFNOR NFV18-101.

Characteristics	Methods
Insoluble HCl fraction	Residue after incineration and HCl treatment, e.g. AFNOR NFV18-102.
Cell wall components by Van Soest	<p>Methods derived from the sequential method described by Van Soest (AFNOR NFV18-122, 1997):</p> <ul style="list-style-type: none"> • NDF (Neutral Detergent Fiber): cell wall material obtained by the action of dodecyl sulfate in a neutral medium, sometimes including the use of enzymes (amylase and protease). • ADF (Acid Detergent Fiber), ligno-cellulose obtained by the action of cetyletrimethylammonium bromide (CTAB), in a medium acidified by H_2SO_4. This is performed on the NDF residue. • ADL (Acid Detergent Lignin), lignin estimated after destruction of true cellulose by H_2SO_4 72% in the ADF residue.
Water insoluble cell walls	Cell walls obtained by the AFNOR NF V18-111 method, including treatments with an alpha-amylase and a protease, followed by the removal of lipids.
Starch	Ewers polarimetric method, e.g. 3 rd EC directive 72/199 modified 27/11/1980. Starch data obtained by enzymatic methods were not considered in the tables. A value of zero is given for starch-free materials such as oil seed meals and sugar beet pulp.
Total sugars	Most of the total sugars presented in the tables have been obtained by the Luff-Schoorl method (ethanol extraction). However, due to the lack of sugar values, enzymatic methods have also been taken into consideration.
Fatty acids	Methods based on the use of chloroform/methanol, methylation and extraction of methyl esters followed by chromatography. The fatty acids to crude fat conversion coefficients result from a compilation of literature data.
Amino acids	Acid hydrolysis (HCl 6N) followed by chromatography. There are many methods with variants in duration (24-48 hours) and temperature (110-145°C). Methionine and cystine are obtained after performic acid oxidation and tryptophan after alkaline hydrolysis.
Minerals and trace elements	Spectroscopic methods adapted for each mineral, such as AFNOR NFV18-108 for calcium and AFNOR NFV18-106 for phosphorus. Some values (particularly iodine) were derived from previous feed and food composition tables.

Characteristics	Methods
Phytate phosphorus	Organic plant phosphorus bound in phytic acid. Phytate phosphorus is calculated as 28.2% of phytic acid. Different methods can be used to measure phytic acid (precipitation of an iron composite or HPLC).
Phytase activity	One unit of phytase activity corresponds to the liberation of one μmol per minute of inorganic phosphorus from a solution of sodium phytate, measured at a fixed temperature and pH.
Vitamins	The data for vitamins come mainly from tables. The analytical methods were rarely indicated in the sources. <ul style="list-style-type: none"> • Vitamin A: vitamin A activity expressed in international units (1 IU = 0.3 μg of retinol); • Vitamin D: vitamin D2 in plant products and D3 in animal products. Vitamin D activity is expressed in international units (1 IU = 0.025 μg of cholecalciferol); • Vitamin E: the vitamin activity of tocopherols and tocotrienols is expressed as alpha-tocopherol.
Real applied viscosity	Real applied viscosity (Carré et al., 1994) is measured by viscosimetry of an aqueous extract. While potential applied viscosity is obtained after extraction with 80% ethanol, this treatment is not used for real applied viscosity in order to keep the endogenous enzymes active. Real applied viscosity values are not additive. Viscosity is expressed as: <ul style="list-style-type: none"> • Relative viscosity (η_r): viscosity (extract) / viscosity (buffer) • Applied viscosity (AV): $\text{Log}(\eta_r) / [\text{concentration (g/ml) of the starting material in the final extract}]$.

Dietary cation-anion difference

The dietary cation-anion difference (DCAD) for ruminants and the electrolyte balance (EB) for monogastrics characterise the “acidifying” or “alkalising” potential of a feed material or diet. It is a simple calculation integrating the ions that have the greatest influence on the acid-base equilibrium: potassium and sodium are “alkalising”, and chlorine and sulphur are “acidifying”. Sulphur is not taken into account in the calculation of EB.

$$\begin{aligned} \text{DCAD} &= [\text{K}^+ + \text{Na}^+] - [\text{Cl}^- + \text{S}^{2-}] \\ &= 1000 \times (\text{K}/39 + \text{Na}/23 - \text{Cl}/35.5 - \text{S}/16) \end{aligned}$$

$$\begin{aligned} \text{EB} &= [\text{K}^+ + \text{Na}^+] - [\text{Cl}^-] \\ &= 1000 \times (\text{K}/39 + \text{Na}/23 - \text{Cl}/35.5) \end{aligned}$$

DCAD and EB are expressed in mEq/kg of dry matter.

Na, K, Cl and S are expressed in g/kg of dry matter.

The values published in the tables are only indicators, since they can vary to a large extent depending on the other chemical constituents of the feed material.

Relevance of chemical composition data

- Proximate analysis (dry matter, crude protein, crude fibre, ether extract and ash), starch and sugars (for products containing a high percentage of these constituents), calcium and phosphorus are the components the most frequently measured in the samples that we have had access to. Because these analyses were obtained by long-established methods in experienced laboratories, it can be assumed that these data are as accurate as possible. Also, these analyses were available in large numbers, so that outlying values were easier to detect and discard. The variability of the data has been well characterised and standard deviations are given in the tables.
- Amino acids, cell wall components (other than crude fibre) and secondary minerals are quite frequently measured, but less so than the previous parameters. There are many variations in the analytical methods used for these parameters. However, it was usually possible to establish equations (applicable within a group of feed materials) to predict the final values of amino acids and cell wall components.
- Trace element data are not very common, and they are poorly correlated with other characteristics. In addition, their variability can be linked to factors such as the type of soil, the technological process, etc. Consequently, the values given in the tables, which are in the majority of cases averages calculated from the scientific literature, should only be used as indicators.
- Fatty acids are affected in a similar way to trace elements. Moreover, fatty acid values are expressed in different units in the literature and this makes accurate comparisons difficult. Another notable problem is the lack of data for individual fatty acids in feed materials containing little fat. In this case, the table values are often derived from the corresponding oil product. The values are only indicators and are subject to large variations.
- The vitamin content of feed materials has received little attention in the literature, except for products also used for human food, such as cereal grains. The values presented in the tables were collected, for the most part, in previous food and feed tables and others were taken from more recent literature.

Nutritional data

Energy values

Basis

Animals use the gross energy (GE) contained in the organic matter (OM) of ingested feeds according to a general scheme identical for all species (figure 1).

The best system to express the feed energy content is net energy (NE). In order to calculate NE, it is necessary to start with the GE value and predict sequentially the values of energy digestibility as well as the energy lost in the form of methane, urine and heat increment.

Gross energy

Gross energy is measured by calorimetry. It can also be predicted from the chemical composition using a coefficient for each constituent and different models can be used. For the tables, we have tried to base the prediction equations on the common and readily available measurements of the proximate analysis. A statistical analysis performed on more than 2000 gross energy values resulted in the following equation:

$$GE = 17.3 + 0.0617 CP + 0.2193 EE + 0.0387 CF - 0.1867 Ash + \Delta$$

GE is gross energy expressed in MJ/kg of dry matter; CP, EE, CF and Ash represent crude protein, ether extract, crude fibre and minerals respectively, expressed in % dry matter.

Δ : correction coefficient (positive or negative) to be used according to the type of feed material. Several statistical analyses were conducted in order to optimise the determination of Δ (Tran and Sauvant, unpublished). The following table presents the specific Δ values for different groups of feed materials.

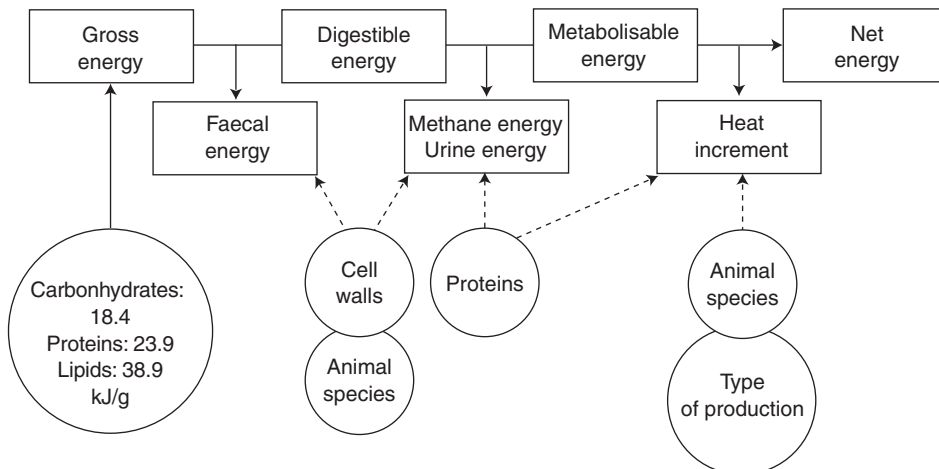

Figure 1. The different steps in feed energy utilisation.

Feed material group	Δ
Corn gluten meal	1.29
Blood meal	1.12
Alfalfa protein concentrate	1.04
Wheat distillery by-product, wheat gluten feed, maize bran, rice bran	0.58
Full fat rapeseed, full fat linseed, full-fat cottonseed, cottonseed meal	0.49
Oats, wheat milling by-products, corn gluten feed and other maize starch by-products, maize feed flour, sorghum	0.31
Dehydrated grass, straw	0.19
Barley	0.15
Barley rootlets, meat and bone meal	-0.18
Linseed meal, palm kernel meal, full fat soybean, soybean meal, sunflower meal, sunflower seed	-0.19
Cassava	-0.23
Faba bean, lupin, pea	-0.36
Sugar beet pulp, molasses, vinasse, potato pulp	-0.43
Whey	-0.74
Soybean hulls	-0.97
Other feed materials except starch and brewer's grains	0.00

For maize starch and brewer's grains, we used a general equation proposed by Noblet (personal communication, 2002):

$$GE = 0.2299 \text{ CP} + 0.3893 \text{ EE} + 0.1740 \text{ Starch} + 0.1655 \text{ Sugars} + 0.1884 \text{ NDF} + 0.1773 \text{ Residue}$$

The abbreviations and the units are the same as in the previous equation. The residue is the difference between organic matter and the sum of the other constituents in the equation.

Digestible energy, metabolisable energy and net energy

For pigs, ruminants, rabbits and horses, the prediction of the digestibility of energy (Ed) or organic matter (OMd) is, in most cases, based on the cell wall constituents. The relationships obtained for each species differ, as illustrated in figure 2. Therefore, it was necessary to develop specific tables.

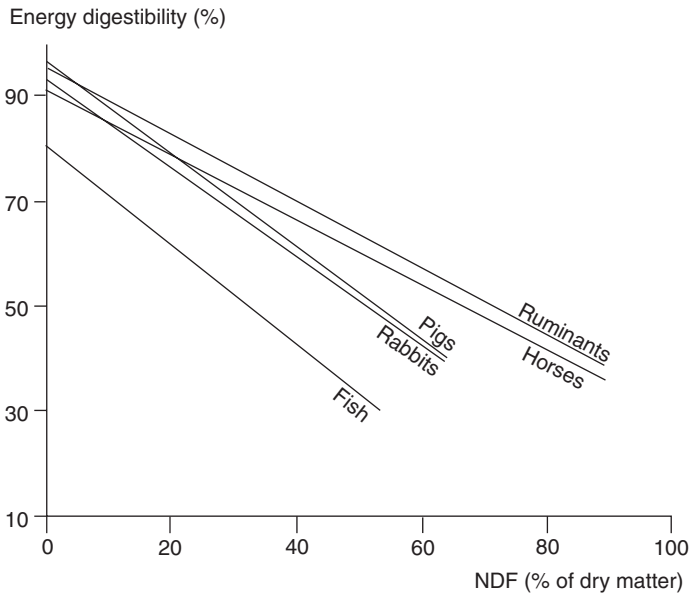

Figure 2. Comparison of the influence of cell wall content on energy digestibility for several species.

For each species, there are particular equations for the different groups of feed materials. The digestible energy (DE) value of a feed material is calculated from the gross energy and the energy digestibility value.

Metabolisable energy (ME) content is predicted using DE content and certain characteristics concerning the composition of the feedstuff linked to energy losses in the form of gas and urine. The transformation equations are specific for each type of animal. In the case of poultry, ME is measured directly since energy losses in faeces and urine cannot easily be separated.

The estimation of net energy (NE) based on ME is also performed using species specific equations and described in the relevant sections.

Nitrogen values

The values for faecal nitrogen digestibility (or crude protein digestibility) are given for all the species. In the case of rabbits and fish, these data are, in these tables, the only estimates of the nitrogen values of feed materials.

Due to the differences between species - and particularly between monogastrics and ruminants - concerning the digestive and metabolic use of ingested nitrogen, more elaborate estimations of nitrogen value are described for the different species in their respective chapters.

In the case of pigs, the tables present the values of apparent ileal digestibility for amino acids and the values for standardised ileal digestibility, corrected for measured endogenous nitrogen losses, considered to be constant. For poultry, the amino acid digestibility values represent the true faecal digestibility. They are systematically corrected for measured endogenous nitrogen losses. For ruminants, the levels of PDIA, PDIE and PDIN are indicated as well as the levels of intestinal digestible essential amino acids. For horses, protein values are expressed in terms of Digestible Crude Protein (MADC).

Mineral values

Phosphorus

The majority of phosphorus contained in plant storage organs is in a form bound to phytic acid (myo-inositol hexaphosphoric acid). The release of this phosphorus requires enzymatic hydrolysis by a phytase. Phytate phosphorus is not available for monogastric animals because they do not possess sufficient intestinal phytase activity to hydrolyse the phosphate groups of this molecule. Therefore, a large part of the phytate phosphorus is not used and can be found in the excreta. However, it is possible to improve its availability by adding exogenous phytases to the feed. In addition, plant phytases contained in some feed materials, such as wheat, can hydrolyse the phytate phosphorus in the other diet ingredients (Nys *et al.*, 1997). This problem is less important for ruminants since the microorganisms in the rumen produce phytases.

The tables present three types of nutritive values for phosphorus: apparent faecal phosphorus digestibility for the pigs (with, in some cases, different values depending on the denatured or non-denatured state of the endogenous phytase), phosphorus availability for chickens and absorbed phosphorus for ruminants.

Sources of minerals

The tables present the relative biological value of the major sources of minerals (mineral products and organo-metallic complexes) used in Europe for pigs, poultry and ruminants. This review was performed by a group of experts commissioned by the EMFEMA using all the available literature data.

References

- Carré B., Gomez J., Melcion J. P., Giboulot B., 1994. La viscosité des extraits aqueux des aliments destinés aux oiseaux d'élevage : méthodologie de mesure, effets des traitements technologiques, utilisation pour la prédiction des consommations et excréments d'eau chez le dindonneau de chair de cinq semaines. *Colloque annuel Valicentre*, 13 déc. 1994, Chambray-les-Tours, CRITT Valicentre, Orléans, 66-77.
- Nys Y., Frapin D., Pointillart A., 1997. Occurrence of phytases in plants, animal and microorganisms. In: *Phytase in animal nutrition and management: a BASF reference manual 1996*. Coelho M. B., Kornegay E. T. (ed.), BASF Corp, Ludwigshafen, 213-236.

Nutritional values for pigs

Jean Noblet, Bernard Sève and Catherine Jondreville

Energy value

Introduction

The estimation of the energy value of feed ingredients for pigs requires several steps. The first one is the estimation of digestible energy (DE), calculated as the gross energy multiplied by the apparent faecal digestibility coefficient for energy (Ed). This coefficient varies according to the characteristics of the feeds but also with the live weight of the pig. Two main physiological statuses were considered: the 50-70 kg growing pig (the data can be applied to fast growing animals between 10 to 150 kg live weight) and the adult sow (the results can be used for both gestation and lactation) (Le Goff and Noblet, 2001). The energy losses in urine are calculated using the amount of nitrogen excreted in the urine and the losses in the form of gas from degraded cell walls; the latter energy loss differs between the two physiological statuses used to estimate DE. The metabolisable energy (ME) content is the difference between the DE value and the energy losses in urine and gas. The net energy (NE) value is estimated using the equations proposed by Noblet *et al.* (1994) which can be applied to both the growing pig and the sow.

Estimation of the digestibility of energy and nutrients

Growing pig

Energy digestibility (Ed) was estimated using prediction equations specific for each feed material. These equations used one or two chemical characteristics that were variable enough and able to discriminate between different feedstuffs. These equations were established using literature values and unpublished INRA data. However, for the majority of feed materials, there were not enough original digestibility values available for a single ingredient, and we had to group the data from feed materials having similar characteristics, such as botanical origin and anatomical structure. For example, the data from wheat and its by-products (bran, shorts, middlings, gluten feed, wheat distillery by-product, etc.) were combined (n = 52) and the Ed was calculated using cell wall constituents (crude fibre, NDF or ADF) as predictors. This method is illustrated in Noblet and Le Goff (2000) for wheat and maize products. Similar equations were established for the protein digestibility coefficient (Nd). These equations are reported by Noblet *et al.* (2003) and are available in digital format at www.inapg.fr/dsa/afz/tables/energie_porc.htm.

However, for several (families of) ingredients given in the tables, there were insufficient or no data in the literature or the results had been obtained using products that had very similar compositions (i.e., no variability). It was therefore impossible to establish specific prediction equations for Ed and Nd based on chemical composition. We used either the average values calculated from literature data - if the results were consistent - or, in the case of DE, values predicted by the following global equation (Le Goff and Noblet, 2001 and Noblet, unpublished; n= 77 diets):

$$DE = 0.2247 \text{ CP} + 0.3171 \text{ EE} + 0.1720 \text{ Starch} + 0.0318 \text{ NDF} + 0.1632 \text{ Residue} \text{ (RSD} = 0.35)$$

DE is expressed in MJ/kg dry matter; CP (crude protein), EE (ether extract), NDF, starch and Residue are expressed in % dry matter. The Residue corresponds to the difference between the quantity of organic matter and the sum of the other constituents used in the equation.

For some feed materials, none of the previously described methods could be used so we chose a likely value. In all cases, Ed or DE content for each feed material were calculated using the chemical characteristics published in the tables. In addition, when several equations to predict Ed or Nd were obtained, the estimate provided by the most precise equation(s) was used.

The faecal digestibility coefficients for starch and sugars are considered to be equal to 100%, both in the growing pig and the adult sow. There is a paucity of data for faecal digestibility of fats (EEed) in the literature and the values found are sometimes incoherent and above all imprecise for products with less than 5% fat, as are the majority of the feed materials in the tables. Except for fat sources (oils and fats, see below), we decided to predict the digestible fat content (DEE) from an equation established by Le Goff and Noblet (2001) using 77 diets. EEed corresponds to the ratio between DEE and the fat content ($\times 100$). The following equation was used:

$$DEE = 0.82 \text{ EE} - 0.02 \text{ NDF} - 0.7 \text{ (RSD} = 0.33)$$

where DEE, EE and NDF are expressed in % dry matter. This equation gives very low EEed values (which can even be negative) for products with low levels of fat.

For numerous reasons, there are few reliable data concerning cell wall digestibility in the pig. Therefore, it was not possible to estimate directly the digestibility of this fraction. The indirect method used was to estimate the faecal digestibility coefficient of organic matter (OMd) or the content of digestible organic matter (DOM). Firstly, a residue (Res) which corresponds to the difference between organic matter and the sum of crude protein, ether extract, starch and sugars was calculated. Secondly, a digestible residue (DRes), equal to the difference between the DOM content and the sum of DCP, DEE, starch and sugars (calculated according to the methods described above) was also calculated. The components Res and DRes are theoretically equivalent to respectively the cell walls and the digestible cell walls. However, the values are calculated by difference and not measured directly. OMd was estimated using the following equation (Noblet, personal communication, $n = 270$ diets):

$$\text{OMd} = 7.0 + 0.955 \text{ Ed} - 0.05 \text{ DCP} - 0.03 \text{ DEE} \text{ (RSD} = 0.4)$$

The following equation has the same precision as the previous one:

$$\text{OMd} = 7.9 + 0.915 \text{ Ed} + 0.031 \text{ (Starch} + \text{ Sugars)} \text{ (RSD} = 0.4)$$

OMd and Ed are expressed in %; DCP, DEE, starch and sugars are expressed in % of dry matter.

For all feed materials with high fat content (oils and fats), the EEd, Ed and OMd were assumed to be 85%, both in the growing pig and the adult sow. This value is the same as the average of the literature values and does not take into account the potential (but unlikely) differences in digestibility associated with the degree of fatty acid unsaturation. However, it cannot be used for products rich in free fatty acids (e.g. acid oils) for which the EEd (and the Ed) are much lower. Finally, the Ed of synthetic amino acids was fixed at 100% and the DE value was therefore considered to be the same as the gross energy concentration of the pure amino acid.

Adult sow

It is stated in the literature that energy digestibility is higher for adult sows than for growing pigs. This effect depends on the quantity and botanical origin of cell walls and it clearly justifies the choice of two distinct energy values for feedstuffs (Le Goff and Noblet, 2001). However, due to a shortage of literature data, energy digestibility for the sow cannot be estimated by regression, unlike the growing pig. In addition, the few data available do not necessarily correspond with the feed materials defined in the tables. The approach described by Le Goff and Noblet (2001) in which the DE content for the sow is estimated using the DE content measured or estimated in the growing pig was possible for some families of feed materials (wheat, maize and soybean; Noblet and Le Goff, 2000 and Le Goff and Noblet, 2001). However, such equations were not available for all the feed materials in the tables. In addition, there was a risk that a bias would be introduced if the same equation were used for all feed materials.

A further analysis of the data used in the publication of Le Goff and Noblet (2001) shows that the difference in DE content between the sow and the growing pig is directly proportional to the level of indigestible organic matter in the growing pig. In their study, concerning 77 diets, an increase in the DE concentration per g of indigestible organic matter in the growing pig (DEdiff) was on average 4.2 kJ per g. This extra 4.2 kJ of DE is associated with an additional supply of 0.195 g of DOM, made up of 0.058 g DCP and 0.137 g DRes. However, a comparison of digestibility measurements in the sow and growing pig shows that the DEdiff varies according to the (families of) feed ingredients (Noblet *et al.*, personal communication). For example, DEdiff is 2.9 kJ for wheat products compared to 7.5 and 8.0 kJ for soybean and maize products, respectively. The data obtained by INRA for about 50 feed materials (Noblet *et al.*, unpublished) made possible the estimation of DEdiff for all the products in the tables (values vary between 0 to 8.4). It has also allowed the calculation of the differences in DE, DOM, DCP and DRes contents between the adult sow and the growing pig using the level of indigestible organic matter in the growing pig (as has been previously defined). It was assumed that the amount of DOM per kJ (0.047 g/kJ) and the repartition of the surplus DOM between DCP and DRes were constant whatever the value of DEdiff. The levels of DE, DOM, DCP and DRes in the adult sow were then obtained by adding the calculated differences to the levels of DE, DOM, DCP and DRes estimated in the growing pig. It was assumed that the digestibility coefficients for fat, starch and sugars are identical for the growing pig and the adult sow.

Estimation of ME content

As indicated in the introduction, the energy losses in urine (Euri) and in fermentation gases (methane; Egas) were taken into account in the calculation of the ME content of feed materials. An analysis of the data obtained in 50-70 kg growing pigs and in the adult sow ($n = 610$; Noblet,

personal communication) showed that Euri (MJ/kg ingested dry matter) depends on the quantity of nitrogen measured in the urine (Nuri; g/kg of ingested dry matter). The prediction equations are:

$$\text{Growing pig: } \text{Euri} = 0.19 + 0.031 \text{ Nuri (RSD} = 0.05)$$

$$\text{Adult sow: } \text{Euri} = 0.22 + 0.031 \text{ Nuri (RSD} = 0.05)$$

The quantity of nitrogen excreted in urine is directly proportional to the difference between the daily supply and the capacity of the pig to fix nitrogen in the form of protein. We can assume that for most stages of pig production, when the protein supply has a correct amino acid balance and meets the animal's requirements, close to 50% of digestible nitrogen is fixed or the quantity of nitrogen found in the urine represents 50% of digestible nitrogen. This assumption was applied to each feed material and for the level of DCP (N x 6.25) estimated according to the methods described above.

The quantity of energy lost in the form of gas (Egas) was calculated using the quantity of fermented cell walls. This was considered to be equal to the DRes value obtained in the nutrient digestibility method. The compilation of data obtained in respiration chambers (Le Goff, 2001) allows the estimation of Egas: 0.67 and 1.34 kJ per g of DRes in the growing pig and the adult sow, respectively.

For feed materials containing neither cell walls nor crude protein (oils and fats), this method produces a ME value which is very close to that of DE, as observed in animal experiments. The synthetic amino acids generally represent a limiting factor for nitrogen retention and it can be supposed that the retention coefficient for the nitrogen supplied by these amino acids is higher than that for total nitrogen. We have estimated it to be 65% when calculating their ME values.

Estimation of NE content

The NE content of feedstuffs has been estimated using equations established by Noblet *et al.* (1994) with 61 diets. Three equations were preferentially used:

$$\text{NE}_2 = 0.121 \text{ DCP} + 0.350 \text{ DEE} + 0.143 \text{ Starch} + 0.119 \text{ Sugars} + 0.086 \text{ DRes (RSD} = 0.25)$$

$$\text{NE}_4 = 0.703 \text{ DE} + 0.066 \text{ EE} + 0.020 \text{ Starch} - 0.041 \text{ CP} - 0.041 \text{ CF (RSD} = 0.18)$$

$$\text{NE}_7 = 0.730 \text{ ME} + 0.055 \text{ EE} + 0.015 \text{ Starch} - 0.028 \text{ CP} - 0.041 \text{ CF (RSD} = 0.17)$$

NE, ME and DE are expressed in MJ/kg dry matter. The chemical constituents are expressed in % dry matter.

Equation NE₂ is actually a variant of the equation NE₂ proposed by Noblet *et al.* (1994), as the "Weende" analysis was not used here to define the values of digestible elements. In practice, the NE value given in the tables is the average of the three NE values obtained using the above equations and applied to the feed materials for which the chemical characteristics are given in

the tables. The values of digestible nutrients or DE or ME were obtained using the methods described above. For sources of fat (oils and fats) and feed materials that contain practically only starch (maize starch), equation NE2 was used to calculate the NE value. In the case of synthetic amino acids, it was assumed that the efficiency of ME use was 85% for the fraction fixed in body protein (65% of DE) and 60% for the fraction which was deaminated (35% of DE).

Conclusion

The approach proposed for the calculation of the energy values of feedstuffs for pigs generates six energy values appropriate to the physiological status of the animal - growing pig and adult sow - according to three different systems (DE, ME and NE)

The NE system should be preferred, because it results in the estimation of an energy value which is the closest to the “true” value and thus allows the formulator to differentiate more precisely between feed materials when calculating diets. Finally, it should be noted that the NE value of a feedstuff is highly dependent on its DE and ME values, which are themselves dependent on the chemical characteristics of the feed, the animal that consumes the feedstuff and the technology used (milling, granulation etc...) to produce the diet. The values given in the tables are principally for ground feeds, rapeseeds being the sole exception: the table values are given for pelleted rapeseed as the non-pelleted form has a very low digestibility. In general, pelleting improves energy and nutrient digestibilities. However, literature data are insufficient to propose, for all the materials used in pig feeding, energy values that take into account the different types of processing, in particular pelleting.

Nutritional value of proteins and ileal digestibility of amino acids

The nutritional availability of amino acids (AA) can be estimated by measuring their digestibility at the end of the small intestine, or ileum. Indeed, in the large intestine, microorganisms can metabolise some undigested amino acids, which prevents them from appearing in the faeces. Therefore “ileal” digestibility is used. The data for apparent and standardised ileal digestibility given in the tables are derived from experiments started in the early 1980's by Adisseo, by ITCF (with the help of Ajinomoto Eurolysine) and by INRA (Rennes). These data were collated between 1996 and 1999 and published as a CD-ROM (AFZ *et al.*, 2000).

Ileal digestibility can be determined in pigs fitted with an ileal cannula, after measuring the concentrations of an indigestible marker, or in pigs with an ileo-rectal anastomosis (IRA), after collecting the totality of the ileal output. The data presented in the tables were obtained using the termino-terminal ileo-rectal anastomosis technique, validated by Laplace *et al.* (1994), where the large intestine is completely isolated. The way in which ileal digestibility is expressed depends on how the endogenous losses have been taken into account in the calculations (Sève, 1994). Both “apparent” and “standardised” digestibilities are given in the tables.

Apparent digestibility

Apparent digestibility ignores the endogenous or exogenous origin of the undigested nitrogen (N) or AA. The quantities of undigested N or AA are considered proportional to the quantity

of dry matter ingested for the feed material being studied. If the diet used for the measurements contains other ingredients, it is necessary to estimate the quantities of undigested N or AA generated by the dry matter of these ingredients. The quantities of undigestible N or AA effectively associated with the tested feed material can be calculated “by difference”. This applies when the material under test is substituted into a basal diet, which can contain protein or be protein-free, and the apparent digestibility can then be estimated as if the diet was only composed of the source of proteins being tested.

Therefore, in the case of protein-rich feed materials diluted with protein-free ingredients (starch, sugar, vegetable oil etc...) so that they are the only source of protein in the diet, the contribution of these ingredients to the indigestible fraction needs to be subtracted from the apparent undigestible value. Without this correction, the quantities of N or AA that are apparently digested for protein-rich feed materials are underestimated. In addition, the values are not additive for feed materials having a protein content low enough to make dilution unnecessary. Most of the values for apparent digestibility published to date and measured in this way are not corrected and are therefore not additive.

Standardised digestibility

The concept of biological value proposed by H. H. Mitchell in the 1920's distinguished between nitrogen losses due to dietary proteins from endogenous losses due to maintenance requirements. It is now known that these endogenous losses can vary depending on the composition of the protein source. This is why it is necessary to consider separately the basal endogenous losses. These basal losses are independent of the composition of the feedstuff being studied and are not proportional to the quantity of protein ingested. However, they can be proportional to the total quantity of dry matter ingested (figure 3)

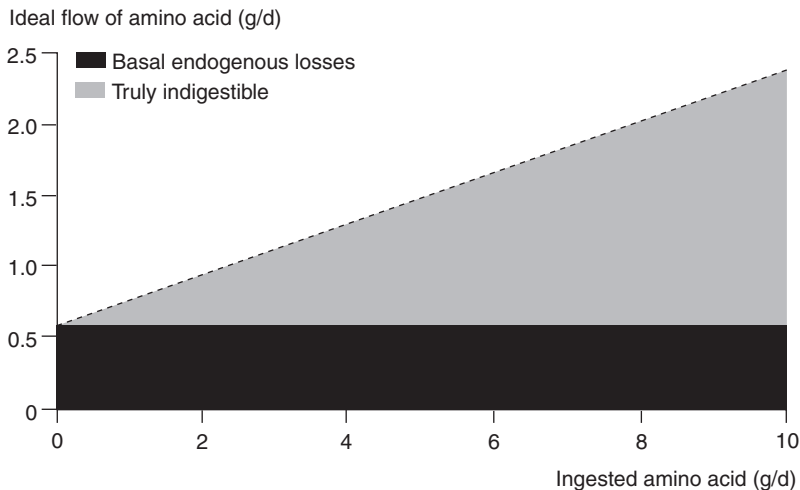

Figure 3. Effect of the quantity of ingested amino acid on the ileal flow of amino acids, at a constant level of dry matter intake.

By subtracting these losses from the measured indigestible fraction, the true digestibility, as defined by H. H. Mitchell, can be calculated. It is independent of the metabolic level of the animal. In the case of measurements performed by diluting a protein source with protein-free ingredients, it is possible to calculate, from a variable apparent digestibility, a true digestibility independent of the level of the feedstuff in the diet (figure 4).

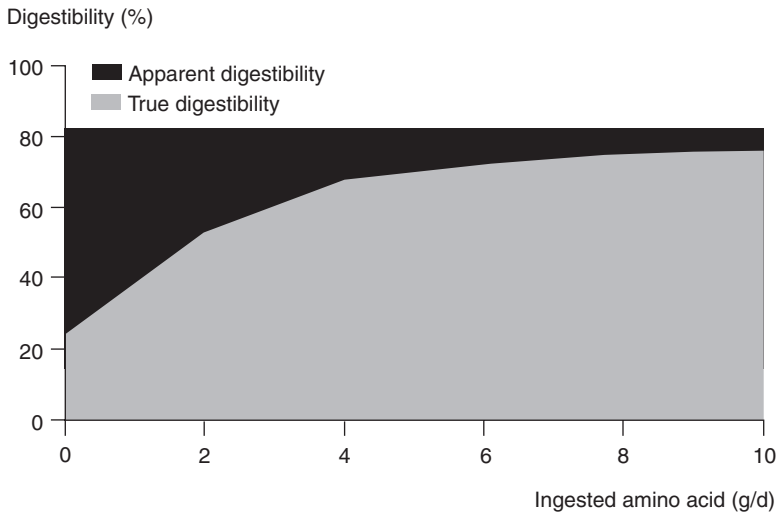

Figure 4. Effect of the quantity of ingested amino acid on apparent digestibility, at a constant level of dry matter intake.

Furuya and Kaji (1991) have shown that, contrary to the values of apparently digestible AA (not corrected), the values of “truly” digestible AA are additive. This is explained by the fact that, as is the case for the quantities of “truly” undigestible AA, they are strictly proportional to the protein content of the feed material being studied. To avoid confusion with the concept of “real” digestibility, it is now preferable to use the term “standardised digestibility”.

The standardised ileal digestibility values (SID) depend on the estimation of basal endogenous losses of N or of each AA. If the animals do not receive the diet for a long period, the use of a protein-free diet is the most appropriate method to measure these losses. It has been shown that the basal endogenous losses, when measured using protein-free diets of similar composition (Sève *et al.*, 2000), depend on the laboratory where they were measured.

Calculations

The tables provide the averages of measurements taken at three different sites. Each feed material was usually the only protein source in the diet. For each individual value of true digestibility, the apparent ileal digestibilities of the diet (AID in %) were estimated by using the basal endogenous losses characteristic of each site ($\text{EndobDMI}_{\text{site}}$), expressed in g/kg of ingested

Table 1. Basal endogenous losses (g/kg ingested dry matter) in the three laboratories that produced the digestibility data used in the tables.

Laboratory	A	B	C
Crude protein	8.66	7.22	9.67
LYS	0.29	0.24	0.41
THR	0.33	0.27	0.39
MET	0.08	0.05	0.13
CYS	0.14	0.11	0.17
TRP	0.09	0.09	0.17
ILE	0.26	0.18	0.33
VAL	0.34	0.25	0.48
LEU	0.45	0.30	0.53
PHE	0.30	0.19	0.33
TYR	0.25	0.14	0.28
HIS	0.16	0.10	0.13
ARG	0.27	0.22	0.35
ALA	0.32	0.28	0.50
ASP	0.54	0.41	0.72
GLU	0.78	0.52	0.92
GLY	0.39	0.47	0.45
SER	0.35	0.25	0.38
PRO	0.54	ND	0.53

ND = not determined

dry matter (table 1) and the AA content of the diet (AADietDM), expressed in % of dry matter. The following equation was used:

$$\text{SID} = \text{AID} + (\text{EndobDMI}_{\text{site}} \times 10/\text{AADietDM}) \quad \text{equation 1}$$

The protein-free ingredients used to dilute the feed materials were similar to those used to estimate basal endogenous losses. The corrected AID values given in the tables were calculated using the SID and AA content of the feed material (AAFMDM, in % of dry matter) using:

$$\text{Corrected AID} = \text{SID} - (\text{EndobDMI}_{\text{site}} \times 10/\text{AAFMDM}) \quad \text{equation 2}$$

This corresponds to the following relationship between the corrected apparently digestible AA content (Corrected AIDC) and the standardised digestible AA content (SIDC), both expressed per kg dry matter of the feed material:

$$\text{Corrected AIDC} = \text{SIDC} - \text{EndobDMI}_{\text{site}} \quad \text{equation 3}$$

Use of the data in formulation

The basal endogenous losses are independent of the nature of the constituents of the feed materials. They represent an expense of body nitrogen that must be covered by the diet. The standardised supply of digestible amino acids allows this requirement to be taken in account. In contrast, the corrected apparent undigestible component of the feed material simply includes the basal loss without any differentiation from the feed protein loss. Therefore, the requirement expressed in standardised digestible AA must exceed the requirement expressed in corrected apparent digestible AA, of a value at least equal to the basal endogenous loss. There are three conditions for the least cost formulation to lead to the same result whatever the mode of expression, 1) the correction of the apparent digestibility (see above), 2) the hypothesis of proportionality between basal endogenous losses and ingested dry matter, 3) the assumption that the requirement for net synthesis of the basal loss is not higher than the loss itself, meaning 100 % efficiency of digestible AA for their incorporation into endogenous protein, i.e., zero metabolic cost for this protein.

Standardised digestibility system or apparent digestibility system?

As long as basal endogenous losses can be considered to be strictly proportional to ingested dry matter for all feed materials, they can be integrated into the total losses attributable to the dry matter of the feed material. This means that the digestible AA contents, be it corrected apparent or standardised, can be used indifferently and converted from one to the other with equation 3. However, some factors related to animal feeding behaviour, physiological characteristics (live weight, age etc...) (Hess and Sève, 1999) and environment (Sève *et al.*, 2000), can significantly modify this proportionality and introduce a bias in the estimation of apparent digestibility. In addition, within the standardised digestibility system, it is possible to take into account the metabolic cost of the basal endogenous loss, which is impossible within the apparent digestibility system. Therefore, the use of the concept of standardised digestibility appears to be more pertinent than that of apparent digestibility.

Phosphorus digestibility

The principle used for the calculation of the “phosphorus value” of a feed material is its digestible phosphorus concentration. It is calculated by multiplying the total phosphorus concentration by the apparent faecal digestibility coefficient of phosphorus. The digestibility coefficients were obtained in most cases from published or unpublished results produced over the last ten years by Arvalis - Institut du Végétal (formerly ITCF, Institut Technique des Céréales et des Fourrages) using pigs weighing approximately 45 kg (Barrier-Guillot *et al.*, 1996; Chauvel *et al.*, 1997; Skiba *et al.*, 2000). We have also used additional data from the literature based on the same concept (Jongbloed *et al.*, 1993; Jongbloed *et al.*, 1999). In some cases, due to the lack of recent reliable references, the digestibility coefficient can be absent from the tables.

In some feed materials, the presence of endogenous phytase causes a problem concerning the additive nature of digestible phosphorus values calculated in this way. The endogenous phytase found in a feed material can increase not only the digestibility of its phytate phosphorus but also the digestibility of the phytate phosphorus found in the other diet ingredients. This is why two

values for apparent faecal digestibility are given for feed materials with a significant endogenous phytase activity (wheat and its by-products, rye, barley and triticale). The first value (P_d) corresponds to the feed material when phytase has been denatured, e.g. by heating. The second value ($P_{Phy,d}$), which is higher, corresponds to the same feed material in cases where it is processed in a way that does not affect phytase activity, milling for instance. Only the first value allows the calculation of additive digestible phosphorus concentrations; the second value only gives an indication of phosphorus digestibility.

Two steps are therefore necessary in order to estimate the concentration of apparent digestible phosphorus in a diet. In the first step, apparent digestible phosphorus is estimated in a diet made up of feed materials where the phytase has been denatured. This is done by multiplying the phosphorus content of each feed material by its apparent faecal digestibility. The second step is to take into account the phytase activity of the diet by adding to the previously calculated value an estimation of the quantity of apparent digestible phosphorus released by the phytase present in the diet. The second step is problematic for several reasons. Firstly, the phytase activity in a given feed material is variable. Secondly, the phytase present in a diet is sensitive to any technological treatments it has undergone. Finally, in the case of plant phytase, the estimation of a relationship between phytase activity and the level of apparent digestible phosphorus remains difficult in the light of present knowledge.

References

- AFZ, Ajinomoto Eurolysine, Aventis Animal Nutrition, INRA, ITCF, 2000. *Ileal standardised digestibility of amino acids in feedstuffs for pigs (AmiPig)*. Association Française de Zootechnie Ed., Paris (France). CD-ROM.
- Barrier-Guillot B., Casado P., Maupetit P., Jondreville C., Gatel F., 1996. Wheat phosphorus availability: 2. In vivo study in broilers and pigs; relationship with endogenous phytasic activity and phytic phosphorus content in wheat. *J. Sci. Food Agric.*, 70, 69-74.
- Chauvel J., Granier R., Jondreville C., Williatte I., 1997. *Use of isophosphorus diets differing in phytase activity: effects on phosphorus digestibility, growth performance, bone resistance and phosphorus excretion in growing-finishing pigs*. 48th Annual Meeting of the European Association of Animal Production (EAAP), Vienna, Austria, 25-28 August 1997.
- Furuya S., Kaji Y., 1991. Additivity of the apparent and true digestible amino acid supply in barley, maize, wheat or soya bean based diets for growing pigs. *Anim. Feed Sci. Technol.*, 32, 321-331.
- Hess V., Sève B., 1999. Effect of body weight and feed intake level on basal endogenous losses in growing pigs. *J. Anim. Sci.*, 77, 3281-3288.
- Jongbloed A. W., Everts H., Kemme P. A., 1993. Phosphorus availability and requirements in pigs. In : *Recent developments in pig nutrition*, 2nd edition, Cole D.J.A., Haresign W., Garnsworthy P.C. (Eds), Nottingham University press, Loughborough, UK, 163-178.
- Jongbloed A. W., Everts H., Kemme P. A., Mroz Z., 1999. Quantification of absorbability and requirements of macroelements. In : *Quantitative biology of the pig*, Kyriazakis I. (Ed), CAB International, Edinburgh, UK, 275-298.
- Laplace J. P., Souffrant W. B., Hennig U., Chabeauti E., Février C., 1994. Measurement of precaecal dietary protein and plant cell wall digestion in pigs; comparison of four surgical procedures. *Livest. Prod. Sci.*, 40, 313-328.
- Le Goff G., 2001. *Etude des mécanismes impliqués dans l'évolution de la digestion et de l'utilisation métabolique des fibres alimentaires au cours de la vie du porc ; conséquences sur l'estimation de la valeur énergétique des aliments*. Thèse de Doctorat de l'Ecole Nationale Supérieure Agronomique de Rennes.

- Le Goff G., Noblet J., 2001. Comparative digestibility of dietary energy and nutrients in growing pigs and adult sows. *J. Anim. Sci.*, 79, 2418-2427.
- Noblet J., Shi X. S., Fortune H., Dubois S., Lechevestrier Y., Corniaux C., Sauvant D., Henry Y., 1994. Teneur en énergie nette des aliments chez le porc: mesure, prédiction et validation aux différents stades de sa vie. *Journées Rech. Porcine en France*, 26, 235-250.
- Noblet J., Fortune H., Shi X. S., Dubois S., 1994. Prediction of net energy value of feeds for growing pigs. *J. Anim. Sci.*, 72, 344-354.
- Noblet J., Le Goff G., 2000. Utilisation digestive et valeurs énergétiques du blé, du maïs et leurs co-produits chez le porc en croissance et la truie adulte. *Journées Rech. Porcine en France*, 32, 177-184.
- Noblet J., Bontems V., Tran G., 2003. Estimation de la valeur énergétique des aliments pour le porc. *Prod. Anim.*, 16: 197-210.
- Sève B., 1994. Alimentation du porc en croissance: intégration des concepts de protéine idéale, de disponibilité digestive des acides aminés et d'énergie nette. *Prod. Anim.*, 7, 275-291.
- Sève B., Tran G., Jondreville C., Skiba F., Van Cauwenberghe S., Bodin J.C., Langer S., 2000, Measuring ileal basal endogenous losses and digestive utilisation of amino acids through ileo-rectal anastomosis in pigs: ring test between three laboratories. In: *Digestive physiology of pigs*, J.E. Lindberg and B. Ogle Eds, Proceedings of the 8th. International symposium on digestive physiology in pigs, 2000/06/20-22, Uppsala (SWE), p. 195-197, CABI Publishing, Oxon, UK.
- Skiba F., Hazouard I., Bertin, J. M., Chauvel J., 2000. Digestibilité du phosphore de 14 matières premières et influence de la phytase végétale dans l'alimentation du porc charcutier. *Journées Rech. Porcine en France*, 32, 169-175.

Nutritional values for poultry

Michel Lessire

Energy Value

In birds, digestible energy is not used to characterise the fraction of ingested gross energy available to the animal since the faeces and urine are excreted together through the cloaca. Conversely, metabolisable energy (ME) is relatively easy to measure and is thus the most used energy system. It is calculated as:

$$ME = (GE_i - GE_e)/Q_i$$

where GE_i and GE_e are respectively the ingested and excreted gross energy and Q_i is the quantity of feed ingested. In birds, losses by gases are negligible. The *in vivo* measurement of ME requires a digestive balance experiment in which the quantities ingested and excreted and the gross energy content of the diet and dehydrated excreta are precisely determined. This “total collection” technique is preferred to methods involving a marker introduced in the feed.

ME can be described as apparent or true and as corrected or uncorrected for nitrogen balance. Apparent or classic ME (AME) does not take into account the endogenous losses that do not come directly from the ingested diet but are composed of digestive secretions, intestinal desquamation, bacterial bodies, nitrogenous constituents originating from protein catabolism, etc. Therefore, AME underestimates the energy value of feeds when intake is low since, in these conditions, endogenous losses in excreta become proportionally more important compared to high feed intakes. In order to calculate ME values that are independent from the intake level, Guillaume and Summers (1970) proposed that endogenous losses should be subtracted from total losses in excreta.

True ME (TME) can be calculated from the equation:

$$TME = (GE_i - (GE_e - E_e))/Q_i = AME + E_e/Q_i,$$

where E_e is the excreted endogenous energy voided by the cockerel during a digestive balance experiment.

This concept was used by Sibbald (1976) to develop a rapid and miniaturised method to measure the “true” energy value of feeds in adult cockerels.

Apparent or true ME does not allow comparison between birds when production levels are different and in particular when protein retention is different. Indeed, if all the ingested protein was used for synthesis, resulting in no nitrogen excretion, the nitrogen balance would be positive. In the opposite case, if all the ingested protein was catabolised this would result in zero nitrogen balance. Negative nitrogen balances are also possible when the animal excretes more nitrogen than it consumes (fasting or feed restricted animals).

Due to production level - growth or egg production - the growing chicken or laying hen can therefore have ME values higher than those observed in the adult cockerel, which is on average at zero nitrogen balance. Therefore, the correction of ME for nitrogen retention in birds allows the comparison between animals and improves measurement precision since in a group of birds the nitrogen balance is variable.

This balance can be measured or estimated. The measurement consists in determining the nitrogen content of the diet and excreta. The nitrogen balance (ΔN) can be calculated by:

$$\Delta N = Q_i \times N_i - Q_{ex} \times N_{ex}$$

Q is the quantity and N is the concentration of nitrogen in the diet when ingested (i) and excreted (ex).

The nitrogen balance could be estimated by measuring the live weight gain (LWG) of birds during the balance experiment, assuming that the gain contains 20% protein i.e. 3.2% (20 / 6.25) nitrogen. The level of body protein, feathers included, varies according to the age of the bird. The nitrogen balance can then be calculated by:

$$\Delta N = LWG \times 0.20 / 6.25$$

In order to calculate ME at zero nitrogen balance, it is assumed that uric acid is the major constituent of excreted urinary nitrogen and that the quantity of energy corresponding to 1 g of excreted nitrogen in the form of uric acid is 34.4 kJ (or 36.5 kJ according to some authors). Therefore, ME (MJ/kg) at zero nitrogen balance (AMEn) can be calculated by:

$$AMEn = AME - 0.0344 \Delta N / Q_i$$

In the same way, TMEn can be calculated after having estimated the non-nitrogen endogenous energy losses: $E_{enn} = E_e - 0.0344 \Delta N$. These losses, which exclude nitrogen losses, only represent a few kJ per cockerel per day.

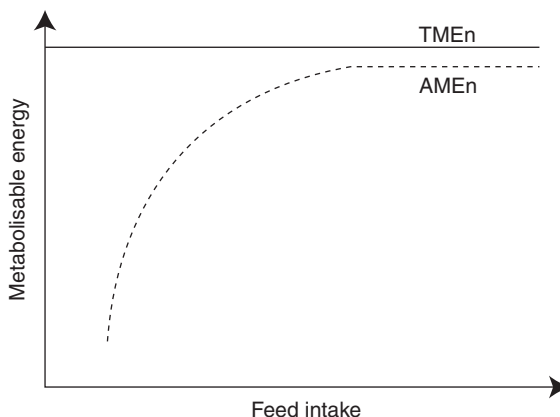

Figure 5. Relationship between AMEn, TMEn and feed intake.

$$\text{TME}_n = \text{AME}_n - 0.0344 \Delta N / Q_i + E_{\text{enn}} / Q_i$$

In conclusion, TME_n is the best estimation of the metabolisable energy of a diet because it is independent of the level of ingestion and does not take into account the endogenous fraction that does not come directly from the diet. Theoretically, only TME_n values are additive. However, when ingestion levels are close to spontaneous ingestion levels in the birds, AME_n and TME_n are similar.

In practice, *ad libitum* feeding of birds is the most commonly used feeding method in Europe for all types of birds: growing chickens, turkeys or adult cockerels. A reference protocol was published at the beginning of the 1990's (Bourdillon *et al.*, 1990) and each laboratory, including INRA, has since simplified the method. The birds are accustomed to the experimental diet over a 3-day period. Then they are fasted for a period varying from one night for young chickens to 24 hours for cockerels. Once the excreta collection system is installed, the birds are fed for two days and then fasted again. The totality of the excreta is collected during the last three days of the balance period.

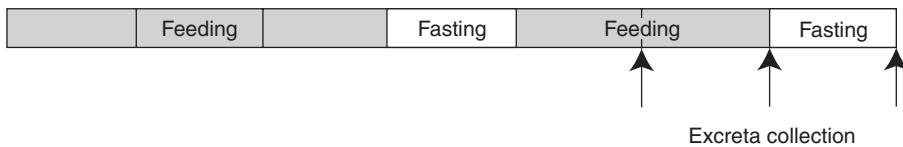

Figure 6. Protocol for the measurement of metabolisable energy used by INRA.

Under these conditions, the levels of ingestion are high when the diets are palatable and only the AME_n is determined. Unlike force-feeding methods, this protocol is not suitable when the feed material is fed alone and poorly or not consumed. Therefore, it is necessary to replace part of the reference diet by an equivalent amount of the feed material to be tested and its ME is calculated by difference, assuming that the values are additive. The levels of incorporation of the feed materials depend on their nature and on their practical conditions of use. For instance, maize can represent 96% of the diet while fats only represent a few %. For this latter type of ingredient, several levels of incorporation are generally used to assess whether there is a synergy between feed materials and to improve the precision, which is inversely proportional to the level of incorporation.

The two energy values presented in the tables are ME values at zero nitrogen balance (AME_n). One is for the adult cockerel, which serves as a reference in many laboratories, and the other is for a 3 week-old chicken. Chicken and cockerel differ as lower digestibilities of fats and starch are observed in the younger animal. In order to obtain the AME values, it is necessary to know or calculate nitrogen retention, which can be as high as 40 %, and multiply it by the nitrogen concentration (g/kg) of the diet or feed material and then multiply it by 0.0344 MJ. The result obtained is added to the AME_n value.

The ME values published in the tables are calculated from the averages obtained in *ad libitum* feeding conditions. They result from research organisations using a digestive balance technique very similar to the one described above. The averages have then been corrected by equations

(Carré and Rozo, 1990; Fisher and McNab, 1987) taking into account the average chemical composition given in the tables. They are metabolisable energy values at zero nitrogen balance.

Protein value

The nutritional value of a protein mainly depends on its amino acid composition. However, proteins can be associated with other components such as carbohydrates and they can also be altered by heat treatment, resulting in less efficient digestive enzyme action. Under these conditions, the digestibility and the metabolic utilisation of dietary proteins vary greatly according to the feed materials and their technological treatments. Therefore, the simple chemical analysis of amino acid composition is not sufficient to judge the quality of a feed material. A more appropriate system of expression is that of amino acid availability; it is defined as the proportion of an amino acid that is truly usable by the animal. However, it is only used for limiting amino acids.

Chemical and biological methods can be used to estimate this parameter. Only the latter methods have a large range of applications and are able to generate data for all sources of proteins and their constituent amino acids.

Growth tests measure the ability of a protein to replace an essential amino acid, particularly lysine, in the diet of a growing chicken. A regression equation between growth rate and the quantity of lysine ingested is established, using lysine-deficient experimental diets supplemented with increasing proportions of synthetic HCl-lysine (supposed to be 100% available). At the same time, other groups of chickens receive diets formulated with increasing quantities of the tested feed material, which should be the only source of lysine. The growth rates of these animals are then compared to those of animals receiving the synthetic lysine.

This method allows the measurement of the availability of a single amino acid at once and was principally developed for lysine. It does not take into consideration the possible interactions with the other constituents of the feedstuff being tested, particularly anti-nutritional factors.

In vivo digestibility methods enable the characterisation of all the dietary amino acids. They consist in the determination of the proportion of each amino acid that is not eliminated in the excreta. These methods correspond to a digestive balance test where the quantities of each amino acid ingested and excreted are measured, either at faecal or ileal level. In practice, measurement of amino acid digestibility is based on the digestive balance method. As for metabolisable energy, apparent or true digestibilities can be calculated. However, the measurement of endogenous losses raises methodological questions. Are endogenous losses specific for each feed material? Should a protein-free diet or fasted birds be used? Should regression equations be used? Finally, what should be the level of feed intake, what should be the composition of the diet (complete diet, feed material), and should animals without caeca be used?

These methodological problems have yet to be solved and there is no recognised reference method.

The method published by Terpstra and de Hart (1974) allows the estimation of the quantity of undigested dietary protein and therefore to calculate global digestibility. It consists in chemically separating urinary nitrogen from undigested protein nitrogen, both of which are simultaneously eliminated at the cloaca. Firstly, uric acid is solubilised and then undigested proteins are precipitated using lead acetate. The proteins are measured by the Kjeldhal method. However, not all the faecal nitrogen is precipitated and, conversely, some urinary nitrogen could be precipitated. Correction factors have thus been applied:

$$\text{Total N} = 1.18 \times \text{precipitated N}$$

Surgical techniques involving an artificial anus have also been proposed but they are rarely used.

Over the last few years, INRA has performed many measurements of true amino acid digestibility using intact adult cockerels (Zuprizal *et al.*, 1990). As the birds were force-fed with the amount of diet required to cover protein requirements, the proportion of endogenous losses in the excreta was very low; the endogenous losses were estimated using fasted animals. The tables present these values as well as those obtained using the same system and similar methods.

Phosphorus availability

The availability of plant phosphorus was long considered to be 30%, but numerous studies have shown this parameter to be highly variable, as it depends on endogenous phytase activity, on the proportion of phytate phosphorus in the feed materials and on the technological processes undergone by the feeds. The availability corresponds to the percentage of phosphorus utilised by the animal in comparison to a source of available phosphorus, usually monocalcium phosphate.

One of the biological criteria used to estimate availability is bone mineralization, since practically all the phosphorus contained in the body is found in the skeleton. Young birds are fed with semi-synthetic diets, either deficient in phosphorus or supplemented with increasing levels of mineral phosphorus (monocalcium phosphate), which is thought to be 100% available. A dose-response curve is obtained by plotting the quantity of phosphorus ingested versus an indicator of mineralization such as tibia ash content. At the same time, different groups of animals are fed with experimental diets where the tested feed material is the only source of phosphorus, and a dose-response curve is calculated between ingested phosphorus and bone mineralization. In order to obtain linear relationships, all the diets are formulated to maintain the birds in a state of phosphorus sub-deficiency. The availability of phosphorus for the tested feed material is equal to the ratio of the two regression slopes thus calculated (figure 7). This is the most commonly used method.

Phosphorus availability is therefore a relative value compared to a reference. It is not a digestibility and does not correspond to the quantity of phosphorus liberated in the intestinal contents. It is determined for the most sensitive parameter - bone mineralization - and by using animals in a state of phosphorus sub-deficiency in order to produce a linear response zone. The availability values presented in the tables are obtained using the method described above.

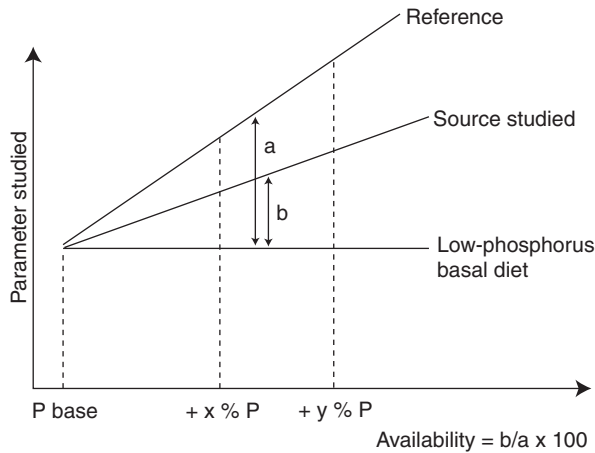

Figure 7. Method used to calculate phosphorus availability.

It is also possible to measure phosphorus retention by a digestive balance method. The phosphorus availability values thus obtained are higher than those found using the bone mineralization method.

Finally, phosphorus availabilities for feed materials are only partially additive, due to the curvilinear response of hydrolysis of phytate phosphorus to increasing phytase supplementation. In addition, plant phytase activity only corresponds to 60% of that of microbial phytase. A solution to these problems could be to estimate phosphorus availability by considering, firstly, the non-phytate phosphorus and secondly, by estimating the proportion of phytate hydrolysed from total phytate phosphorus and from phytase activity in the diet after heat treatment.

References

- Bourdillon A., Carré B., Conan L., Duperray J., Huyghebaert G., Leclercq B., Lessire M., McNab J. M., Wiseman J., 1990. European reference method for the *in vivo* determination of metabolisable energy with adult cockerels: reproducibility, effect of food intake and comparison with individual laboratory methods. *Brit. Poultry Sci.*, 31, 557-565.
- Carré B., Rozo E., 1990. La prédiction de la valeur énergétique des matières premières destinées à l'aviculture. *Prod. Anim.*, 3, 163-169.
- Fisher C., McNab J., 1987. Techniques for determining the metabolisable energy (ME) content of poultry feed. In: *Recent advances in animal nutrition*. 1987. Haresign W. and Cole D. J. A. Eds. Butterworths, London, 3-18.
- Guillaume J., Summers J. D., 1970. Maintenance energy requirement of the rooster and influence of plane of nutrition on M.E.. *Can. J. Anim. Sci.*, 50, 363-369.
- Sibbald I. R., 1976. A bioassay for true metabolizable energy in feedingstuffs. *Poult. Sci.*, 55, 303-308.
- Terpstra K., De Hart N., 1974. The estimation of urinary nitrogen and fecal nitrogen in poultry excreta. *Z. Tierphysiol., Tierernähr. Futtermittelkd.*, 32, 306-320.
- Zuprizal, Larbier M., Chagneau A. M., Lessire, M., 1990. Bioavailability of lysine in rapeseed and soyabean meals determined by digestibility trial in cockerels and chick growth assay. *Anim. Feed Sci. Technol.*, 35, 237-246.

Nutritional values for ruminants

Daniel Sauvant, Patrick Chapoutot, Jean-Louis Peyraud, François Meschy and Brigitte Doreau[†]

Digestibility and energy value

Source of data and harmonisation of digestibility values

The digestibility and energy values for ruminants presented in the tables have been established using a database of digestibility measurements obtained *in vivo* on more than 300 feed samples studied by INRA (France) and by the Rowett Research Institute (United Kingdom).

Since the digestibilities of organic matter (OMd), dry matter (DMd) or energy (Ed) were not available simultaneously for every feed sample, it was necessary to work on a unique parameter: OMd was present for 89% of the samples and the missing OMd values were calculated by regression equations using Ed or DMd as predictors. These equations integrated additional analytical characteristics when they were statistically significant.

Calculation of organic matter digestibility values for feed materials

With OMd values available for each feed material, we studied prediction models based on cell wall parameters (crude fibre, NDF, ADF) for this digestibility. Many of the resulting equations have crude fibre as the main predictor, as this parameter was the most frequent cell wall criterion in the database.

Regressions integrating discriminating tests between groups of feed materials within the same relationship were calculated by variance-covariance analysis. Interactions between the predictor and the groups were also tested in order to identify the possible effects of the type or family of feed materials on the regression slope. Therefore, six major prediction models concerning the following groups of ingredients were calculated.

Cereal grains and cereal by-products

$$\text{OMd} = 95.81 - 1.911 \text{ CF} + \alpha \quad (n = 124; r = 0.93; \text{RSD} = 3.7)$$

Where $\alpha = -2.54$ all feed materials except maize by-products

$$\alpha = +2.54 \quad \text{maize by-products}$$

Full fat rapeseed, full fat sunflower, full fat cottonseed, copra meal, palm kernel meal and cottonseed meal

$$\text{OMd} = 97.51 - 1.498 \text{ CF} \quad (n = 29; r = 0.79; \text{RSD} = 6.5)$$

Legume and oil seeds, groundnut meal and soybean meal

$$\text{OMd} = 87.75 - 0.314 \text{ CF} + \alpha \quad (n = 46; r = 0.74; \text{RSD} = 3.8)$$

Where $\alpha = -4.36$ full fat soybeans

$\alpha = -1.86$ groundnut meal

$\alpha = +6.2$ other legume and oil seeds, soybean meal

Sugar beet pulp and citrus pulp

Sugar beet pulp:

$$\text{OMd} = 87.20 - 0.951 (\text{CF} - 16.39)$$

Citrus pulp:

$$\text{OMd} = 84.11 - 1.374 (\text{CF} - 16.39)$$

For the two groups: $n = 34$; $r = 0.86$; $\text{RSD} = 2.0$

Cassava, molasses, vinasse and potatoes

$$\text{OMd} = 97.81 - 1.12 \text{NDF} \quad (n = 5; r = 0.98; \text{RSD} = 2.6)$$

Dehydrated forages

Alfalfa:

$$\text{OMd} = 65.90 - 0.919 (\text{ADF} - 29.83)$$

Grasses:

$$\text{OMd} = 74.13 - 1.364 (\text{ADF} - 29.83)$$

For the two groups: $n = 32$; $r = 0.86$; $\text{RSD} = 3.6$

In these equations, CF (crude fibre), NDF and ADF are expressed in % dry matter and OMd in %.

The residual standard deviations for these equations were between 2 and 4% of OMd. The equations were then applied to the chemical composition of the feed materials presented in the tables. With this method, we obtained consistent values for OMd for more than 85% of the feed materials. In the case of some rarely used by-products, no recent data of *in vivo* digestibility were available, and we derived their digestibility values from the tables of Becker and Nehring (1965), an old but well-documented source of feed information.

Calculation of fatty acid digestibility

In order to estimate the digestibility of fatty acids, we used an equation (Sauvant and Bas, 2001) based on a quantitative review of literature data:

$$FA_{duo} = 0.83 FA_{feed} + 0.84 \quad (n = 116; \text{number of trials} = 38; r = 0.97; RSD = 0.54)$$

FA_{duo} is the duodenal flow of fatty acids (% dry matter intake) and FA_{feed} is the fatty acids content in the feed materials (% dry matter intake). The intestinal digestibility of fatty acids was assumed to be 75%.

Fatty acid digestibility (FAd in %) is calculated by:

$$FAd = 100 \times (FA_{feed} - (1 - 0.75) \times FA_{duo}) / FA_{feed}$$

$$\text{Or: } FAd = 79 - (21 / (EE \times FA/EE \text{ coefficient} / 100))$$

EE is ether extract in % dry matter. The FA/EE coefficient is the percentage of fatty acids in the ether extract (expressed in %).

It should be noted that some digestibility values were negative, for example for low-fat feed materials, due to the fact that rumen microorganisms synthesize fats. These negative values were not published in the tables.

Calculation of energy values

The calculations of energy values were performed using the approach and the equations proposed by INRA (INRA, 1978; INRA, 1988; Vermorel *et al.*, 1987). UFL and UFV values were calculated for each feed material in the tables: UFL (Unité Fourragère Lait, feed unit for milk production) is the energy unit for lactating ruminants or slow growing ruminants; UFV (Unité Fourragère Viande, feed unit for meat production) is the energy unit for medium to fast growing ruminants. One UF corresponds to the energy value of a kilogramme of standard barley.

Energy digestibility (Ed)

Ed was calculated from OMD and chemical components using regression equations obtained from the database cited above:

$$Ed = OMD - 3.94 + 0.104 CP + 0.149 EE + 0.022 NDF - 0.244 Ash$$

$$(n = 183; r = 0.68; RSD = 1.5)$$

$$Ed = OMD - 3.50 + 0.046 CP + 0.155 EE$$

$$(n = 216; r = 0.35; RSD = 1.8)$$

$$Ed = OMD - 2.90 + 0.051 CP$$

$$(n = 250; r = 0.35; RSD = 2.0)$$

Ed and OMD are expressed in %; the chemical constituents (CP: crude protein; EE: ether extract; Ash: minerals) are expressed in % dry matter.

The choice between the different equations is based on the availability of analytical data and the most precise equation should be used.

Digestible and metabolisable energy levels

Digestible energy: $DE = GE \times Ed / 100$

Metabolisable energy: $ME = DE \times \frac{ME}{DE}$

$100 ME / DE = 86.38 - 0.099 CFo - 0.196 CPo$

GE: gross energy in MJ/kg dry matter; CFo: crude fibre in % of organic matter; CPo: crude protein in % of organic matter.

Metabolisable energy concentration of the feed: $q = \frac{ME}{GE}$ ($0 < q < 1$)

The coefficient q is used in the equations below.

Efficiency of utilisation of metabolisable energy for net energy

The coefficients kl, km and kf are comprised between 0 and 1.

For lactation: $kl = 0.60 + 0.24 (q - 0.57)$

For maintenance: $km = 0.287 q + 0.554$

For fattening: $kf = 0.78 q + 0.006$

For maintenance and meat production: $kmf = \frac{km \times kf \times 1.5}{kf + 0.5 \times km}$

UFL and UFV values

UFL value = $\frac{ME \times kl}{7.12}$

UFV value = $\frac{ME \times kmf}{7.62}$

The NE values of the reference barley were kept at 7.12 and 7.62 MJ/kg for milk and meat production respectively, even though the most recent NE values for average barley are 6.76 and 7.08 MJ/kg as fed respectively.

Comparison to previous tables

The chemical composition and the digestibility values in the present tables were compared to the ones in previous tables: the INRA 1988 tables, the Dutch tables from CVB (2000) and older German tables (Schiemann *et al.*, 1971).

The proposed composition vectors are in general highly correlated with those that we published in 1988. However, there are some significant variations for certain feed materials. The organic matter digestibilities are well correlated with those from the previous French, Dutch and

German tables. However, the regression residuals indicate that digestibility can vary significantly for some feed materials, with notable consequences on their energy values.

Nitrogen values

The apparent nitrogen digestibility values (Nd) of the feed materials in the database were quite variable, as they had been calculated using the difference method. Therefore, the Nd values were calculated using the following prediction equation for undigested crude protein (UDCP in % dry matter):

$$\text{UDCP} = 0.519 + 0.178 \text{ CP} + 0.095 \text{ UDOM} - 0.036 \text{ ADF} \quad (n = 575; r = 0.68; \text{RSD} = 0.84)$$

This equation was obtained using various diets for cattle in different physiological statuses. Crude protein (CP), undigested organic matter (UDOM) and ADF are in % dry matter (Sauvant and Mertens, unpublished).

The Nd values were then calculated by:

$$\text{Nd} = 100 \times (\text{CP} - \text{UDCP}) / \text{CP}$$

The nutritional values for nitrogen are expressed as digestible protein in the intestine or PDI (Protéines digestibles dans l'intestin, in g/kg). Three PDI values are indicated (INRA, 1978 and INRA, 1988):

- PDIA, of feed origin, included in PDIE and PDIN.
- PDIE, when energy is the limiting factor for rumen microbial activity.
- PDIN, when nitrogen is the limiting factor for rumen microbial activity

Calculation of *in sacco* degradability

In order to update the data published in 1988, we collated the kinetics of nitrogen degradability measured in three laboratories: the URH at Theix (n = 112 samples and 32 feed materials), the UMR INRA-ENSAR Production du lait in Rennes (n = 76 samples and 21 feed materials) and the UMR INRA-INA P-G Physiologie de la nutrition et alimentation in Paris (n = 283 samples and 92 feed materials). Data from the Glon-Sanders laboratory (n = 113 samples and 29 feed materials), already used in the INRA 1988 tables, were used again because of the diverse nature of the feed materials. For the same reason, literature data (139 references, 1305 samples and 178 feed materials) were also taken into account. The data were treated by analysis of variance to obtain, for each feed material, values for "effective degradability" of nitrogen (NED) corrected for laboratory bias. Similar approaches were used for the kinetic parameters a, b and c described below. For a certain number of ingredients that were absent or poorly represented in the databases, groups of reliable data were taken from the literature. This survey also provided original and useful information on the effects of some technological treatments.

The 3 basic parameters a, b and c for the kinetics of *in situ* nitrogen disappearance were included when the data was available:

- nitrogen degradability (%) at time t: $a + b \times (1 - e^{-ct})$
- a: immediately degradable nitrogen fraction (%)
- b: potentially degradable nitrogen fraction (%)
- c: hourly rate of nitrogen particle degradation (h^{-1}).

The nitrogen effective degradability (NED in %) is calculated by:

$$NED = a + ((b \times c)/(k + c))$$

Where k is the hourly rate of particle disappearance from the rumen, fixed at $0.06 h^{-1}$.

Calculation of intestinal digestibility values for rumen undegradable protein

The values for true intestinal digestibility (TId) of rumen undegradable protein (RUP) were calculated when possible using the results obtained by the technique of mobile nylon bags in the intestine (UMR INRA-ENSAR). In order to increase the diversity of the feed materials, these data were completed by measurements performed using a similar methodology by around 15 other laboratories renowned for their reliability. To be included, each laboratory had to have tested at least 10 feed materials.

The 388 values collected (corresponding to 72 feed materials) were analysed by analysis of variance to obtain TId values corrected for laboratory bias. This also enabled the quantification of the effects of some technological treatments.

The quantities of RUP undigested in the intestine (RUPUI) were estimated by the nylon bag technique ($RUPUI = RUP \times (1 - TId / 100)$). We verified that this fraction corresponded with the true undigestible RUP by establishing a relationship between the quantities of crude protein not digested in the digestive tract [$UDCP = CP \times (1 - Nd / 100)$] on one side, and the fermentable nitrogen fractions in the rumen [$FCP = CP \times NED / 100$] not digested in the intestine, the digestible organic matter (DOM) and the indigestible organic matter (UDOM) on the other side:

$$UDCP = RUPUI + 0.24 FCP + 0.36 UDOM + 0.057 DOM \quad (n = 54; r = 0.87; RSD = 10.9)$$

UDCP, RUPUI, FCP, UDOM and DOM are expressed as % dry matter

The true digestibility in the intestine of RUP is calculated as $TId = 100 \times (RUP - RUPUI) / RUP$.

For feed materials without a measured TId value, the digestibility was estimated from the equation:

$$TId = 88.3 + 0.371 CP - 0.0037 CP^2 - 1.07 ADL - 0.313 UDOM \quad (n = 69; r = 0.95; RSD = 4.7)$$

TId is expressed in %.

CP and ADL are expressed in % dry matter.

The TId values obtained by this equation were rounded up or down to multiples of 5.

Calculation of PDI values for feed materials

The equations proposed in 1988 (Verité *et al.*, 1987 and INRA, 1988) have been used to calculate the values of PDI for the different feed materials:

$$\text{PDIA} = \text{CP} \times [1.11 (1 - \text{NED})] \times \text{TId}$$

$$\text{PDIMN} = \text{CP} \times [1 - 1.11 (1 - \text{NED})] \times 0.9 \times 0.8 \times 0.8$$

$$\text{PDIME} = \text{FOM} \times 0.145 \times 0.8 \times 0.8$$

$$\text{PDIE} = \text{PDIA} + \text{PDIME}$$

$$\text{PDIN} = \text{PDIA} + \text{PDIMN}$$

with CP: crude protein in g/kg dry matter
 NED: nitrogen effective degradability in the rumen ($0 < \text{NED} < 1$)
 TId: true digestibility of RUP in the small intestine ($0 < \text{TId} < 1$)
 FOM: fermentable organic matter in the rumen, in g/kg dry matter, where FOM = digestible organic matter - ether extract - non degradable crude protein (*a priori* $\text{CP} \times (1 - \text{NED})$)

When a feed material contained more than 10% starch, the level of FOM was reduced to take into account the starch fraction that escapes rumen digestion. The multiplication coefficient used for FOM was 0.6 for maize, sorghum and rice, and 0.8 for peas, faba beans, potato pulp, whole potatoes, full fat and extracted rice bran, maize germ meals, maize bran and cassava. A value of 0.95 was used for all the other feed materials containing more than 10% starch.

Digestible amino acids in the intestine

The values of digestible amino acids in the intestine were calculated using the method proposed by Rulquin *et al.* (2001a and b). The values indicated in the present tables are not exactly the same as the values published in previous tables since the values of crude protein, amino acids, nitrogen degradability and RUP digestibility (TId) have all been updated. Nine essential amino acids have been taken into account: lysine, methionine, leucine, histidine, phenylalanine, threonine, isoleucine, valine and arginine.

Degradability of dry matter and starch

Kinetic parameters of *in sacco* dry matter degradation, which is often measured along with nitrogen degradation, have been indicated. The short-term degradability of dry matter is of particular interest as it gives an idea of the acidogenic activity of the feed material in the rumen. Finally, kinetic parameters of *in sacco* degradability of starch have been proposed for starch-rich feed materials, using the literature review by Offner *et al.* (2003), which updates the values

previously published by Sauvant *et al.* (1994). Unlike the values for nitrogen and dry matter degradability, most of the starch degradability values were taken from a literature review and not from INRA studies. The starch degradation data can be used to estimate the flow of glucose absorbed in the intestine (Nocek and Tamminga, 1991; Sauvant *et al.*, 1994; Sauvant, 1997), and also to modify the level of fermentable organic matter of feed materials containing large amounts of rumen undegraded starch, as has been done with the Dutch version of the PDI system (Tamminga *et al.*, 1994).

Absorbed phosphorus

For the first time, values for absorbed phosphorus (g/kg) are published together with the classic total phosphorus values (g/kg) and INRA will propose a new system for dietary recommendations expressed in absorbed (net) phosphorus for ruminants. Only absorbed phosphorus can cover the net physiological requirements of animals. The data come from measurements of true phosphorus digestibility estimated by isotope dilution of ^{32}P (Compère, 1967; Grace, 1980; Field *et al.*, 1984; Challa and Braithwaite, 1989) or alternative methods (Aguerre *et al.*, 2002; Bravo *et al.*, 2003), and from indirect calculations using a database of literature results established from around 100 publications. Within a family of feed materials (cereals, oil seed meals), the specific results from each feed material were used when available. When this was not possible, the final value was an average value weighted by the number of results available for each feed material in the family concerned. In all cases we applied a safety margin taking into account the variability of the measurements. These data will soon be completed by digestible phosphorus values for forages in order to make the system fully operational.

References

- Aguerre M. J., Marçot S., Henselmeyer H., Satter L. D., 2002. Availability of phosphorus in dairy feeds. *J. Dairy Sci. suppl.*, 85, Suppl. 1, 187.
- Becker M., Nehring K., 1965. *Handbuch der Futtermittel*. Ed. Verlag Paul Parey, Berlin.
- Bravo D., Bogaert C., Meschy F., Sauvant D., 2003. Phosphorus availability of oilseed meals determined by the apparent faecal digestibility technique. *Anim. Feed Sci. Technol.*, 108, 43-60.
- Challa J., Braithwaite G. D., 1989. Phosphorus and calcium metabolism in growing calves with special emphasis on phosphorus homeostasis. 4. Studies on milk-fed calves given different amounts of dietary phosphorus with a constant intake of calcium. *J. Agric. Sc. (Camb.)*, 113, 285-289.
- Compère R., 1967. Influence de la nature de l'aliment sur le métabolisme phosphoré. In : Duculot, J. (Ed) *L'étude de l'équilibre phosphocalcique du régime basé sur les variations du métabolisme phosphoré*. Les presses agronomiques de Gembloux. 109-113.
- CVB, 2000. Veevoedertabel 2000. *Chemische samenstelling, verteerbaarheid en voederwaarde van voedermiddelen*, Centraal Veevoederbureau, Lelystad, Pays-Bas.
- Field A. C., Wooliams J. A., Dingwall R. A., Munro C. S., 1984. Animal and dietary variation in the absorption and metabolism of phosphorus by sheep. *J. Agric. Sci.*, 103, 283-291.
- Grace N. D. 1980. Effect of increasing phosphorus intake on the phosphorus faecal endogenous loss in sheep. *Proc. N.Z. Soc. Anim. Prod.*, 40, 221-228.
- INRA, 1978. *Alimentation des ruminants*. INRA Editions, Versailles.
- INRA, 1988. *Alimentation des bovins, ovins et caprins*. INRA Editions, Paris, 471 p.

- Nocek J. E., Tamminga S., 1991. Site of digestion of starch in the gastrointestinal tract of dairy cow and its effect on milk yield and composition. *J. Dairy. Sci.*, 74, 3598-3629.
- Offner A., Bach A., Sauvant D., 2003. Quantitative review of in situ starch degradation in the rumen. *Anim. Feed Sci. Technol.*, 106, 81-93.
- Rulquin H., Vérité R., Guinard-Flament J., 2001a. Acides aminés digestibles dans l'intestin. Le système AADI et les recommandations d'apport pour la vache laitière. *Prod. Anim.*, 14, 265-274.
- Rulquin H., Vérité R., Guinard-Flament J., Pisulewski P. M., 2001b. Acides aminés digestibles dans l'intestin. Origine des variations chez les ruminants et répercussion sur les protéines du lait, *Prod. Anim.*, 14, 201-210.
- Sauvant D., 1997, Conséquences digestives et zootechniques des variations de la vitesse de digestion de l'amidon chez les ruminants. *Prod. Anim.*, 10, 287-300.
- Sauvant D., Bas P., 2001. La digestion des lipides chez le ruminant, *Prod. Anim.*, 14, 303-310.
- Sauvant D., Chapoutot P., Archimède H., 1994. La digestion des amidons par les ruminants et ses conséquences. *Prod. Anim.*, 7, 115-124.
- Schiemann R., Nehring K., Hoffman L., Jentsch W., Chudy A., 1971. *Energetische Futterbewertung und Energienormen*, VEB Deutscher Landwirtschaftsverlag, Berlin, 344 p.
- Tamminga S., Van Straalen W. M., Subnel A. P. J., Meijer R. G. M., Steg A., Wever C. J. G., Block M. C., 1994. The Dutch protein evaluation system: the DVE/OEB system. *Livest. Prod. Sci.*, 40, 139-145.
- Vérité R., Michalet-Doreau B., Chapoutot P., Peyraud J. L., Poncet C., 1987. Révision du système des protéines digestibles dans l'intestin (PDI), *Bull. Tech. CRZV, Theix, INRA*. 70, 19-34.
- Vermorel M., Coulon J. B., Journet M. R., 1987. Révision du système des Unités Fourragères (UF), *Bull. Tech. CRZV, INRA*. 70, 9-18.

Nutritional value for rabbits

Jean-Marc Perez

Introduction

The nutritional values published in previous feed tables for rabbits diverge greatly, even for the most common feed materials (NRC, 1977; Cheeke, 1987; INRA, 1989; Maertens *et al.*, 1990; Perez *et al.*, 1998b). Furthermore, the underlying concepts are often different, notably for the estimation of energy values: these values can be calculated through a global approach using efficiencies of energy utilisation, or by a general equation based on digestible nutrients.

The differences between the existing tables essentially arise from long-standing methodological problems in the evaluation of rabbit feeds. In particular, due to the lack of standardisation, each laboratory developed its own methodology. Besides, in the rabbit - as opposed to other monogastrics (pigs and poultry) - it is often necessary to work with complex diets and low substitution rates (due to mandatory fibre requirements). This means that even small inaccuracies in diet measurements can cause very large errors in the estimation of the digestibility coefficients for feed materials (Villamide *et al.*, 1998).

Over the last few years, the measurement methodology of the nutritional value of feedstuffs has been the topic of concerted studies at the European level, with particular emphasis on the standardisation of *in vivo* methods (Perez *et al.*, 1995a) and on the harmonisation of analytical methods for feeds and faeces (EGRAN, 2001). This resulted in the adoption of a European reference method to determine the digestibility of diets (Perez *et al.*, 1995b) and in the harmonisation of the procedures used to calculate the nutritional value of feed materials within mixtures of feedstuffs (Villamide *et al.*, 2001).

Selection of nutritional criteria

Our aim in producing these tables was to provide reliable data, rather than to change the fundamental concepts of rabbit feeding. Therefore, we had to select the most relevant nutritional criteria and discard parameters such as ileal amino acid digestibility or phosphorus availability, which, though interesting, have not yet proven to be suitable in rabbit feeding due the lack of experimental data.

In addition, fibre digestibility (crude fibre and Van Soest cell wall fractions) was not introduced into the tables, because the available experimental data are very imprecise and were judged to be too discordant to be able to produce reliable average values.

For nutritional values, three major criteria were used:

- apparent faecal digestibility of crude protein (Nd)
- digestible energy (DE)
- metabolisable energy (ME).

Since the DE system may lead to an overestimation of the energy value of protein-rich feed materials, it is recommended that formulation of diets should be performed on a ME basis, by taking into account an average estimation of energy losses in urine and fermentation gases.

Because nitrogen (principally in urea form) is a dominant fraction of urinary excretion, the ME value depends both quantitatively and qualitatively on the supply of nitrogen (balance of amino acids). Therefore, to avoid any interference between the expression of energy and nitrogen nutrition, we propose a ME corrected for a zero nitrogen balance (ME_n). Due to the difficulties encountered when making measurements on rabbits, the ME was calculated directly using the DE values given in the tables and a ME/DE coefficient dependent on the characteristics of the feed material. We applied a correction factor based on the ratio DCP/DE (DCP = digestible crude protein) rather than on crude protein. This ratio corresponds to a nitrogen balance relative to energy. Assuming a zero nitrogen balance, 1 g of digestible protein corresponds to a loss of 0.16 g of urinary nitrogen. If we estimate at 30.1 kJ the loss of energy corresponding to 1 g of urinary nitrogen (Jentsch *et al.*, 1963), the correction is 4.81 kJ per g of DCP.

A fixed value of 0.5% of the DE can be used to correct for the losses in gaseous form. A more rigorous approach would be to use a correction factor (yet to be established) based on cell wall content and cell wall digestibility, since the losses of gas depend on these parameters. However, these losses remain low in the rabbit.

We propose the following equation, which estimates ME value from a DE value obtained in animals:

$$\text{ME}_n = \text{DE} \times \text{ME/DE}$$

$$\text{with ME/DE} = 0.995 - 0.00481 \times \text{DCP (in g)} / \text{DE (in MJ)}$$

When formulating feeds, this method of calculation has the advantage of creating a hierarchy between feed materials that represents more accurately the way energy is used by rabbits in balanced diets.

Selection of nutritional data

In the present work, we have tried to be as precise as possible by using literature data first, and then, systematically, our own data. Therefore, the values presented are the product of a inclusive survey of international literature, completed when necessary by as yet unpublished results. The tables of nutritional value of feedstuffs for rabbits resulting from a collaboration between several European researchers (Perez *et al.*, 1998b) were used as the starting point for this update.

We selected the final data after a comprehensive review of the publications and a comparison of all of the experimental results. For some feed materials, the nutritional data appeared to diverge greatly between experiments. In this case, the values were chosen after an in-depth critical analysis of the methods used in each *in vivo* experiment, such as the technique used to measure digestibility, the number of repetitions, the level of inclusion of the feed material in the experimental diets, the calculation procedures, the precision of the estimation etc.

Coherence with the chemical composition

The final average values were chosen after paying particular attention to the consistency between chemical and nutritional parameters. Therefore, for each feed material, the proposed nutritional value was adjusted by taking into account the average chemical composition published in the tables. For feed materials with a large variability, the users can correct the nutritional values through specific equations based on analytical parameters. This was the case of alfalfa using the crude fibre content (CF in % dry matter):

$$\text{Nd (\%)} = 78.7 - 0.69 \text{ CF (Perez, unpublished)} \quad (n = 12; r = -0.8; \text{RSD} = 2.1)$$

$$\text{DE (MJ/kg dry matter)} = 13.94 - 0.196 \text{ CF (Perez et al., 1998a)} \quad (n = 16; r = -0.94; \text{RSD} = 0.30)$$

References

- Cheeke P. R., 1987. *Rabbit feeding and nutrition*. Academic Press Inc., Orlando, USA, 376 p.
- EGRAN (European Group on Rabbit Nutrition: Gidenne T., Perez J. M., Xiccato G., Trocino A., Carabaño R., Villamide M. J., Blas E., Cervera C., Falcao e Cunha L., Maertens L.), 2001. Technical note: attempts to harmonize chemical analyses of feeds and faeces for rabbit feed evaluation. *World Rabbit Sci.*, 9, 57-64.
- INRA, 1989. *L'alimentation des animaux monogastriques : porc, lapin, volailles*. INRA Editions, Paris, 282 p.
- Jentsch W., Schiemann L., Hofmann L., Nehring K., 1963. Die energetische Verwertung der Futterstoffe. 2. Die energetische Verwertung der Kraftfutterstoffe durch Kaninchen. *Arch. Tierernähr.*, 13, 133-145.
- Maertens L., Janssen W. M. M., Steenland E., Wolters D. F., Branje H. E. B., Jager F., 1990. Tables de composition, de digestibilité et de valeur énergétique des matières premières pour lapins. *5èmes Journ. Rech. Cunicole Fr.*, Paris, 12-13/12/1990. Communication n°57. ITAVI Ed., Paris.
- NRC, 1977. *Nutrient requirements of rabbits* (2nd Ed.). Nat. Acad. Sci., Washington, DC, USA, 30 p.
- Perez J. M., Cervera C., Falcao e Cunha L., Maertens L., Villamide M. J., Xiccato G., 1995a. European ring-test on *in vivo* determination of digestibility in rabbits: reproducibility of a reference method in comparison with domestic laboratory procedures. *World Rabbit Sci.*, 3, 171-178.
- Perez J. M., Lebas F., Gidenne T., Maertens L., Xiccato G., Parigi-Bini R., Dalle Zotte A., Cossu M. E., Carazzolo, A., Villamide M. J., Carabaño R., Fraga M. J., Ramos M. A., Cervera C., Blas E., Fernandez J., Falcão e Cunha L., Bengala Freire J., 1995b. European reference method for *in vivo* determination of diet digestibility in rabbits. *World Rabbit Sci.*, 3, 41-43.
- Perez J. M., Lamboley B., Béranger C., 1998a. Valeur nutritive de différentes luzernes déshydratées utilisées seules ou en mélange dans le régime du lapin en croissance. *7èmes Journ. Rech. Cunicole Fr.*, Lyon, 13-14 mai 1998. ITAVI Ed., Paris, 129-132.
- Perez J. M., Maertens L., Villamide M. J., De Blas C., 1998b. Tables de composition et de valeur nutritive des aliments destinés au lapin: conclusions d'un groupe de travail européen. *7èmes Journ. Rech. Cunicole Fr.*, Lyon, 13-14 mai 1998, ITAVI Ed., Paris, 141-146.
- Villamide M. J., Maertens L., De Blas C., Perez J. M., 1998. Feed Evaluation. In: *The Nutrition of the Rabbit*, De Blas C. and Wiseman J. (Eds), Chap. 6, p. 89-101. CABI Publishing, CAB International, Wallingford, UK.
- Villamide M. J., Maertens L., Cervera C., Perez J. M., Xiccato G., 2001. A critical approach of the calculation procedures to be used in digestibility determination of feed ingredients for rabbits. *World Rabbit Sci.*, 9, 19-25.

Nutritional values for horses

William Martin-Rosset

In France, the first specific tables for horses, based on new nutritional concepts (net energy and digestible proteins expressed, respectively in Unités Fourragères Cheval - UFC, Forage units for horses - and in Matières Azotées Digestibles Cheval - MADC, Digestible Crude Protein for Horses), were developed and published by INRA in 1984 ("Le Cheval") and in 1990 ("Alimentation des chevaux"). The present tables are an evolution of these previous works, based on the same concepts but updated with recent data, thus improving the tools and the methods to predict energy and nitrogen values of horse feeds (Martin-Rosset *et al.*, 1996).

Energy values

The energy value of feeds is expressed in UFC. This energy unit corresponds to the net energy value of one kilogramme (as fed) of a reference barley, used for maintenance in the horse (INRA, 1984 and Vermorel and Martin-Rosset, 1997).

Origin of the data and characteristics of the data file

A group of 51 individual results of chemical composition and digestibility of feed materials were used to estimate the energy values. The majority of these data come from work performed in France (INRA), in the Netherlands (PR, Praktijkonderzoek Rundvee, Schapen en Paarden, in collaboration with INRA), in Germany, in the United Kingdom, in Italy and in the United States of America.

The file contains chemical composition data (ash, crude fibre and crude protein) and at least one of the following digestibility parameters: dry matter (DMd), organic matter (OMd) or energy (Ed) digestibility. Omd is essential for the determination of energy values. Although it is measured in most experiments, it was sometimes missing and was estimated by regression from the DMd. In a few rare cases, Omd and Ed were estimated from pig and ruminants values published in the present tables.

Development of equations to predict the energy value of feed materials

The UFC values for 51 feed materials were calculated using the factorial method, also called analytical method, which is distinctive for the net energy system of INRA. The relationships were established by regression between the reference UFC value previously calculated and the chemical composition with or without digestible organic matter (DOM) or digestible energy (DE) used as independent variables. The most precise calculated energy values were of course those including digestible elements in the prediction model (DOM or DE).

These relationships use the following abbreviations: CF (crude fibre), CP (crude protein), CC (cytoplasmic carbohydrates, i.e. starch and sugars), OM (organic matter) and DOM (digestible organic matter), all expressed in % dry matter. DE is the digestible energy expressed in MJ/kg dry matter.

Concentrates (n = 51)

$$\text{UFC} = 0.815 - 0.947 \text{ CF} / 100 + 0.0345 \text{ CP} / 100 + 0.582 \text{ CC} / 100 \quad (r = 0.96; \text{RSD} = 0.06)$$

$$\text{UFC} = 0.131 - 0.628 \text{ CF} / 100 - 0.282 \text{ CP} / 100 + 1.340 \text{ DOM} / 100 \quad (r = 0.98; \text{RSD} = 0.04)$$

$$\text{UFC} = -0.730 - 0.722 \text{ CP} / 100 + 0.572 \text{ OM} / 100 + 0.0941 \text{ DE} \quad (r = 0.99; \text{RSD} = 0.03)$$

$$\text{UFC} = -0.134 + 0.274 \text{ CF} / 100 - 0.362 \text{ CP} / 100 + 0.316 \text{ CC} / 100 + 0.0755 \text{ DE} \\ (r = 0.99; \text{RSD} = 0.02)$$

Forages (n = 47)

$$\text{UFC} = -0.056 + 0.562 \text{ CC} / 100 + 0.0619 \text{ DE} \quad (r = 0.99; \text{RSD} = 0.01)$$

$$\text{UFC} = -0.124 + 0.254 \text{ CC} / 100 + 1.330 \text{ DOM} / 100 \quad (r = 0.99; \text{RSD} = 0.01)$$

Calculation of the energy values of feed materials

Reference method

The energy values of the feed materials were first calculated using the INRA reference method (INRA, 1984; Vermorel and Martin-Rosset, 1997) when the digestibility was known. The digestibility values of 59 feed materials in the tables were derived from the same literature data that had served previously to establish the UFC system and notably the UFC value for concentrates. An additional set of 21 recent values obtained between 1984 and 1990, essentially by INRA, were also used. As it has already been indicated, the digestibility values for a small number of feed materials were taken from the pig or ruminant values presented in this book, when crude fibre and ADF was lower than 15 % dry matter or higher than 15 % dry matter respectively.

Digestible energy

Energy digestibility (Ed) was calculated from OMd using a general equation established in collaboration in 1994 between INRA in France and PR in the Netherlands using a data file of 75 feed materials (concentrates and forages) for which Ed had been measured.

$$\text{Ed} (\%) = 0.034 + \Delta + 0.9477 \text{ OMd} (\%) \quad (r = 0.99; \text{RSD} = 1.1)$$

with $\Delta = +1.1$ for concentrates

$\Delta = -1.1$ for forages

Digestible energy (DE) is calculated from gross energy (GE):

$$\text{DE} = \text{GE} \times \text{Ed} / 100$$

Metabolisable energy

Metabolisable energy (ME) can be predicted from digestible energy using regression equations between the ME/DE ratio and the chemical composition of the feed materials. These equations were established by INRA, using a data file of 79 results.

In the following equations, CF, CP and CC are expressed in % dry matter.

- Feed materials with CP > 30 % on dry matter basis

$$100 \text{ ME/DE} = 94.36 + 0.110 \text{ CF} - 0.275 \text{ CP} \quad (r = 0.41; \text{RSD} = 1.75)$$

- Sugar beet pulp

$$100 \text{ ME/DE} = 89$$

- Other feed materials

$$100 \text{ ME/DE} = 84.07 + 0.165 \text{ CF} - 0.276 \text{ CP} + 0.184 \text{ CC} \quad (r = 0.67; \text{RSD} = 1.37)$$

Calculation of metabolisable energy:

$$\text{ME} = \text{DE} \times 100 \text{ ME/DE}$$

Efficiency of utilisation of metabolisable energy for net energy

The physiological situation used as reference in the UFC system is the maintenance (m). The efficiency of utilisation of ME is expressed by the coefficient km, where $0 < km < 1$.

km can be predicted from the chemical composition of feed materials by taking into account, if necessary, the DOM for 5 groups of feed materials, using the equations established by INRA on a data file of 48 results (Vermorel and Martin-Rosset, 1997).

In the following equations, CP, CF, DOM and CC are expressed in % dry matter.

- Cereals, legume seeds (excluding oil seeds) and molasses

$$100 \text{ km} = 77.45 - 0.060 \text{ CP} + 0.106 \text{ CC} - 0.054 \text{ DOM} \quad (r = 0.99; \text{RSD} = 0.32)$$

- Cereal by-products, corn gluten feed, dehydrated sugar beet pulp, dehydrated potato and soybean hulls

$$100 \text{ km} = 94.41 - 0.237 \text{ OM} - 0.022 \text{ CP} + 0.121 \text{ CC} \quad (r = 0.98; \text{RSD} = 0.45)$$

- Carob

$$100 \text{ km} = 100.32 - 0.194 \text{ OM} - 0.120 \text{ CP} - 0.530 \text{ CF} \quad (r = 0.94; \text{RSD} = 0.76)$$

- Oil seed meals

$$100 \text{ km} = 67.03 + 0.0426 \text{ CP} + 0.1566 \text{ CC} \quad (r = 0.95; \text{RSD} = 0.29)$$

- Dehydrated alfalfa, dehydrated grass, wheat straw

$$100 \text{ km} = 57.56 - 0.110 \text{ CF} + 0.105 \text{ CP} + 0.270 \text{ CC} + 0.150 \text{ DOM}$$

For forages, the following correction ($\Delta \text{ km}$) is applied. It takes into account the extra energy needed for the ingestion of forages (Vermorel and Martin-Rosset, 1997).

$$\Delta \text{ km} = - 0.20 \text{ CF} + 2.50$$

$$\text{km} = \text{km} - \Delta \text{ km}$$

Net energy and UFC

$$\text{NE (MJ/kg)} = \text{ME} \times \text{km}$$

One UFC corresponds to the net energy contained in 1 kg of standard barley (87% dry matter) used for maintenance, or 9.42 MJ/kg: 1UFC = 9.42 MJ NE.

$$\text{UFC} = \text{ME} \times \text{km} / 9.42$$

Estimation of the UFC value using the chemical composition and the digestible components of feed materials

The UFC values of the feed materials were also calculated by using a set of equations previously described (p. 58). These equations take into account the chemical composition and the digestible components of the feed materials.

Calculation of digestible components

The DOM value was calculated from the organic matter and OMD. For the majority of feed materials, the DOM data come from measurements (literature and/or INRA). For dehydrated alfalfa and for dehydrated grass, OMD was predicted from the chemical composition given in the tables and INRA equations linking OMD and the crude fibre content (expressed in % dry matter):

$$\text{Grass: OMD (\%)} = 81.51 - 0.792 \text{ CF} \quad (n = 19; r = 0.42; \text{RSD} = 6.3)$$

$$\text{Alfalfa: OMD (\%)} = 90.52 - 0.995 \text{ CF} \quad (n = 25; r = 0.66; \text{RSD} = 3.7)$$

Digestible energy was calculated as indicated above.

Calculation of UFC values

4 groups of feed materials have been considered.

- Cereal grains, cereal by-products (wheat milling by-products and gluten feed), legume and oil seeds (pea, lupin, faba bean, full fat rapeseed and full fat sunflower seed), oil seed meals (groundnut, rapeseed, linseed, sunflower, copra, sesame and soybean), dehydrated sugar beet pulp, dehydrated potato, carob and molasses.

- Feed materials with a known OMD

$$\text{UFC} = -0.134 + 0.274 \text{ CF} / 100 - 0.362 \text{ CP} / 100 + 0.316 \text{ CC} / 100 + 0.0755 \text{ DE}$$

- Other feed materials (including oil seeds but excluding legume seeds and oil seed meals rich in cell walls)

$$\text{UFC} = 0.815 - 0.947 \text{ CF} / 100 + 0.0345 \text{ CP} / 100 + 0.582 \text{ CC} / 100$$

- Dehydrated alfalfa and dehydrated grass

$$\text{UFC} = -0.056 + 0.562 \text{ CC} / 100 + 0.0619 \text{ DE}$$

- Soybean hulls

$$\text{UFC} = -0.730 - 0.722 \text{ CP} / 100 + 0.572 \text{ OM} / 100 + 0.0941 \text{ DE}$$

- Wheat straw

$$\text{UFC} = -0.124 + 0.254 \text{ CC} / 100 + 1.33 \text{ DOM} / 100$$

Comparison of energy values calculated by the analytical method and directly using prediction equations

The differences between the UFC values calculated either by the analytical method or the prediction equations, for the feed materials for which the digestibility could be accurately estimated, are very low ($-0.04 < \Delta \text{UFC} < +0.02$) and are not significantly related to the chemical composition. They are consistent with those calculated from a separate data file containing 43 feed materials for which both chemical composition and digestibilities were available.

The differences are of the same order of magnitude whether the UFC values were calculated by equations using chemical composition alone or in association with digestible elements such as DOM or DE.

Therefore, the UFC values of 81 feed materials in the tables have been calculated using either of the following methods:

- Equations associating chemical composition criteria with a digestible element, DE, when OMD could be established with adequate precision (59 feed materials)

- Equations based on the chemical composition of feed materials for which DOM or DE could not be established with precision (22 feed materials).

Comparison with other tables

The vectors for the chemical composition of the feed materials and their digestibility values in the present tables were compared with the previous INRA tables (INRA, 1984; INRA, 1990).

The chemical composition and digestibility values sometimes differ significantly for feed materials common to the old and new tables, so that UFC values can be different. In addition, the energy value of the reference barley increased slightly from 9.21 MJ/kg (INRA, 1984) to 9.42 MJ/kg based on the latest INRA research (Vermorel and Martin-Rosset, 1997).

The present tables are more complete (81 feed materials) than the previous INRA tables (33 feed materials). This was made possible by using prediction equations based exclusively on the chemical composition. However, we did not wish to extend this method to all the feed materials in the new tables, since it was important to remain within the validity range of the equations.

The Dutch feed tables (CVB, 2000) use a net energy system that is very similar to the INRA system (Ellis, 2002). The German (DLG, 1995) and North American (NRC, 1989) tables use the digestible energy system. This system overestimates energy values, especially when cell walls and/or crude protein values are high (Martin-Rosset and Vermorel, 2002).

Nitrogen value

Definition and principle

The nitrogen value of feed materials represents the quantity of amino acids from dietary and microbial origin absorbed in the digestive tract. It is expressed in digestible crude protein for the horse, called MADC (INRA, 1984; INRA, 1990; Tisserand and Martin-Rosset, 1996).

The nitrogen value depends on the crude protein content in the feed material, on its digestibility (Nd) and on the proportion of amino acids absorbed in the small and large intestines. It is expressed by a coefficient k that is specific for each group of feed materials:

$$\text{MAD} = \text{CP} \times \text{Nd}$$

$$\text{MADC} = \text{DCP} \times k$$

Digestibility of nitrogen (Nd) in the digestive tract and calculation of digestible crude protein (MAD)

The MAD values were established according to the type of feed material.

In the following equations, MAD is expressed in g/kg dry matter and CP is expressed in % dry matter.

- Cereals

$$\text{MAD} = - 4.94 + 8.533 \text{ CP} \quad (r = 0.93; \text{RSD} = 7.7)$$

- Dehydrated alfalfa

$$\text{MAD} = - 29.95 + 8.673 \text{ CP} \quad (r = 0.93; \text{RSD} = 9.2)$$

- Dehydrated grass

$$\text{MAD} = - 25.96 + 8.357 \text{ CP} \quad (r = 0.97; \text{RSD} = 7.1)$$

- Other feed materials

For the other feed materials, the MAD values were established either by *in vivo* measurements taken from the literature and/or from INRA, or, in a very limited number of cases, from the pig or ruminant values presented in this book, when crude fibre and ADF was lower than 15 % dry matter or higher than 15 % dry matter respectively.

Calculation of the MADC value of feed materials

The coefficient k depends on the type of feed material.

- $k = 1$ for concentrates

$$\text{MADC} = \text{MAD}$$

- $k = 0.85$ for dehydrated forages

$$\text{MADC} = \text{MAD} \times 0.85$$

- $k = 0.80$ for straw and by-products rich in lignin

$$\text{MADC} = \text{MAD} \times 0.80$$

The k values depend, firstly, on the true digestibility of crude protein in the small and large intestines and, secondly, on the recovery of amino acids of microbial and dietary origin absorbed in the large intestine. The true digestibility values were validated with INRA results using the mobile nylon bag technique (in the small and large intestines) on 37 feed materials (21 forages and 16 concentrates; Macheboeuf *et al.*, 1995; Martin-Rosset and Tisserand, 2002) and in the USA by ileal flow markers (Coleman *et al.*, 2000)

Comparison with other tables

The values of total crude protein, of nitrogen digestibility and MADC published in the tables were compared with those of previous INRA tables.

The MADC values are slightly different due to the changes in crude protein content. The precision of estimations of total and partial digestibility in the small intestine vs. large intestine respectively has been improved due to the new data, obtained mainly in France (INRA), the Netherlands (PR) and the USA. The tables are also more complete.

The Dutch (CVB, 2000) and German (DLG, 1995) tables express the nitrogen value in MAD. In the North American tables, the nitrogen value is expressed as crude protein. The MAD and CP systems overestimate the nitrogen value of feed materials, notably for forages, and to a lesser extent for concentrates, when the levels of NDF and above all ligno-cellulose (ADF) are high (Marin-Rosset and Tisserand, 2002).

References

- Coleman R. J., Mathison G. W., Hardin R. T., Milligan J. P., 2000. Effect of dietary forage and protein concentration on total tract, prececal and post-ileal protein and lysine digestibilities of forage based diets fed to mature ponies. In: *17th ENPS Symposium*, May 31st-June 2nd 2000, Lexington KY, United States, p. 461-463.
- CVB, 2000. Veevoedertabel 2000. *Chemische samenstelling, verteerbaarheid en voederwaarde van voedermiddelen*. Centraal Veevoederbureau, Lelystad, The Netherlands.
- DLG, 1995. *DLG-Futtertabellen - Pferde*. DLG-Verlag, Germany. 96 p.
- Ellis A., 2002. The Dutch modification of the French system (Net Energy). In: *1st European Workshop on Equine Nutrition*. Dijon. January 17-18th, France. p. 59-67
- INRA, 1984. *Le Cheval. Reproduction, sélection, alimentation, exploitation*. Jarrige R. and Martin-Rosset W. Eds. INRA Editions, Paris, 689 p.
- INRA, 1990. *Alimentation des chevaux*. Martin-Rosset W. Ed., INRA Editions, Paris, 232 p.
- Macheboeuf D., Marangi M., Poncet, C., Martin-Rosset W., 1995. Study of nitrogen digestion from different hays by the mobile nylon bag technique in horses. *Ann. Zootech.*, 44 Suppl. 219 (abstract).
- Martin-Rosset W., Andrieu J., Vermorel M., Dulphy J. P., 1984. Valeur nutritive des aliments pour le cheval. 208-238. In: *Le Cheval. Reproduction, sélection, alimentation, exploitation*. Jarrige R. and Martin-Rosset W. Eds. INRA Editions, Paris, 689 p.
- Martin-Rosset W., Vermorel M., Doreau M., Tisserand J. L., Andrieu J., 1994. The French horse feed evaluation systems and recommended allowances for energy and protein. *Livest. Prod. Sci.*, 40, 37-56.
- Martin-Rosset W., Andrieu J., Vermorel M., 1996. Routine methods for predicting the net energy value (UFC) of feeds in horses. In: *Proceedings of the 47th EAAP Meeting*, Lillehammer, Norway, August 26-29. Horse Commission. Session IV. Abstract H 4.1 p. 292. Wageningen Pers. Ed. Wageningen, The Netherlands. Full paper 14 p.
- Martin-Rosset W., Vermorel M., 2002. Evaluation and expression of energy allowances and energy value of feeds in the UFC system for the performance horse. In: *1st European Workshop on Equine Nutrition*. Dijon. January 17-18th, France. p. 19- 58
- Martin-Rosset W., Tisserand J. L., 2002. Evaluation and expression of protein allowances and protein value of feeds in the MADC system for the performance horse. In: *1st European Workshop on Equine Nutrition*. January 17-18th, Dijon, France. p. 109-148.
- NRC, 1989. *Nutrient requirements of horses*. 5th Revised Edition. National Academy Press, Washington, DC., 100p.
- Tisserand J. L., Martin-Rosset W., 1996. Evaluation of the protein value of feedstuffs in horses in the MADC system. In: *Proceedings of the 47th Annual Meeting of European Association for Animal Production*. Lillehammer, Norway, August 26-29. Horse Commission. Session IV. Abstract H 4.3 p. 293. Wageningen Pers. Ed. Wageningen, The Netherlands. Full paper 13 p.

Vermorel M., Martin-Rosset W., 1997. Concepts, scientific bases, structure and validation of the French horse net energy system (UFC). *Livest. Prod. Sci.*, 47, 261-275.

Nutritional values for fish

Sadasivam J. Kaushik

Introduction

Aquaculture is an expanding sector, with an annual growth rate of around 8-10 % in terms of world tonnage. It already supplies more than 25% of all aquatic products. Numerous forms of aquaculture coexist. While carp (70 % of fresh water aquaculture) and prawns (a brackish water production) are both farmed in ponds where natural feeding is still dominant, the production of salmonids and other marine fish is based exclusively on the use of compound feeds.

In developed countries, as well as in many developing ones, intensive fish farming dependent on industrial feeds is becoming increasingly important. This evolution requires scientific and technical data ever more precise and diversified. Another aspect of aquaculture concerns the large number of fish species farmed, as more than 200 species are currently raised worldwide.

Several books on fish nutrition and feeding have been published recently (Guillaume *et al.*, 1999; Halver and Hardy, 2002). Scientific data on the nutritional requirements of several species of economic interest are also available (Wilson, 1991; Webster and Lim, 2001). It should be noted that data are more abundant for major fish families such as cyprinids and salmonids than for other species. Initially, the nutritional recommendations were proposed separately for cold water species and tropical species (NRC, 1981 and 1983). As recent scientific advances have shown that there were indeed many similarities between species, the last published results (NRC, 1993) grouped together the data for all fish species.

In a previous INRA book (Guillaume *et al.*, 1999), we have already described the practical aspects of fish feeding, such as the choice of feed materials and the manufacture of diets for aquatic animals. This book also contains feed tables for diet formulation.

Since aquaculture is an integral part of animal production, it was logical to include data concerning fish in the present tables. However, due to the specificities of fish nutrition (high protein requirements, specific requirements for n-3 fatty acids, low availability of carbohydrates and dietary fibre), the formulation of fish feeds is based on a relatively small number of raw materials. Therefore, we have supplied information for feed materials that are currently used in aquaculture.

Selection and production of data

We have used data from experimental works carried out with tried and tested methodologies. In fish studies, the collection of faeces is an important issue as the leaching of faecal material may lead to an overestimation of the digestibility. Currently, only two reliable methods exist to collect fish faeces. The first one is based on rapid decantation (Cho and Slinger, 1978) while the second, developed by INRA, is more effective since it allows the continuous collection of faeces (Choubert *et al.*, 1982). The INRA system is illustrated in the figure below.

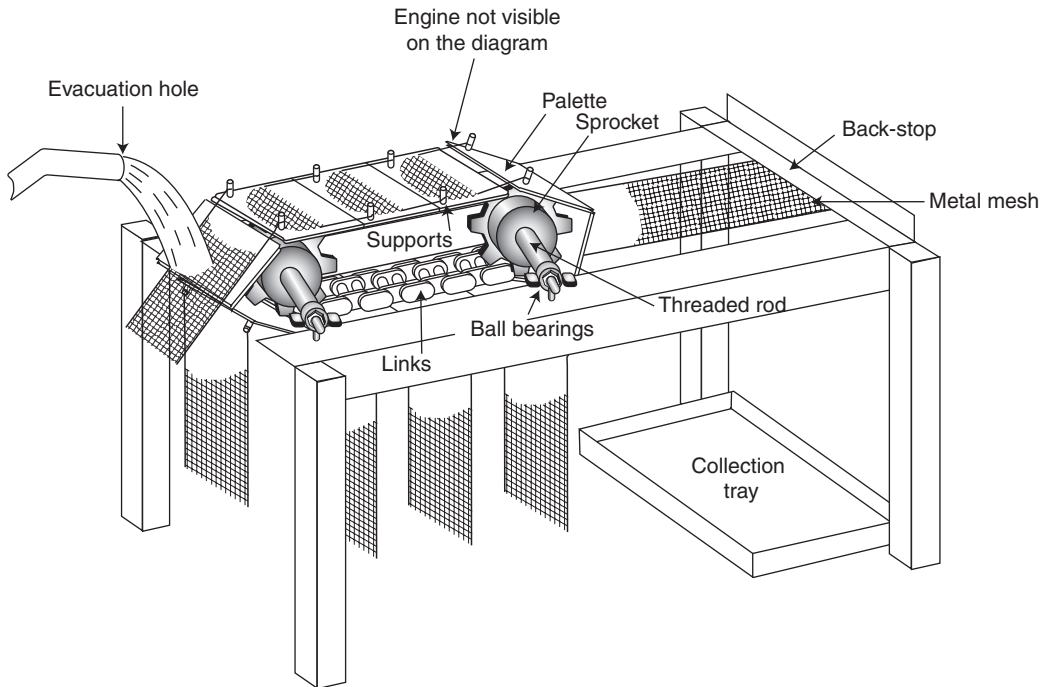

Figure 8. Machine for the continuous collection of faeces by filtration (developed by INRA).

Since the total collection of faeces corresponding to a given meal is difficult in aquatic animals, apparent digestibilities are measured indirectly by incorporating an inert marker, usually chromic oxide, into the feed. Recently, other markers such as acid-insoluble ash, crude fibre, polyethylene, alkanes, cholestane or rare earth metals have been used successfully.

Digestibility of feed materials is measured by difference. The feed material is incorporated - generally at 30% - into a basal diet of known digestibility. The estimation of protein digestibility by *in vitro* methods, which is used for terrestrial animals, has not been successful in fish since the values obtained are very variable. Another method to estimate protein digestibility in fish, used a few years ago in Norway, was based on the measurement of digestibility in the mink, a carnivorous animal. As it was shown that there was a good correlation between the *in vivo* digestibility of fish meal proteins in mink and in salmonids, several authors have used this indirect technique. However, such a relationship underestimates the digestibility values in fish, especially for feed materials with very high protein digestibilities, such as fish soluble protein concentrates.

There are few data on the digestibility of amino acids in fish. In general, the digestibility of crude protein reflects quite accurately that of amino acids. Due to the fact that the measurement of metabolisable energy is difficult and also of little benefit in fish nutrition (Cho and Kaushik, 1990), we have chosen to use digestible energy data.

Due to the importance of the farming of salmonids in Europe, we have chosen to provide data concerning this family (rainbow trout, Atlantic salmon and Pacific salmon). It is important to

indicate that the data available for the other species such as carp, tilapia and sea bass (da Silva and Oliva-Teles, 1988; INRA, unpublished) or gilthead sea bream (Nengas *et al.*, 1995; INRA, unpublished) are quite similar for the same feed materials, though there are differences in the digestibility of plant carbohydrates (Bergot, 1993) and phosphorus between fish with or without a stomach (NRC, 1993). Although a fish species can be reared at different temperatures, the available data do not show a significant effect of temperature on feed material digestibilities, except for carbohydrates. In addition, since feed technology plays an important role in aquaculture (Kaushik, 2001), we have only presented values for raw feed materials, without taking into consideration the processes involved in feed manufacturing.

References

- Bergot F., 1993. Digestibility of native starches of various botanical origins by rainbow trout (*Oncorhynchus mykiss*). In: Kaushik S. J., Luquet P., *Fish Nutrition in Practice*, IVth Int. Symp. Fish Nutrition and Feeding, "Les colloques", 61, INRA Editions, Paris, 857-865.
- Cho C. Y., Kaushik S. J., 1990. Nutritional energetics in fish: energy and protein utilization in rainbow trout (*Salmo gairdneri*). *World Rev. Nutr. Diet.*, 61, 132-172.
- Cho C. Y., Slinger S. J., 1979. Apparent digestibility measurement in feedstuffs for rainbow trout. In: Tiews K., J.E. Halver J. E., *World Symposium on Finfish Nutrition and Fishfeed Technology*, EIFAC-FAO, Rome, Italy, vol 2: 239-247.
- Choubert G., de la Noue J., Luquet P., 1982. Digestibility in fish: improved device for the automatic collection of faeces. *Aquaculture*, 29, 185-189.
- da Silva J.G., Oliva-Teles A., 1998. Apparent digestibility coefficients of feedstuffs in seabass (*Dicentrarchus labrax*) juveniles. *Aquat. Living Resour.*, 11, 187-191.
- Guillaume J., Kaushik S., Bergot P., Métailler R., 1999. Nutrition et alimentation des poissons et crustacés. INRA Editions - IFREMER, Paris, 489 p.
- Halver J.E., Hardy R.W. (Eds), 2002. *Fish Nutrition*, Third Edition. Academic Press, San Diego, USA.
- Kaushik S. J., 2001. Feed technologies and nutrient availability in Aquatic feeds. In: *Advances in Nutritional Technology*, Proc. 1st World Feed Conf, Utrecht., van der Poel A. F. B., Vahl J. L. and Kwakkel R. P. (Eds), p. 187-196.
- Nengas I., Alexis M. N., Davies S. J., Petichakis G., 1995. Investigation to determine digestibility coefficients of various raw materials in diets for gilthead sea bream, *Sparus aurata* L. *Aquacult. Res.*, 26, 185-194.
- NRC, 1981. *Nutrient requirements of coldwater fishes*. National Academy of Sciences, Washington D.C., USA, 63 p.
- NRC, 1983. *Nutrient requirements of warmwater fishes and shellfishes*. National Academy of Sciences, Washington D.C., USA, 102 p.
- NRC, 1993. *Nutrient requirements of fish*. National Academy of Sciences, Washington D.C., USA, 114 p.
- Webster C.D., Lim C.E., 2001. *Nutrient requirements and Feeding of Aquaculture Fish*. CABI Publications, UK.
- Wilson R. P., 1991. *Handbook of nutrient requirements of finfish*. CRC Press, USA, 196 p.

Biological values of mineral sources

François Meschy

Diets are often deficient in minerals compared to animal requirements. They must be corrected either by incorporating a premix in the diet (monogastrics), or by the distribution of a mineral feed (ruminants).

The choice of mineral sources - minerals or organo-metallic complexes - is therefore a very important one: efficient mineral utilisation by the animal is necessary both to satisfy its mineral requirements and to limit pollution from farm effluents (mainly phosphorus, copper and zinc). Up until now, except for the book *Bioavailability of nutrients for animals* (Ammermann *et al.*, 1995), there was practically no literature review on the subject. Taking into account this situation and the importance of the question, the International Association of the European Manufacturers of Major, Trace and Specific Feed Mineral Materials (EMFEMA) commissioned in 1999 a European group of experts (G. De Groote and M. Lippens, Belgium, for poultry; A. Jongbloed, The Netherlands, for pigs and F. Meschy, France, for ruminants) to produce an up to date report on the subject (EMFEMA, 2002).

We are indebted to EMFEMA for having let us use large extracts from this report.

Choosing a scale of relative biological value (RBV) has allowed the integration of experimental data in addition to those on apparent and true absorption (for example, bone parameters and tissue concentrations). Publications were only included in the database if they satisfied certain conditions. Notably, the mineral source studied needed to be precisely (and if possible chemically) defined and the experimental and analytical methods had to be clearly described. The results from a total of 222 publications, irrespective of type of mineral and animal species, were used to create the database. Weighting factors were applied to take into account the pertinence and the reliability of the parameters studied. This scale could be modified depending on whether the dietary supply covered animal requirements or whether it was above requirements. In the case of measurements of tissue concentrations, \log_{10} transformation of the values was performed for some elements (copper, zinc and selenium) to keep the RBV within physiological limits. In order to take into account the power of the experimental setups, the average values were weighted by the square root of the number of trials in the same publication. The tables indicate, for each species and for each mineral element, the number of trials, the average value and the standard deviation.

In most cases, the reference source (RBV = 100) is unique, thus enabling direct comparisons of mineral sources. The tables present only the most frequently used mineral sources in Europe. Additional information and the detailed protocol of this study are provided in the original document published by the EMFEMA (downloadable from www.emfema.org).

References

- Ammerman C. B., Baker D. H., Lewis A. J., 1995. *Bioavailability of nutrients for animals: amino acids, minerals, and vitamins*. Academic Press, San Diego, CA.
- EMFEMA, 2002. *Bioavailability of major and trace minerals*. EMFEMA, Brussels.

Abbreviations

The following abbreviations are used in the text and tables.

The units indicated are those used in the tables.

- In the text, the data are on a dry matter basis (when applicable).
- In the tables, the data are on an as fed basis (when applicable).

Abbreviation	Description and units
a	Immediately degradable fraction, in % (kinetic parameter of nitrogen, starch or dry matter degradation in ruminants)
AA	Amino acid content, in g/kg and in % of crude protein (or conventionally in g per 16 g of nitrogen)
AADI	Amino acid digestible in the intestine (ruminants), in % PDIE
ADF	Acid Detergent Fibre, in %
ADL	Acid Detergent Lignin, in %
AID	Apparent ileal digestibility of an individual amino acid for pigs, in %
AIDC	Digestible amino acid content corresponding to the apparent ileal digestibility for pigs, in g/kg. In the tables, this value corresponds to the corrected AIDC (equation 3 in the chapter “Nutritional values for pigs”, page 32).
AMEn	Apparent metabolisable energy corrected for zero nitrogen balance, in MJ/kg
Ash	Mineral matter, in %
b	Potentially degradable fraction, in % (kinetic parameter of nitrogen, starch and dry matter degradation in ruminants)
c	Hourly rate of particle degradation, in % x h ⁻¹ (kinetic parameter of nitrogen, starch and dry matter degradation in ruminants)
CC	Cytoplasmic carbohydrates (starch and sugars), in %
CF	Crude fibre, in %
CP	Crude protein, in %

DCAD	Dietary cation-anion difference, in mEQ/kg
DE	Digestible energy, in MJ/kg
DEE	Digestible ether extract, in %
DM	Dry matter, in %
DOM	Digestible organic matter, in %
Dry matter ED	Dry matter effective degradability in ruminants, in %
EB	Electrolyte balance, in mEq/kg
Ed	Energy digestibility, in %
EE	Ether extract, in %
EEd	Ether extract digestibility, in %
FAd	Fatty acid digestibility, in %
Fatty acids	Fatty acids are expressed in % of an individual fatty acid relative to the total fatty acids and in g/kg
Fatty acids / ether extract	% of total fatty acids in the ether extract. This coefficient can be used to calculate an individual fatty acid content from the percentage of this fatty acid relative to the total fatty acids.
FOM	Fermentable organic matter in the rumen, in g/kg
GE	Gross energy, in MJ/kg
MAD	Digestible crude protein, in g/kg
MADC	Digestible crude protein in the horse, in g/kg
ME	Metabolisable energy, in MJ/kg
ME _n	Metabolisable energy corrected for zero nitrogen balance, in MJ/kg
n	Maximum number of samples retained for each profile. It often corresponds to the number of protein values used in the calculations.
Nd	Nitrogen digestibility, in %

NDF	Neutral Detergent Fibre, in %
NE	Net energy, in MJ/kg
NED or Nitrogen ED	Effective degradability of nitrogen in ruminants, in %
NSId	Standardised ileal digestibility of nitrogen in pigs, in %
OM	Organic matter, in %
OMd	Organic matter digestibility, in %
P availability	Phosphorus availability in poultry, expressed in % of the phosphorus used by the animal compared to a source of phosphorus supposed to be available.
Pd	Phosphorus digestibility, in %. In pigs, it corresponds to the digestibility observed when there is no endogenous phytase (naturally absent or inactivated by technological treatment)
P _{Phy} d	Phosphorus digestibility in the pig, when endogenous phytase has not been inactivated, in %
PDIA	Digestible proteins in the intestine of dietary origin, in g/kg
PDIE	Digestible proteins in the intestine where energy is the limiting factor for rumen microbial activity, in g/kg
PDIN	Digestible proteins in the intestine where nitrogen is the limiting factor for rumen microbial activity, in g/kg
Phytate P/ Total P	Phytate phosphorus as a % of total phosphorus
RSD	Residual standard deviation
sd	Standard deviation
SID	Standardised ileal digestibility of an amino acid for pigs, in %
SIDC	Digestible amino acid content corresponding to the standardised ileal digestibility for pigs, in g/kg
Starch ED	Starch effective degradability in ruminants, in %
TD	True digestibility of an amino acid in poultry, in %

TDC	Digestible amino acid content corresponding to the true digestibility for poultry, in g/kg
TId	True intestinal digestibility of non-degraded dietary proteins in ruminants, in %
UDCP	Non-digestible (undigested) crude protein, in %
UDOM	Non-digestible (undigested) organic matter, in %
UFC	Forage unit for horses (Unité Fourragère Cheval), per kg
UFL	Forage unit for milk production (Unité Fourragère Lait), per kg
UFV	Forage unit for meat production (Unité Fourragère Viande), per kg

Tables of composition and nutritional value

Cereals

Wheat by-products

Maize by-products

Other cereal by-products

Legume and oil seeds

Oil seed meals

Starch, roots and tubers

Other by-products of plant origin

Dehydrated forages

Milk products

Fish meals and solubles

Other animal by-products

Processed feed materials: nutritional values for ruminants

Fats

Synthetic amino acids

Mineral sources

Barley

Barley grain (*Hordeum* spp.), including 2-row and 6-row varieties (n = 2739).

Toasted barley for ruminants: see page 291

All values are expressed on an as fed basis unless otherwise noted.

Main constituents	mean	sd	Fatty acids	%FA	g/kg
Dry matter (%)	86.7	1.2	Myristic acid C14:0	1.2	0.2
Crude protein (%)	10.1	0.9	Palmitic acid C16:0	22.2	3.0
Crude fibre (%)	4.6	0.7	Stearic acid C18:0	1.5	0.2
Ether extract (%)	1.8	0.2	Oleic acid C18:1	12.0	1.6
Ash (%)	2.2	0.2	Linoleic acid C18:2	55.4	7.5
Insoluble ash (%)	0.5	0.1	Linolenic acid C18:3	5.6	0.8
Neutral detergent fibre (%)	18.7	3.2	Fatty acids/ether extract (%)	75	
Acid detergent fibre (%)	5.5	0.9			
Acid detergent lignin (%)	1.0	0.3			
Water insoluble cell walls (%)	14.9	1.4			
Starch (%)	52.2	2.3			
Total sugars (%)	2.1	0.7			
Gross energy (MJ/kg)	15.9	0.3			

Mineral elements	mean	sd	Vitamins	mean
Calcium (g/kg)	0.7	0.4	Vitamin A (1000 UI/kg)	2.22
Phosphorus (g/kg)	3.4	0.3	Vitamin E (mg/kg)	16
Phytate P / total P (%)	55		Vitamin B1 - thiamin (mg/kg)	4
Magnesium (g/kg)	1.1	0.2	Vitamin B2 - riboflavin (mg/kg)	1.5
Potassium (g/kg)	4.8	0.7	Vitamin B6 - pyridoxine (mg/kg)	4
Sodium (g/kg)	0.1	0.1	Vitamin B12 (µg/kg)	0
Chlorine (g/kg)	1.1	0.3	Niacin (mg/kg)	53
Sulphur (mg/kg)	1.3		Pantothenic acid (mg/kg)	7
DCAD (mEq/kg)	19		Folic acid (mg/kg)	0.35
EB (mEq/kg)	98		Biotin (mg/kg)	0.14
Manganese (mg/kg)	16	4	Choline (%)	1008
Zinc (mg/kg)	30	8		
Copper (mg/kg)	9	5		
Iron (mg/kg)	158	136		
Selenium (mg/kg)	0.11			
Cobalt (mg/kg)	0.13			
Molybdenum (mg/kg)	0.44			
Iodine (mg/kg)	0.09			
			Other	mean
			Real applied viscosity (ml/g)	4.2
			Phytase activity (UI/kg)	540

Pigs	Growing	Sow	Poultry	Cockerel	Broiler
DE (MJ/kg)	12.8	13.2	AMEn (MJ/kg)	11.5	10.9
ME (MJ/kg)	12.4	12.7	P availability (%)		59
NE (MJ/kg)	9.5	9.7	Horses		
Ed (%)	81	83	UFC (per kg)	0.99	
OMd (%)	84	85	MADC (g/kg)	82	
Nd (%)	75	80	Rabbits		
NSId (%)		80	DE (MJ/kg)	12.7	
EEEd (%)		28	MEEn (MJ/kg)	12.3	
Pd (%)		32	Ed (%)	80	
P _{Phy} d (%)		41	Nd (%)	67	
Ruminants			Fish		
UFL (per kg)		0.95	DE (MJ/kg)		
UFV (per kg)		0.93	Ed (%)		
PDIA (g/kg)		30	Nd (%)		
PDIN (g/kg)		69			
PDIE (g/kg)		87			
ME (kcal/kg)		10.7			
Ed (%)		81			
OMd (%)		83			
Nd (%)		66			
TId (%)		91			
FAd (%)		66			
Absorbed phosphorus (g/kg)		2.6			
<i>Ruminal degradation</i>	<i>Nitrogen</i>	<i>Starch</i>	<i>DM</i>		
Effective degradability	71	89	75		
a (%)	29	52	44		
b (%)	65	48	45		
c (%/h)	11.0	20.5	13.5		

Amino acid content and digestibility

Amino acids	Total		Pigs				Poultry		Ruminants
	g/kg	% CP	AID	AIDC	SID	SIDC	TD	TDC	AADI % PDIE
LYS	3.8	3.8	68	2.6	75	2.8	78	3.0	6.8
THR	3.5	3.4	67	2.3	75	2.6	76	2.6	5.0
MET	1.7	1.7	79	1.4	84	1.4	80	1.4	1.9
CYS	2.3	2.3	79	1.8	84	2.0	83	1.9	
MET+CYS	4.1	4.0	79	3.2	84	3.4	82	3.3	
TRP	1.3	1.2	72	0.9	79	1.0			
ILE	3.6	3.6	75	2.7	81	2.9	80	2.9	5.2
VAL	5.2	5.1	74	3.8	80	4.1	80	4.1	5.8
LEU	6.9	6.8	78	5.3	83	5.7	83	5.7	8.1
PHE	4.9	4.9	79	3.9	84	4.1	84	4.2	5.1
TYR	2.8	2.8	77	2.2	83	2.4	81	2.3	
PHE+TYR	7.8	7.7	78	6.1	83	6.5	83	6.4	
HIS	2.2	2.2	76	1.7	81	1.8	84	1.9	2.0
ARG	4.8	4.8	78	3.8	83	4.0	83	4.0	4.7
ALA	4.1	4.1	63	2.6	71	2.9	73	3.0	
ASP	6.0	5.9	68	4.1	76	4.5	75	4.5	
GLU	23.1	22.9	86	19.8	88	20.4	89	20.6	
GLY	4.0	4.0	66	2.7	76	3.1	88	3.6	
SER	4.2	4.2	75	3.2	81	3.4	78	3.3	
PRO	10.9	10.8	79	8.6	84	9.2	87	9.5	

Maize

Maize grain (*Zea mays* L.) (n = 2634).

Synonym (North America): corn.

Expanded maize, extruded maize, flaked maize, high moisture maize, pelleted maize and toasted maize for ruminants: see page 291

All values are expressed on an as fed basis unless otherwise noted.

Main constituents	mean	sd	Fatty acids	%FA	g/kg
Dry matter (%)	86.4	1.1	Myristic acid C14:0	0.1	0.0
Crude protein (%)	8.1	0.7	Palmitic acid C16:0	11.1	3.5
Crude fibre (%)	2.2	0.4	Palmitoleic acid C16:1	0.4	0.1
Ether extract (%)	3.7	0.4	Stearic acid C18:0	1.8	0.6
Ash (%)	1.2	0.1	Oleic acid C18:1	26.9	8.5
Insoluble ash (%)	0.0	0.1	Linoleic acid C18:2	56.5	17.8
Neutral detergent fibre (%)	10.4	1.5	Linolenic acid C18:3	1.0	0.3
Acid detergent fibre (%)	2.6	0.4			
Acid detergent lignin (%)	0.5	0.2	Fatty acids/ether extract (%)	85	
Water insoluble cell walls (%)	9.1	2.7			
Starch (%)	64.1	1.9			
Total sugars (%)	1.6	0.5			
Gross energy (MJ/kg)	16.2	0.3			

Mineral elements	mean	sd	Vitamins	mean
Calcium (g/kg)	0.4	0.3	Vitamin A (1000 UI/kg)	2.32
Phosphorus (g/kg)	2.6	0.3	Vitamin E (mg/kg)	17
Phytate P / total P (%)	75		Vitamin K (mg/kg)	0.31
Magnesium (g/kg)	1.0	0.2	Vitamin B1 - thiamin (mg/kg)	4
Potassium (g/kg)	3.2	0.4	Vitamin B2 - riboflavin (mg/kg)	1.4
Sodium (g/kg)	0.04	0.03	Vitamin B6 - pyridoxine (mg/kg)	5
Chlorine (g/kg)	0.5	0.2	Vitamin B12 (µg/kg)	0
Sulphur (mg/kg)	1.1		Niacin (mg/kg)	21
DCAD (mEq/kg)	0.38		Pantothenic acid (mg/kg)	6
EB (mEq/kg)	68		Folic acid (mg/kg)	0.25
Manganese (mg/kg)	8	7	Biotin (mg/kg)	0.06
Zinc (mg/kg)	19	6	Choline (%)	533
Copper (mg/kg)	2	1.0		
Iron (mg/kg)	32	11		
Selenium (mg/kg)	0.10			
Cobalt (mg/kg)	0.05			
Molybdenum (mg/kg)	0.41			
Iodine (mg/kg)	0.09			

Other	mean
Real applied viscosity (ml/g)	0.6
Xanthophylls (mg/kg)	24
Phytase activity (UI/kg)	20

Pigs	Growing	Sow	Poultry	Cockerel	Broiler
DE (MJ/kg)	14.2	14.8	AMEn (MJ/kg)	13.4	13.1
ME (MJ/kg)	13.9	14.4	P availability (%)		24
NE (MJ/kg)	11.1	11.4	Horses		
Ed (%)	88	91	UFC (per kg)	1.12	
OMd (%)	91	94	MADC (g/kg)	65	
Nd (%)	81	91	Rabbits		
NSId (%)		86	DE (MJ/kg)	12.8	
EEEd (%)		60	MEEn (MJ/kg)	12.6	
Pd (%)		28	Ed (%)	80	
Ruminants			Nd (%)	65	
UFL (per kg)		1.06	Fish		
UFV (per kg)		1.06	DE (MJ/kg)	6.3	
PDIA (g/kg)		46	Ed (%)	39	
PDIN (g/kg)		64	Nd (%)	95	
PDIE (g/kg)		84			
ME (kcal/kg)		11.7			
Ed (%)		86			
OMd (%)		89			
Nd (%)		66			
TId (%)		90			
FAd (%)		74			
Absorbed phosphorus (g/kg)		1.9			
<i>Ruminal degradation</i>	<i>Nitrogen</i>	<i>Starch</i>	<i>DM</i>		
Effective degradability	43	60	56		
a (%)	11	23	20		
b (%)	82	77	76		
c (%/h)	4.0	5.5	5.5		

Amino acid content and digestibility

Amino acids	Total		Pigs				Poultry		Ruminants
	g/kg	% CP	AID	AIDC	SID	SIDC	TD	TDC	AADI
			%	g/kg	%	g/kg	%	g/kg	% PDIE
LYS	2.4	3.0	70	1.7	80	1.9	85	2.1	5.7
THR	3.0	3.7	74	2.2	83	2.5	88	2.7	4.8
MET	1.7	2.1	87	1.5	91	1.5	94	1.6	1.9
CYS	2.0	2.5	82	1.7	89	1.8	93	1.9	
MET+CYS	3.7	4.6	85	3.1	90	3.3	93	3.5	
TRP	0.5	0.6	65	0.3	80	0.4			
ILE	3.0	3.7	82	2.5	88	2.7	92	2.8	4.9
VAL	4.1	5.0	81	3.3	87	3.6	92	3.8	5.5
LEU	10.2	12.5	90	9.2	93	9.5	96	9.8	10.2
PHE	4.0	4.9	87	3.5	91	3.7	94	3.8	5.0
TYR	3.4	4.2	85	2.9	90	3.1	94	3.2	
PHE+TYR	7.4	9.1	86	6.4	91	6.8	94	7.0	
HIS	2.4	2.9	84	2.0	89	2.1	90	2.1	2.3
ARG	3.8	4.7	85	3.2	91	3.5	95	3.6	4.6
ALA	6.1	7.5	84	5.2	89	5.5	94	5.8	
ASP	5.3	6.5	79	4.2	87	4.6	90	4.8	
GLU	15.4	18.9	89	13.7	93	14.3	96	14.8	
GLY	3.1	3.8	69	2.1	82	2.5	89	2.7	
SER	4.1	5.0	83	3.4	89	3.6	93	3.8	
PRO	7.5	9.2	82	6.2	89	6.7	96	7.2	

Oats

Oat grain (*Avena sativa* L.) (n = 1132).

Flaked and toasted oats for ruminants: see page 291

All values are expressed on an as fed basis unless otherwise noted.

Main constituents	mean	sd	Fatty acids	%FA	g/kg
Dry matter (%)	88.1	1.7	Myristic acid C14:0	0.2	0.1
Crude protein (%)	9.8	1.3	Palmitic acid C16:0	16.6	7.1
Crude fibre (%)	12.2	1.9	Palmitoleic acid C16:1	0.2	0.1
Ether extract (%)	4.8	0.9	Stearic acid C18:0	1.2	0.5
Ash (%)	2.7	0.4	Oleic acid C18:1	37.1	15.9
Insoluble ash (%)	0.8	0.4	Linoleic acid C18:2	37.5	16.1
Neutral detergent fibre (%)	32.8	5.0	Linolenic acid C18:3	1.5	0.6
Acid detergent fibre (%)	14.9	2.2	Fatty acids/ether extract (%)	90	
Acid detergent lignin (%)	2.5	0.9			
Water insoluble cell walls (%)	32.7	4.3			
Starch (%)	36.2	4.3			
Total sugars (%)	1.1	0.4			
Gross energy (MJ/kg)	17.2	0.4			

Mineral elements	mean	sd	Vitamins	mean
Calcium (g/kg)	1.1	0.4	Vitamin A (1000 UI/kg)	2.03
Phosphorus (g/kg)	3.2	0.4	Vitamin E (mg/kg)	12
Phytate P / total P (%)	55		Vitamin K (mg/kg)	0.51
Magnesium (g/kg)	1.0	0.1	Vitamin B1 - thiamin (mg/kg)	6
Potassium (g/kg)	4.6	0.8	Vitamin B2 - riboflavin (mg/kg)	1.6
Sodium (g/kg)	0.1	0.1	Vitamin B6 - pyridoxine (mg/kg)	5
Chlorine (g/kg)	1.0		Vitamin B12 (µg/kg)	0
Sulphur (mg/kg)	1.8		Niacin (mg/kg)	17
DCAD (mEq/kg)	-19		Pantothenic acid (mg/kg)	8
EB (mEq/kg)	94		Folic acid (mg/kg)	0.33
Manganese (mg/kg)	40	13	Biotin (mg/kg)	0.20
Zinc (mg/kg)	23	4	Choline (%)	981
Copper (mg/kg)	3	1.0		
Iron (mg/kg)	106	54		
Selenium (mg/kg)	0.19			
Cobalt (mg/kg)	0.09			
Molybdenum (mg/kg)	0.83			
Iodine (mg/kg)	0.10			
			Other	mean
			Real applied viscosity (ml/g)	4.2
			Phytase activity (UI/kg)	40

Pigs	Growing	Sow	Poultry	Cockerel	Broiler
DE (MJ/kg)	11.0	11.7	AMEn (MJ/kg)	9.8	9.3
ME (MJ/kg)	10.6	11.1	P availability (%)		24
NE (MJ/kg)	8.0	8.3	Horses		
Ed (%)	64	68	UFC (per kg)	0.87	
OMd (%)	68	72	MADC (g/kg)	79	
Nd (%)	75	85	Rabbits		
NSId (%)		76	DE (MJ/kg)	10.9	
EEEd (%)		55	MEEn (MJ/kg)	10.5	
Pd (%)		32	Ed (%)	63	
Ruminants			Nd (%)	73	
UFL (per kg)		0.77	Fish		
UFV (per kg)		0.71	DE (MJ/kg)		
PDIA (g/kg)		16	Ed (%)		
PDIN (g/kg)		61	Nd (%)		
PDIE (g/kg)		61			
ME (kcal/kg)		9.2			
Ed (%)		65			
OMd (%)		67			
Nd (%)		55			
TId (%)		79			
FAd (%)		75			
Absorbed phosphorus (g/kg)		2.4			
<i>Ruminal degradation</i>	<i>Nitrogen</i>	<i>Starch</i>	<i>DM</i>		
Effective degradability	81	93	62		
a (%)	63	67	50		
b (%)	29	33	26		
c (%/h)	10.0	21.5	5.0		

Amino acid content and digestibility

Amino acids	Total		Pigs				Poultry		Ruminants
	g/kg	% CP	AID	AIDC	SID	SIDC	TD	TDC	AADI % PDIE
LYS	4.1	4.2	67	2.8	73	3.0	86	3.5	7.0
THR	3.4	3.5	61	2.1	69	2.4	80	2.8	5.1
MET	1.8	1.8	80	1.4	84	1.5	88	1.5	2.0
CYS	3.2	3.3	71	2.3	75	2.4	84	2.7	
MET+CYS	5.0	5.1	75	3.7	78	3.9	85	4.3	
TRP	1.2	1.3	72	0.9	78	1.0			
ILE	3.7	3.8	74	2.7	79	2.9	87	3.2	5.3
VAL	5.2	5.3	72	3.7	77	4.0	85	4.4	5.8
LEU	7.2	7.4	77	5.5	81	5.8	87	6.3	8.2
PHE	4.9	5.0	80	3.9	84	4.1	90	4.4	5.2
TYR	3.5	3.6	74	2.6	80	2.8	86	3.0	
PHE+TYR	8.4	8.6	78	6.5	82	6.9	88	7.4	
HIS	2.1	2.1	79	1.6	83	1.7	91	1.9	2.0
ARG	6.6	6.7	84	5.6	88	5.8	91	6.0	4.9
ALA	4.7	4.8	63	2.9	69	3.2	83	3.9	
ASP	8.5	8.7	71	6.0	76	6.4	86	7.3	
GLU	16.8	17.2	84	14.1	86	14.5	93	15.6	
GLY	5.0	5.1	61	3.0	70	3.4			
SER	4.8	4.9	69	3.3	74	3.6	82	3.9	
PRO	6.0	6.2	63	3.8	72	4.4	90	5.4	

Oat groats

Oat grain (*Avena sativa* L.) from which the hulls have been removed (n = 51).

Synonym: dehulled oats, shelled oats.

All values are expressed on an as fed basis unless otherwise noted.

Main constituents	mean	sd	Fatty acids	%FA	g/kg
Dry matter (%)	85.6	1.0	Myristic acid C14:0	0.2	0.0
Crude protein (%)	10.6	1.3	Palmitic acid C16:0	16.6	3.7
Crude fibre (%)	4.0	1.0	Palmitoleic acid C16:1	0.2	0.0
Ether extract (%)	2.5	1.9	Stearic acid C18:0	1.2	0.3
Ash (%)	2.1	0.2	Oleic acid C18:1	37.1	8.4
Neutral detergent fibre (%)	11.6		Linoleic acid C18:2	37.5	8.5
Acid detergent fibre (%)	4.6		Linolenic acid C18:3	1.5	0.3
Acid detergent lignin (%)	1.7				
Water insoluble cell walls (%)	15.3		Fatty acids/ether extract (%)	90	
Starch (%)	52.6	1.6			
Total sugars (%)	1.2				
Gross energy (MJ/kg)	16.1				

Mineral elements	mean	sd	Vitamins	mean
Calcium (g/kg)	0.9		Vitamin E (mg/kg)	13
Phosphorus (g/kg)	2.9		Vitamin B1 - thiamin (mg/kg)	5
Phytate P / total P (%)	55		Vitamin B2 - riboflavin (mg/kg)	2
Magnesium (g/kg)	0.9		Folic acid (mg/kg)	1.0
Potassium (g/kg)	3.6		Biotin (mg/kg)	0.81
Sodium (g/kg)	0.1		Choline (%)	570
Chlorine (g/kg)	0.7			
Sulphur (mg/kg)	1.3			
DCAD (mEq/kg)	-6			
EB (mEq/kg)	78			
Manganese (mg/kg)	32			
Zinc (mg/kg)	26			
Copper (mg/kg)	3			
Selenium (mg/kg)	0.09			
Cobalt (mg/kg)	0.01			
Molybdenum (mg/kg)	0.19			
			Other	mean
			Phytase activity (U/kg)	36

Pigs	Growing	Sow	Poultry	Cockerel	Broiler
DE (MJ/kg)	13.4	13.7	AMEn (MJ/kg)	11.6	
ME (MJ/kg)	13.0	13.2	P availability (%)	21	
NE (MJ/kg)	10.0	10.1			
Ed (%)	84	85	Horses		
OMd (%)	86	88	UFC (per kg)	0.98	
Nd (%)	80	84	MADC (g/kg)	86	
NSId (%)		79			
EEEd (%)		49	Rabbits		
Pd (%)		32	DE (MJ/kg)		
			MEEn (MJ/kg)		
Ruminants			Ed (%)		
UFL (per kg)		0.97	Nd (%)		
UFV (per kg)		0.96			
PDIA (g/kg)		19	Fish		
PDIN (g/kg)		67	DE (MJ/kg)		
PDIE (g/kg)		77	Ed (%)		
ME (kcal/kg)		11.0	Nd (%)		
Ed (%)		82			
OMd (%)		84			
Nd (%)		68			
TId (%)		85			
FAd (%)		71			
Absorbed phosphorus (g/kg)		2.1			
Ruminal degradation	Nitrogen	Starch	DM		
Effective degradability	81	93	80		
a (%)					
b (%)					
c (%/h)					

Amino acid content and digestibility

Amino acids	Total		Pigs				Poultry		Ruminants
	g/kg	% CP	AID	AIDC	SID	SIDC	TD	TDC	AADI
			%	g/kg	%	g/kg	%	g/kg	% PDIE
LYS	4.4	4.2	75	3.3	79	3.5			7.1
THR	3.7	3.5	76	2.8	80	3.0			5.1
MET	1.9	1.8	83	1.6	85	1.6			2.0
CYS	3.4	3.2	83	2.8	85	2.9			
MET+CYS	5.2	4.9	83	4.3	85	4.4			
TRP	1.3	1.3	78	1.0	82	1.1			
ILE	4.0	3.8	80	3.2	83	3.3			5.3
VAL	5.6	5.3	78	4.4	81	4.6			5.8
LEU	7.8	7.4	80	6.3	83	6.5			8.2
PHE	5.4	5.1	81	4.4	83	4.5			5.2
TYR	3.8	3.6	81	3.1	85	3.2			
PHE+TYR	9.2	8.6	81	7.5	84	7.7			
HIS	2.3	2.1	80	1.8	83	1.9			2.0
ARG	7.3	6.8	84	6.1	86	6.3			4.9
ALA	5.0	4.7	73	3.7	77	3.8			
ASP	9.2	8.7	80	7.4	83	7.6			
GLU	18.7	17.6	86	16.0	87	16.3			
GLY	5.3	5.0	75	4.0	80	4.3			
SER	5.2	4.9	82	4.3	85	4.4			
PRO	6.6	6.2							

Rice, brown

Whole unpolished rice grain (*Oryza sativa* L.) with only the husk removed (n = 17).

Synonym: whole rice, rice groats.

All values are expressed on an as fed basis unless otherwise noted.

Main constituents	mean	sd	Fatty acids	%FA	g/kg
Dry matter (%)	87.4	1.5	Lauric acid C12:0	0.1	0.0
Crude protein (%)	8.0	1.3	Myristic acid C14:0	0.7	0.1
Crude fibre (%)	0.5	0.3	Palmitic acid C16:0	18.1	1.9
Ether extract (%)	1.2	0.9	Palmitoleic acid C16:1	0.3	0.0
Ash (%)	1.0	0.3	Stearic acid C18:0	1.9	0.2
Neutral detergent fibre (%)	0.8		Oleic acid C18:1	40.2	4.2
Acid detergent fibre (%)	0.6		Linoleic acid C18:2	35.9	3.8
Acid detergent lignin (%)	0.0		Linolenic acid C18:3	1.5	0.2
Starch (%)	75.9	3.3	Arachidic acid C20:0	0.2	0.0
Total sugars (%)	1.3				
Gross energy (MJ/kg)	15.7		Fatty acids/ether extract (%)	90	

Mineral elements	mean	sd	Vitamins	mean
Calcium (g/kg)	0.1		Vitamin E (mg/kg)	9
Phosphorus (g/kg)	2.0		Vitamin B1 - thiamin (mg/kg)	5
Phytate P / total P (%)	80		Vitamin B2 - riboflavin (mg/kg)	2
Magnesium (g/kg)	1.4		Vitamin B6 - pyridoxine (mg/kg)	4
Potassium (g/kg)	14.9		Vitamin B12 (µg/kg)	0
Sodium (g/kg)	0.2		Niacin (mg/kg)	50
Chlorine (g/kg)	0.1		Pantothenic acid (mg/kg)	16
Sulphur (mg/kg)	0.9		Folic acid (mg/kg)	0.28
DCAD (mEq/kg)	328		Biotin (mg/kg)	0.12
EB (mEq/kg)	388		Vitamin C (mg/kg)	0
Manganese (mg/kg)	25			
Zinc (mg/kg)	17			
Copper (mg/kg)	2			
Iron (mg/kg)	16			
Selenium (mg/kg)	0.19			
Cobalt (mg/kg)	2			
Molybdenum (mg/kg)	0.75			
Iodine (mg/kg)	0.02			

Pigs	Growing	Sow	Poultry	Cockerel	Broiler
DE (MJ/kg)	15.4	15.4	AMEn (MJ/kg)	14.6	14.4
ME (MJ/kg)	15.0	15.0	P availability (%)		
NE (MJ/kg)	12.0	12.0			
Ed (%)	98	98	Horses		
OMd (%)	98	98	UFC (per kg)	1.16	
Nd (%)	90	91	MADC (g/kg)	65	
EEd (%)		28			
Pd (%)		12	Rabbits		
			DE (MJ/kg)		
Ruminants			MEEn (MJ/kg)		
UFL (per kg)		1.08	Ed (%)		
UFV (per kg)		1.10	Nd (%)		
PDIA (g/kg)		23			
PDIN (g/kg)		55	Fish		
PDIE (g/kg)		66	DE (MJ/kg)		
ME (kcal/kg)		11.8	Ed (%)		
Ed (%)		89	Nd (%)		
OMd (%)		92			
Nd (%)		69			
TId (%)		90			
FAd (%)		62			
Absorbed phosphorus (g/kg)		1.5			
<i>Ruminal degradation</i>	<i>Nitrogen</i>	<i>Starch</i>	<i>DM</i>		
Effective degradability	71	67	70		
a (%)	45	26			
b (%)	40	74			
c (%/h)	11.0	7.5			

Amino acid content and digestibility

Amino acids	Total		Pigs				Poultry		Ruminants
	g/kg	% CP	AID %	AIDC g/kg	SID %	SIDC g/kg	TD %	TDC g/kg	AADI % PDIE
LYS	3.0	3.7					87	2.6	6.7
THR	2.8	3.4					84	2.3	5.0
MET	1.9	2.3							2.1
CYS	1.9	2.4							
MET+CYS	3.8	4.7							
TRP	0.9	1.1							
ILE	3.2	4.0					86	2.8	5.3
VAL	4.7	5.9					86	4.1	5.9
LEU	6.3	7.9					88	5.5	8.3
PHE	4.1	5.1					86	3.5	5.2
TYR	3.7	4.6							
PHE+TYR	7.8	9.7							
HIS	1.9	2.3					94	1.8	2.1
ARG	6.6	8.2					92	6.1	5.2
ALA	4.3	5.3							
ASP	6.9	8.6							
GLU	13.4	16.7							
GLY	3.6	4.4							
SER	4.0	4.9							
PRO	3.4	4.3							

Rye

Rye grain (*Secale cereale* L.) (n = 284).

All values are expressed on an as fed basis unless otherwise noted.

Main constituents	mean	sd	Fatty acids	%FA	g/kg
Dry matter (%)	87.3	1.5	Myristic acid C14:0	0.3	0.0
Crude protein (%)	9.0	1.3	Palmitic acid C16:0	16.6	1.5
Crude fibre (%)	1.9	0.3	Palmitoleic acid C16:1	1.7	0.2
Ether extract (%)	1.2	0.3	Stearic acid C18:0	1.0	0.1
Ash (%)	1.8	0.3	Oleic acid C18:1	18.7	1.7
Neutral detergent fibre (%)	14.1	5.2	Linoleic acid C18:2	52.3	4.8
Acid detergent fibre (%)	3.1	0.6	Linolenic acid C18:3	6.1	0.6
Acid detergent lignin (%)	0.9	0.2			
Water insoluble cell walls (%)	11.7		Fatty acids/ether extract (%)	75	
Starch (%)	53.8	2.5			
Total sugars (%)	3.2	1.1			
Gross energy (MJ/kg)	15.7	0.3			

Mineral elements	mean	sd	Vitamins	mean
Calcium (g/kg)	1.0	0.8	Vitamin E (mg/kg)	15
Phosphorus (g/kg)	3.0	0.3	Vitamin B1 - thiamin (mg/kg)	4
Phytate P / total P (%)	65		Vitamin B2 - riboflavin (mg/kg)	1.7
Magnesium (g/kg)	1.1		Vitamin B6 - pyridoxine (mg/kg)	2
Potassium (g/kg)	4.5		Vitamin B12 (µg/kg)	0
Sodium (g/kg)	0.03		Niacin (mg/kg)	19
Chlorine (g/kg)	0.6		Pantothenic acid (mg/kg)	12
Sulphur (mg/kg)	1.3		Folic acid (mg/kg)	1.0
DCAD (mEq/kg)	22		Biotin (mg/kg)	0.06
EB (mEq/kg)	101		Choline (%)	415
Manganese (mg/kg)	46			
Zinc (mg/kg)	22			
Copper (mg/kg)	5			
Iron (mg/kg)	57			
Selenium (mg/kg)	0.07			
Cobalt (mg/kg)	0.03			
Molybdenum (mg/kg)	0.55			
Iodine (mg/kg)	0.08			
			Other	mean
			Real applied viscosity (ml/g)	21.0
			Phytase activity (UI/kg)	5350

Pigs	Growing	Sow	Poultry	Cockerel	Broiler
DE (MJ/kg)	13.1	13.5	AMEn (MJ/kg)	11.5	9.8
ME (MJ/kg)	12.8	13.0	P availability (%)		47
NE (MJ/kg)	9.9	10.0	Horses		
Ed (%)	84	86	UFC (per kg)	1.05	
OMd (%)	87	89	MADC (g/kg)	63	
Nd (%)	71	76	Rabbits		
NSId (%)		77	DE (MJ/kg)		
EEEd (%)		10	MEEn (MJ/kg)		
Pd (%)		30	Ed (%)		
Pphyd (%)		50	Nd (%)		
Ruminants			Fish		
UFL (per kg)		1.03	DE (MJ/kg)		
UFV (per kg)		1.03	Ed (%)		
PDIA (g/kg)		20	Nd (%)		
PDIN (g/kg)		59			
PDIE (g/kg)		85			
ME (kcal/kg)		11.4			
Ed (%)		86			
OMd (%)		89			
Nd (%)		69			
TId (%)		88			
FAd (%)		59			
Absorbed phosphorus (g/kg)		2.3			
<i>Ruminal degradation</i>	<i>Nitrogen</i>	<i>Starch</i>	<i>DM</i>		
Effective degradability	77	96	80		
a (%)	27		51		
b (%)	69		41		
c (%/h)	16.0		15.0		

Amino acid content and digestibility

Amino acids	Total		Pigs				Poultry		Ruminants
	g/kg	% CP	AID	AIDC	SID	SIDC	TD	TDC	AADI
			%	g/kg	%	g/kg	%	g/kg	% PDIE
LYS	3.5	3.9	65	2.3	72	2.5			7.1
THR	3.1	3.4	62	1.9	71	2.2			5.1
MET	1.4	1.6	76	1.1	81	1.2			2.0
CYS	2.0	2.3	79	1.6	84	1.7			
MET+CYS	3.5	3.9	78	2.7	83	2.9			
TRP	0.9	0.9	68	0.6	76	0.6			
ILE	3.1	3.4	70	2.2	77	2.4			5.3
VAL	4.3	4.8	68	3.0	75	3.3			5.8
LEU	5.4	6.0	72	3.9	78	4.3			8.0
PHE	4.0	4.4	77	3.1	82	3.3			5.0
TYR	2.3	2.5	68	1.6	77	1.8			
PHE+TYR	6.3	7.0	74	4.6	80	5.1			
HIS	1.9	2.1	74	1.4	79	1.5			2.0
ARG	4.5	5.0	75	3.4	80	3.6			4.7
ALA	3.9	4.4	61	2.4	69	2.7			
ASP	6.9	7.7	70	4.9	77	5.3			
GLU	20.8	23.1	86	17.8	89	18.4			
GLY	4.0	4.4	61	2.4	72	2.9			
SER	4.0	4.4	71	2.8	78	3.1			
PRO	9.1	10.1	84	7.6	90	8.2			

Sorghum

Sorghum grain (*Sorghum bicolor* (L.) Moench). The nutritional values for monogastric animals correspond to low-tannin varieties (n = 790).

All values are expressed on an as fed basis unless otherwise noted.

Main constituents	mean	sd	Fatty acids	%FA	g/kg
Dry matter (%)	86.5	1.6	Myristic acid C14:0	0.2	0.1
Crude protein (%)	9.4	1.1	Palmitic acid C16:0	13.5	3.5
Crude fibre (%)	2.4	0.5	Palmitoleic acid C16:1	3.2	0.8
Ether extract (%)	2.9	0.4	Stearic acid C18:0	2.3	0.6
Ash (%)	1.4	0.2	Oleic acid C18:1	33.3	8.7
Insoluble ash (%)	0.1	0.1	Linoleic acid C18:2	33.8	8.9
Neutral detergent fibre (%)	9.4	1.8	Linolenic acid C18:3	2.6	0.7
Acid detergent fibre (%)	3.8	1.3			
Acid detergent lignin (%)	1.1	0.8	Fatty acids/ether extract (%)	90	
Water insoluble cell walls (%)	8.5	0.8			
Starch (%)	64.1	2.6			
Total sugars (%)	1.1	0.4			
Gross energy (MJ/kg)	16.3	0.4			

Mineral elements	mean	sd	Vitamins	mean
Calcium (g/kg)	0.3	0.2	Vitamin A (1000 UI/kg)	0.11
Phosphorus (g/kg)	2.8	0.4	Vitamin E (mg/kg)	10
Phytate P / total P (%)	70		Vitamin B1 - thiamin (mg/kg)	4
Magnesium (g/kg)	1.2	0.2	Vitamin B2 - riboflavin (mg/kg)	1.3
Potassium (g/kg)	3.6	0.4	Vitamin B6 - pyridoxine (mg/kg)	5
Sodium (g/kg)	0.2	0.1	Vitamin B12 (µg/kg)	0
Chlorine (g/kg)	0.6	0.2	Niacin (mg/kg)	37
Sulphur (mg/kg)	0.9		Pantothenic acid (mg/kg)	12
DCAD (mEq/kg)	32		Folic acid (mg/kg)	0.19
EB (mEq/kg)	86		Biotin (mg/kg)	0.23
Manganese (mg/kg)	9	6	Choline (%)	627
Zinc (mg/kg)	19	7		
Copper (mg/kg)	4	2		
Iron (mg/kg)	58	58		
Selenium (mg/kg)	0.43			
Cobalt (mg/kg)	0.23			
Molybdenum (mg/kg)	1.0			
Iodine (mg/kg)	0.02			

Other	mean
Real applied viscosity (ml/g)	0.3
Phytase activity (UI/kg)	30

Pigs	Growing	Sow	Poultry	Cockerel	Broiler
DE (MJ/kg)	14.2	14.5	AMEn (MJ/kg)	13.8	13.5
ME (MJ/kg)	13.9	14.1	P availability (%)		23
NE (MJ/kg)	11.0	11.1	Horses		
Ed (%)	87	89	UFC (per kg)	1.07	
OMd (%)	90	91	MADC (g/kg)	76	
Nd (%)	75	79	Rabbits		
NSId (%)		79	DE (MJ/kg)		
EEEd (%)		55	MEEn (MJ/kg)		
Pd (%)		25	Ed (%)		
			Nd (%)		
Ruminants			Fish		
UFL (per kg)		1.05	DE (MJ/kg)		
UFV (per kg)		1.06	Ed (%)		
PDIA (g/kg)		50	Nd (%)		
PDIN (g/kg)		67			
PDIE (g/kg)		87			
ME (kcal/kg)		11.7			
Ed (%)		86			
OMd (%)		88			
Nd (%)		69			
TId (%)		78			
FAd (%)		72			
Absorbed phosphorus (g/kg)		2.1			
<i>Ruminal degradation</i>	<i>Nitrogen</i>	<i>Starch</i>	<i>DM</i>		
Effective degradability	39	60	67		
a (%)	5	28	36		
b (%)	73	72	59		
c (%/h)	5.5	5.0	6.5		

Amino acid content and digestibility

Amino acids	Total		Pigs				Poultry		Ruminants
	g/kg	% CP	AID	AIDC	SID	SIDC	TD	TDC	AADI % PDIE
LYS	2.2	2.3	63	1.4	74	1.6	87	1.9	5.4
THR	3.1	3.3	67	2.1	76	2.3	89	2.7	4.7
MET	1.5	1.6	81	1.2	85	1.3	90	1.4	1.8
CYS	1.8	1.9	71	1.3	77	1.4	87	1.5	
MET+CYS	3.3	3.5	76	2.5	81	2.7	88	2.9	
TRP	1.0	1.0	71	0.7	79	0.8			
ILE	4.0	4.2	78	3.1	83	3.3	93	3.7	5.1
VAL	5.1	5.4	75	3.8	81	4.1	90	4.6	5.7
LEU	12.8	13.6	84	10.7	86	11.1	95	12.2	11.0
PHE	5.0	5.3	81	4.1	85	4.3	97	4.9	5.3
TYR	3.8	4.1	80	3.1	85	3.3	94	3.6	
PHE+TYR	8.9	9.4	81	7.2	85	7.6	96	8.5	
HIS	2.1	2.2	73	1.5	78	1.6	90	1.9	2.1
ARG	3.8	4.0	75	2.9	82	3.1	95	3.6	4.5
ALA	8.7	9.3	77	6.7	81	7.0	95	8.3	
ASP	1.8	2.0	75	1.4	82	1.5	90	1.7	
GLU	19.7	21.0	83	16.5	86	17.0	96	18.9	
GLY	2.9	3.1	53	1.5	66	1.9			
SER	4.3	4.6	75	3.3	81	3.5	93	4.0	
PRO	8.0	8.5	44	3.5	50	4.0	96	7.7	

Triticale

Triticale grain (*Triticum* × *Secale*) (n = 873).

All values are expressed on an as fed basis unless otherwise noted.

Main constituents	mean	sd	Fatty acids	%FA	g/kg
Dry matter (%)	87.3	1.3	Myristic acid C14:0	1.2	0.1
Crude protein (%)	9.6	0.9	Palmitic acid C16:0	11.3	1.1
Crude fibre (%)	2.3	0.3	Stearic acid C18:0	0.8	0.1
Ether extract (%)	1.4	0.3	Oleic acid C18:1	7.4	0.7
Ash (%)	1.9	0.2	Linoleic acid C18:2	41.9	4.2
Insoluble ash (%)	0.0		Linolenic acid C18:3	3.6	0.4
Neutral detergent fibre (%)	12.7	1.8	Fatty acids/ether extract (%)	75	
Acid detergent fibre (%)	3.2	0.5			
Acid detergent lignin (%)	1.0	0.3			
Water insoluble cell walls (%)	10.6	1.4			
Starch (%)	59.9	2.3			
Total sugars (%)	2.7	0.6			
Gross energy (MJ/kg)	15.7	0.3			

Mineral elements	mean	sd	Vitamins	mean
Calcium (g/kg)	0.7	0.4	Vitamin E (mg/kg)	1.6
Phosphorus (g/kg)	3.5	0.4	Vitamin B1 - thiamin (mg/kg)	3
Phytate P / total P (%)	65		Vitamin B2 - riboflavin (mg/kg)	1.6
Magnesium (g/kg)	1.0	0.3	Niacin (mg/kg)	18
Potassium (g/kg)	4.9	0.8	Pantothenic acid (mg/kg)	6
Sodium (g/kg)	0.1	0.1	Folic acid (mg/kg)	0.15
Chlorine (g/kg)	0.9	0.3	Choline (%)	448
Sulphur (mg/kg)	1.3			
DCAD (mEq/kg)	25			
EB (mEq/kg)	105			
Manganese (mg/kg)	20	15		
Zinc (mg/kg)	20	9		
Copper (mg/kg)	6	3		
Iron (mg/kg)	58			
Molybdenum (mg/kg)	0.44			
Iodine (mg/kg)	0.09			

Other	mean
Real applied viscosity (ml/g)	2.5
Phytase activity (UI/kg)	770

Pigs		Growing	Sow	Poultry		Cockerel	Broiler
DE (MJ/kg)		13.6	13.8	AMEn (MJ/kg)		12.4	11.9
ME (MJ/kg)		13.2	13.4	P availability (%)			66
NE (MJ/kg)		10.3	10.5	Horses			
Ed (%)		86	88	UFC (per kg)		1.06	
OMd (%)		89	90	MADC (g/kg)		78	
Nd (%)		84	88	Rabbits			
NSId (%)			87	DE (MJ/kg)		12.8	
EEd (%)			18	MEEn (MJ/kg)		12.4	
Pd (%)			30	Ed (%)		81	
P _{Phy} d (%)			48	Nd (%)		75	
Ruminants				Fish			
UFL (per kg)			1.01	DE (MJ/kg)		9.5	
UFV (per kg)			1.02	Ed (%)		60	
PDIA (g/kg)			20	Nd (%)		80	
PDIN (g/kg)			63	Pd (%)			
PDIE (g/kg)			84				
ME (kcal/kg)			11.3				
Ed (%)			85				
OMd (%)			88				
Nd (%)			69				
TId (%)			90				
FAd (%)			61				
Absorbed phosphorus (g/kg)			2.6				
<i>Ruminal degradation</i>	<i>Nitrogen</i>	<i>Starch</i>	<i>DM</i>				
Effective degradability	79	95	77				
a (%)	34	45	46				
b (%)	56	55	47				
c (%/h)	23.0	58.5	12.0				

Amino acid content and digestibility

Amino acids	Total		Pigs				Poultry		Ruminants
	g/kg	% CP	AID	AIDC	SID	SIDC	TD	TDC	AADI
			%	g/kg	%	g/kg	%	g/kg	% PDIE
LYS	3.9	4.0	77	3.0	83	3.2	85	3.3	7.1
THR	3.3	3.4	75	2.4	82	2.7	89	2.9	5.1
MET	1.7	1.8	87	1.5	90	1.5	89	1.5	2.0
CYS	2.6	2.7	87	2.2	91	2.3	82	2.1	
MET+CYS	4.3	4.4	87	3.7	91	3.9	85	3.6	
TRP	1.2	1.3	81	1.0	88	1.1			
ILE	3.7	3.8	82	3.0	87	3.2	91	3.3	5.3
VAL	4.7	4.9	80	3.8	86	4.0	85	4.0	5.8
LEU	6.2	6.4	84	5.2	88	5.4	94	5.8	8.0
PHE	4.1	4.3	86	3.6	90	3.7	95	3.9	5.0
TYR	3.0	3.1	84	2.5	90	2.7	90	2.7	
PHE+TYR	7.1	7.4	85	6.1	90	6.4	93	6.6	
HIS	2.3	2.4	86	2.0	89	2.0	91	2.1	2.0
ARG	5.2	5.4	87	4.5	91	4.7	86	4.5	4.7
ALA	4.2	4.3	74	3.1	80	3.3			
ASP	6.5	6.7	79	5.1	85	5.5			
GLU	22.6	23.5	93	20.9	95	21.4			
GLY	4.3	4.4	76	3.2	85	3.6			
SER	4.4	4.5	83	3.6	88	3.8	88	3.8	
PRO	8.2	8.6	87	7.2	94	7.8			

Wheat, durum

Durum wheat grain (*Triticum durum* L.). Durum wheat is normally used to make pasta and semolina (n = 99).

All values are expressed on an as fed basis unless otherwise noted.

Main constituents	mean	sd	Fatty acids	%FA	g/kg
Dry matter (%)	87.6	1.5	Fatty acids/ether extract (%)	75	
Crude protein (%)	14.5	1.3			
Crude fibre (%)	2.7				
Ether extract (%)	1.8				
Ash (%)	1.9				
Neutral detergent fibre (%)	14.4				
Acid detergent fibre (%)	3.7				
Acid detergent lignin (%)	1.1				
Water insoluble cell walls (%)	10.2				
Starch (%)	55.5	3.1			
Total sugars (%)	2.7	0.8			
Gross energy (MJ/kg)	16.2				

Mineral elements	mean	sd
Calcium (g/kg)	0.8	0.3
Phosphorus (g/kg)	3.4	0.5
Magnesium (g/kg)	1.1	
Potassium (g/kg)	4.6	
Sodium (g/kg)	0.1	
Chlorine (g/kg)	1.3	
Sulphur (mg/kg)	1.7	
DCAD (mEq/kg)	-20	
EB (mEq/kg)	86	
Manganese (mg/kg)	50	
Zinc (mg/kg)	15	
Copper (mg/kg)	7	
Iron (mg/kg)	70	
Selenium (mg/kg)	0.06	

Pigs			Growing	Sow	Poultry		Cockerel	Broiler
DE (MJ/kg)			13.9	14.2	AMEn (MJ/kg)			
ME (MJ/kg)			13.4	13.6	P availability (%)			
NE (MJ/kg)			10.3	10.4	Horses			
Ed (%)			85	87	UFC (per kg)		1.06	
OMd (%)			88	90	MADC (g/kg)		117	
Nd (%)			82	85	Rabbits			
EEd (%)				33	DE (MJ/kg)			
Ruminants					MEEn (MJ/kg)			
UFL (per kg)				1.02	Ed (%)			
UFV (per kg)				1.02	Nd (%)			
PDIA (g/kg)				35	Fish			
PDIN (g/kg)				96	DE (MJ/kg)			
PDIE (g/kg)				96	Ed (%)			
ME (kcal/kg)				11.4	Nd (%)			
Ed (%)				85				
OMd (%)				87				
Nd (%)				73				
TId (%)				90				
FAd (%)				66				
Ruminal degradation			<i>Nitrogen</i>	<i>Starch</i>	<i>DM</i>			
Effective degradability			76	94	80			
a (%)								
b (%)								
c (%/h)								

Amino acid content and digestibility

Amino acids	Total		Pigs				Poultry		Ruminants
	g/kg	% CP	AID %	AIDC g/kg	SID %	SIDC g/kg	TD %	TDC g/kg	AADI % PDIE
LYS	3.8	2.6							6.3
THR	4.3	2.9							4.9
MET	2.3	1.6							1.9
CYS	3.4	2.3							
MET+CYS	5.6	3.9							
TRP	1.6	1.1							
ILE	5.2	3.6							5.1
VAL	6.2	4.3							5.5
LEU	9.8	6.8							8.0
PHE	7.1	4.9							5.1
TYR	4.6	3.2							
PHE+TYR	11.7	8.1							
HIS	3.3	2.2							2.0
ARG	7.0	4.8							4.6
ALA	5.0	3.4							
ASP	7.2	5.0							
GLU	44.7	30.9							
GLY	5.7	4.0							
SER	7.3	5.0							
PRO	15.3	10.6							

Wheat, soft

Soft wheat grain (*Triticum aestivum* L.) (n = 7068).

High moisture wheat and toasted wheat for ruminants: see page 291

All values are expressed on an as fed basis unless otherwise noted.

Main constituents	mean	sd	Fatty acids	%FA	g/kg
Dry matter (%)	86.8	1.1	Myristic acid C14:0	0.1	0.0
Crude protein (%)	10.5	0.9	Palmitic acid C16:0	17.8	2.0
Crude fibre (%)	2.2	0.3	Palmitoleic acid C16:1	0.4	0.0
Ether extract (%)	1.5	0.2	Stearic acid C18:0	0.8	0.1
Ash (%)	1.6	0.2	Oleic acid C18:1	15.2	1.7
Insoluble ash (%)	0.1		Linoleic acid C18:2	56.4	6.3
Neutral detergent fibre (%)	12.4	1.7	Linolenic acid C18:3	5.9	0.7
Acid detergent fibre (%)	3.1	0.5	Eicosenoic acid C20:1	1.3	0.1
Acid detergent lignin (%)	1.0	0.3			
Water insoluble cell walls (%)	9.7	0.8	Fatty acids/ether extract (%)	75	
Starch (%)	60.5	1.9			
Total sugars (%)	2.4	0.8			
Gross energy (MJ/kg)	15.8	0.3			

Mineral elements	mean	sd	Vitamins	mean
Calcium (g/kg)	0.7	0.3	Vitamin A (1000 UI/kg)	0.16
Phosphorus (g/kg)	3.2	0.3	Vitamin E (mg/kg)	15
Phytate P / total P (%)	65		Vitamin B1 - thiamin (mg/kg)	4
Magnesium (g/kg)	1.0	0.2	Vitamin B2 - riboflavin (mg/kg)	1.2
Potassium (g/kg)	4.0	0.4	Vitamin B6 - pyridoxine (mg/kg)	3
Sodium (g/kg)	0.1	0.1	Vitamin B12 (µg/kg)	0
Chlorine (g/kg)	0.9	0.3	Niacin (mg/kg)	54
Sulphur (mg/kg)	1.5		Pantothenic acid (mg/kg)	11
DCAD (mEq/kg)	-16		Folic acid (mg/kg)	0.47
EB (mEq/kg)	79		Biotin (mg/kg)	0.09
Manganese (mg/kg)	34	13	Vitamin C (mg/kg)	0
Zinc (mg/kg)	27	8	Choline (%)	919
Copper (mg/kg)	5	1.0		
Iron (mg/kg)	47	14		
Selenium (mg/kg)	0.12			
Cobalt (mg/kg)	0.02			
Molybdenum (mg/kg)	0.46			
Iodine (mg/kg)	0.06			
			Other	mean
			Real applied viscosity (ml/g)	1.9
			Phytase activity (UI/kg)	460

Pigs	Growing	Sow	Poultry	Cockerel	Broiler
DE (MJ/kg)	13.9	14.1	AMEn (MJ/kg)	12.5	12.1
ME (MJ/kg)	13.4	13.6	P availability (%)		58
NE (MJ/kg)	10.5	10.6	Horses		
Ed (%)	88	89	UFC (per kg)	1.07	
OMd (%)	90	92	MADC (g/kg)	86	
Nd (%)	84	87	Rabbits		
NSId (%)		88	DE (MJ/kg)	12.9	
EEEd (%)		24	MEEn (MJ/kg)	12.5	
Pd (%)		30	Ed (%)	82	
P _{Phy} d (%)		45	Nd (%)	77	
Ruminants			Fish		
UFL (per kg)		1.02	DE (MJ/kg)	12.6	
UFV (per kg)		1.02	DE extruded (MJ/kg)	11.0	
PDIA (g/kg)		26	Ed (%)	80	
PDIN (g/kg)		70	Ed extruded (%)	69	
PDIE (g/kg)		89	Nd (%)	90	
ME (kcal/kg)		11.3	Nd extruded (%)	86	
Ed (%)		86			
OMd (%)		88			
Nd (%)		70			
TId (%)		92			
FAd (%)		63			
Absorbed phosphorus (g/kg)		2.3			
<i>Ruminal degradation</i>	<i>Nitrogen</i>	<i>Starch</i>	<i>DM</i>		
Effective degradability	76	94	80		
a (%)	27	58	52		
b (%)	67	42	42		
c (%/h)	16.0	39.0	12.0		

Amino acid content and digestibility

Amino acids	Total		Pigs				Poultry		Ruminants
	g/kg	% CP	AID	AIDC	SID	SIDC	TD	TDC	AADI
			%	g/kg	%	g/kg	%	g/kg	% PDIE
LYS	3.1	2.9	74	2.3	81	2.5	84	2.6	6.7
THR	3.2	3.1	75	2.4	83	2.7	83	2.7	5.0
MET	1.7	1.6	86	1.5	89	1.5	90	1.5	1.9
CYS	2.6	2.5	86	2.2	91	2.4	91	2.4	
MET+CYS	4.2	4.0	86	3.6	90	3.7	91	3.8	
TRP	1.3	1.2	83	1.1	88	1.1			
ILE	3.8	3.6	84	3.2	89	3.4	90	3.4	5.2
VAL	4.7	4.4	80	3.8	86	4.0	88	4.1	5.6
LEU	7.1	6.8	86	6.1	90	6.4	91	6.5	8.0
PHE	4.9	4.7	88	4.3	91	4.5	92	4.5	5.0
TYR	3.3	3.1	85	2.8	90	3.0	88	2.9	
PHE+TYR	7.8	7.4	87	6.7	91	7.1	90	7.0	
HIS	2.4	2.3	86	2.1	90	2.2	90	2.2	2.0
ARG	5.3	5.1	84	4.5	88	4.7	87	4.6	4.7
ALA	3.9	3.7	73	2.8	80	3.1	84	3.2	
ASP	5.5	5.2	76	4.2	83	4.6	85	4.7	
GLU	30.0	28.4	94	28.1	95	28.6	96	28.8	
GLY	4.4	4.1	77	3.4	86	3.7	82	3.6	
SER	5.2	5.0	85	4.4	89	4.7	90	4.7	
PRO	10.4	9.9	91	9.5	95	9.9	96	10.0	

Wheat bran

By-product from soft wheat milling. It consists principally of fragments of the outer skins and of particles of grain from which the greater part of the endosperm has been removed (n = 5542).

All values are expressed on an as fed basis unless otherwise noted.

Main constituents	mean	sd	Fatty acids	%FA	g/kg
Dry matter (%)	87.1	1.1	Myristic acid C14:0	0.1	0.0
Crude protein (%)	14.8	0.9	Palmitic acid C16:0	17.8	4.9
Crude fibre (%)	9.2	1.2	Palmitoleic acid C16:1	0.4	0.1
Ether extract (%)	3.4	0.5	Stearic acid C18:0	0.8	0.2
Ash (%)	5.0	0.5	Oleic acid C18:1	15.2	4.2
Insoluble ash (%)	0.1		Linoleic acid C18:2	56.4	15.6
Neutral detergent fibre (%)	39.6	4.2	Linolenic acid C18:3	5.9	1.6
Acid detergent fibre (%)	11.9	1.3	Eicosenoic acid C20:1	1.3	0.4
Acid detergent lignin (%)	3.4	0.6			
Water insoluble cell walls (%)	38.5	5.0	Fatty acids/ether extract (%)	80	
Starch (%)	19.8	3.2			
Total sugars (%)	6.7	1.7			
Gross energy (MJ/kg)	16.4	0.5			

Mineral elements	mean	sd	Vitamins	mean
Calcium (g/kg)	1.4	0.5	Vitamin A (1000 UI/kg)	0.48
Phosphorus (g/kg)	9.9	1.1	Vitamin E (mg/kg)	18
Phytate P / total P (%)	80		Vitamin K (mg/kg)	0.80
Magnesium (g/kg)	4.2	2.0	Vitamin B1 - thiamin (mg/kg)	8
Potassium (g/kg)	12.3	2.5	Vitamin B2 - riboflavin (mg/kg)	4
Sodium (g/kg)	0.1	0.1	Vitamin B6 - pyridoxine (mg/kg)	10
Chlorine (g/kg)	0.9	0.2	Vitamin B12 (µg/kg)	0
Sulphur (mg/kg)	1.9		Niacin (mg/kg)	192
DCAD (mEq/kg)	178		Pantothenic acid (mg/kg)	28
EB (mEq/kg)	295		Folic acid (mg/kg)	1.4
Manganese (mg/kg)	112		Biotin (mg/kg)	0.33
Zinc (mg/kg)	74	25	Choline (%)	736
Copper (mg/kg)	17	25		
Iron (mg/kg)	143	67		
Selenium (mg/kg)	0.47	0.13		
Cobalt (mg/kg)	0.09			
Molybdenum (mg/kg)	1.4			
Iodine (mg/kg)	0.08			
			Other	mean
			Real applied viscosity (ml/g)	2.0
			Phytase activity (UI/kg)	1770

Pigs	Growing	Sow	Poultry	Cockerel	Broiler
DE (MJ/kg)	9.3	10.3	AMEn (MJ/kg)	7.0	6.7
ME (MJ/kg)	8.8	9.6	P availability (%)		
NE (MJ/kg)	6.3	6.8	Horses		
Ed (%)	57	63	UFC (per kg)	0.75	
OMd (%)	61	66	MADC (g/kg)	116	
Nd (%)	65	74	Rabbits		
NSId (%)		68	DE (MJ/kg)	10.3	
EEEd (%)		41	MEEn (MJ/kg)	9.7	
Pd (%)		25	Ed (%)	63	
P _{Phy} d (%)		50	Nd (%)	74	
Ruminants			Fish		
UFL (per kg)		0.82	DE (MJ/kg)		
UFV (per kg)		0.77	Ed (%)		
PDIA (g/kg)		33	Nd (%)		
PDIN (g/kg)		94			
PDIE (g/kg)		80			
ME (kcal/kg)		9.6			
Ed (%)		71			
OMd (%)		73			
Nd (%)		68			
TId (%)		80			
FAd (%)		73			
Absorbed phosphorus (g/kg)		7.5			
<i>Ruminal degradation</i>	<i>Nitrogen</i>	<i>Starch</i>	<i>DM</i>		
Effective degradability	75	95	61		
a (%)	35	78	36		
b (%)	54	22	42		
c (%/h)	16.5	20.5	9.0		

Amino acid content and digestibility

Amino acids	Total		Pigs				Poultry		Ruminants
	g/kg	% CP	AID	AIDC	SID	SIDC	TD	TDC	AADI
			%	g/kg	%	g/kg	%	g/kg	% PDIE
LYS	5.8	3.9	63	3.6	68	4.0	74	4.3	6.7
THR	4.7	3.2	57	2.7	65	3.0	75	3.5	5.0
MET	2.3	1.5	72	1.6	76	1.7	74	1.7	1.9
CYS	3.1	2.1	66	2.1	72	2.3	75	2.4	
MET+CYS	5.4	3.7	69	3.7	74	4.0	75	4.0	
TRP	1.9	1.3	70	1.3	76	1.4			
ILE	4.7	3.2	67	3.2	74	3.5	76	3.6	5.1
VAL	6.7	4.5	66	4.4	72	4.8	75	5.0	5.7
LEU	9.1	6.2	69	6.3	75	6.9	79	7.2	8.0
PHE	5.8	4.0	73	4.3	79	4.6	80	4.7	4.9
TYR	3.6	2.4	72	2.6	80	2.9			
PHE+TYR	9.4	6.4	73	6.9	79	7.5			
HIS	3.8	2.6	74	2.8	79	3.0	82	3.1	2.2
ARG	9.1	6.2	81	7.4	84	7.6	84	7.6	5.0
ALA	6.3	4.2	60	3.8	66	4.1			
ASP	9.4	6.4	65	6.1	71	6.6			
GLU	29.8	20.2	83	24.6	86	25.6			
GLY	7.0	4.8	58	4.1	65	4.5			
SER	6.4	4.3	67	4.3	74	4.7			
PRO	9.8	6.6	76	7.4	81	7.9			

Wheat middlings

By-product from soft wheat milling. It consists principally of fragments of the outer skins and of particles of grain from which less of the endosperm has been removed than in wheat bran (n = 1338).

All values are expressed on an as fed basis unless otherwise noted.

Main constituents	mean	sd	Fatty acids	%FA	g/kg
Dry matter (%)	88.1	1.0	Myristic acid C14:0	0.1	0.0
Crude protein (%)	15.5	1.1	Palmitic acid C16:0	17.8	5.1
Crude fibre (%)	7.0	1.3	Palmitoleic acid C16:1	0.4	0.1
Ether extract (%)	3.6	0.6	Stearic acid C18:0	0.8	0.2
Ash (%)	4.3	0.6	Oleic acid C18:1	15.2	4.3
Insoluble ash (%)	0.2	0.1	Linoleic acid C18:2	56.4	16.1
Neutral detergent fibre (%)	31.3	5.6	Linolenic acid C18:3	5.9	1.7
Acid detergent fibre (%)	9.2	1.8	Eicosenoic acid C20:1	1.3	0.4
Acid detergent lignin (%)	2.6	0.7			
Water insoluble cell walls (%)	30.7		Fatty acids/ether extract (%)	80	
Starch (%)	27.7	5.2			
Total sugars (%)	6.2	2.2			
Gross energy (MJ/kg)	16.7	0.3			

Mineral elements	mean	sd	Vitamins	mean
Calcium (g/kg)	1.3	0.4	Vitamin E (mg/kg)	25
Phosphorus (g/kg)	8.7	1.4	Vitamin B1 - thiamin (mg/kg)	16
Phytate P / total P (%)	80		Vitamin B2 - riboflavin (mg/kg)	2
Magnesium (g/kg)	3.5		Vitamin B6 - pyridoxine (mg/kg)	8
Potassium (g/kg)	10.9	0.9	Vitamin B12 (µg/kg)	0
Sodium (g/kg)	0.1	0.1	Niacin (mg/kg)	102
Chlorine (g/kg)	1.0	0.2	Pantothenic acid (mg/kg)	18
Sulphur (mg/kg)	1.6		Folic acid (mg/kg)	1.1
DCAD (mEq/kg)	152		Biotin (mg/kg)	0.24
EB (mEq/kg)	255		Choline (%)	1174
Manganese (mg/kg)	100			
Zinc (mg/kg)	91	20		
Copper (mg/kg)	12	2		
Iron (mg/kg)	94			
Selenium (mg/kg)	0.62			
Molybdenum (mg/kg)	2			
Iodine (mg/kg)	0.09			
			Other	mean
			Real applied viscosity (ml/g)	2.0
			Phytase activity (UI/kg)	2590

Pigs	Growing	Sow	Poultry	Cockerel	Broiler
DE (MJ/kg)	11.1	11.9	AMEn (MJ/kg)	8.6	8.2
ME (MJ/kg)	10.6	11.2	P availability (%)		
NE (MJ/kg)	7.7	8.1	Horses		
Ed (%)	66	71	UFC (per kg)	0.85	
OMd (%)	70	74	MADC (g/kg)	123	
Nd (%)	71	78	Rabbits		
NSId (%)		76	DE (MJ/kg)	11.4	
EEEd (%)		47	MEEn (MJ/kg)	10.8	
Pd (%)		25	Ed (%)	68	
P _{Phy} d (%)		50	Nd (%)	77	
Ruminants			Fish		
UFL (per kg)		0.90	DE (MJ/kg)	7.5	
UFV (per kg)		0.87	Ed (%)	45	
PDIA (g/kg)		36	Nd (%)	89	
PDIN (g/kg)		101	Pd (%)	48	
PDIE (g/kg)		87			
ME (kcal/kg)		10.4			
Ed (%)		76			
OMd (%)		78			
Nd (%)		70			
TId (%)		87			
FAd (%)		73			
Absorbed phosphorus (g/kg)		6.5			
<i>Ruminal degradation</i>	<i>Nitrogen</i>	<i>Starch</i>	<i>DM</i>		
Effective degradability	76	95	64		
a (%)			44		
b (%)			38		
c (%/h)			6.5		

Amino acid content and digestibility

Amino acids	Total		Pigs				Poultry		Ruminants
	g/kg	% CP	AID	AIDC	SID	SIDC	TD	TDC	AADI
			%	g/kg	%	g/kg	%	g/kg	% PDIE
LYS	6.2	4.0	70	4.3	75	4.6	81	5.0	6.7
THR	4.9	3.2	65	3.2	72	3.6	79	3.9	4.9
MET	2.4	1.5	78	1.8	82	1.9	80	1.9	1.9
CYS	3.1	2.0	72	2.3	78	2.4	72	2.2	
MET+CYS	5.5	3.6	75	4.1	79	4.4	75	4.2	
TRP	2.0	1.3	75	1.5	80	1.6			
ILE	5.0	3.2	74	3.7	80	4.0	82	4.1	5.1
VAL	7.0	4.5	72	5.0	78	5.4	82	5.7	5.6
LEU	9.5	6.1	76	7.1	81	7.7	85	8.0	8.0
PHE	6.1	3.9	79	4.8	84	5.1	86	5.2	4.8
TYR	4.1	2.6	77	3.1	84	3.4			
PHE+TYR	10.2	6.6	78	7.9	84	8.5			
HIS	4.0	2.6	80	3.2	84	3.3	84	3.3	2.2
ARG	9.7	6.3	85	8.2	88	8.5	87	8.5	5.0
ALA	6.7	4.3	66	4.4	72	4.8			
ASP	10.1	6.5	70	7.1	76	7.7			
GLU	31.1	20.2	86	26.9	89	27.8			
GLY	7.4	4.8	66	4.9	73	5.4			
SER	9.5	6.1	74	7.0	80	7.5			
PRO	10.3	6.6							

Wheat shorts

By-product from soft wheat milling. It consists principally of particles of endosperm with more fragments of the outer skins than in the wheat feed flour (n = 436).

All values are expressed on an as fed basis unless otherwise noted.

Main constituents	mean	sd	Fatty acids	%FA	g/kg
Dry matter (%)	87.9	1.1	Myristic acid C14:0	0.1	0.0
Crude protein (%)	14.9	1.4	Palmitic acid C16:0	17.8	5.0
Crude fibre (%)	4.9	1.2	Palmitoleic acid C16:1	0.4	0.1
Ether extract (%)	3.5	0.8	Stearic acid C18:0	0.8	0.2
Ash (%)	3.4	0.6	Oleic acid C18:1	15.2	4.2
Neutral detergent fibre (%)	22.9	5.7	Linoleic acid C18:2	56.4	15.7
Acid detergent fibre (%)	6.5	1.4	Linolenic acid C18:3	5.9	1.6
Acid detergent lignin (%)	1.9	0.4	Eicosenoic acid C20:1	1.3	0.4
Water insoluble cell walls (%)	22.9				
Starch (%)	37.8	7.0	Fatty acids/ether extract (%)	80	
Total sugars (%)	5.5				
Gross energy (MJ/kg)	16.7				

Mineral elements	mean	sd	Vitamins	mean
Calcium (g/kg)	1.2	0.3	Vitamin E (mg/kg)	54
Phosphorus (g/kg)	7.1		Vitamin B1 - thiamin (mg/kg)	18
Phytate P / total P (%)	80		Vitamin B2 - riboflavin (mg/kg)	3
Magnesium (g/kg)	2.3		Vitamin B6 - pyridoxine (mg/kg)	7
Potassium (g/kg)	9.1		Vitamin B12 (µg/kg)	0
Sodium (g/kg)	0.1		Niacin (mg/kg)	107
Chlorine (g/kg)	0.8		Folic acid (mg/kg)	1.4
Sulphur (mg/kg)	2.0		Biotin (mg/kg)	0.24
DCAD (mEq/kg)	88		Choline (%)	1168
EB (mEq/kg)	215			
Manganese (mg/kg)	97			
Zinc (mg/kg)	81			
Copper (mg/kg)	14			
Iron (mg/kg)	116			
Selenium (mg/kg)	0.71			
Cobalt (mg/kg)	0.10			
Molybdenum (mg/kg)	0.07			
Iodine (mg/kg)	0.11			
			Other	mean
			Real applied viscosity (ml/g)	2.0
			Phytase activity (UI/kg)	3380

Pigs	Growing	Sow	Poultry	Cockerel	Broiler
DE (MJ/kg)	12.6	13.2	AMEn (MJ/kg)	10.0	9.6
ME (MJ/kg)	12.1	12.6	P availability (%)		
NE (MJ/kg)	9.0	9.3	Horses		
Ed (%)	76	79	UFC (per kg)	0.99	
OMd (%)	78	82	MADC (g/kg)	122	
Nd (%)	76	82	Rabbits		
NSId (%)		82	DE (MJ/kg)	12.3	
EEEd (%)		51	MEEn (MJ/kg)	11.7	
Pd (%)		25	Ed (%)	74	
P _{Phy} d (%)		50	Nd (%)	79	
Ruminants			Fish		
UFL (per kg)		0.98	DE (MJ/kg)		
UFV (per kg)		0.96	Ed (%)		
PDIA (g/kg)		35	Nd (%)		
PDIN (g/kg)		98			
PDIE (g/kg)		90			
ME (kcal/kg)		11.1			
Ed (%)		81			
OMd (%)		83			
Nd (%)		71			
TId (%)		87			
FAd (%)		73			
Absorbed phosphorus (g/kg)		5.3			
<i>Ruminal degradation</i>	<i>Nitrogen</i>	<i>Starch</i>	<i>DM</i>		
Effective degradability	76	95	72		
a (%)	35		46		
b (%)	57		38		
c (%/h)	15.5		13.0		

Amino acid content and digestibility

Amino acids	Total		Pigs				Poultry		Ruminants
	g/kg	% CP	AID	AIDC	SID	SIDC	TD	TDC	AADI
			%	g/kg	%	g/kg	%	g/kg	% PDIE
LYS	5.9	3.9	76	4.5	82	4.8			6.8
THR	4.7	3.2	72	3.4	79	3.7			5.0
MET	2.3	1.5	83	1.9	87	2.0			1.9
CYS	3.0	2.0	78	2.4	83	2.5			
MET+CYS	5.3	3.6	81	4.3	85	4.5			
TRP	1.9	1.3	79	1.5	84	1.6			
ILE	4.8	3.2	80	3.8	85	4.1			5.1
VAL	6.7	4.5	78	5.2	83	5.6			5.7
LEU	9.2	6.2	82	7.5	86	7.9			8.0
PHE	5.9	4.0	84	4.9	88	5.2			4.9
TYR	3.6	2.4	82	3.0	88	3.2			
PHE+TYR	9.5	6.4	83	7.9	88	8.4			
HIS	3.8	2.6	85	3.3	88	3.4			2.2
ARG	9.2	6.2	88	8.1	91	8.3			5.0
ALA	6.3	4.2	73	4.6	78	4.9			
ASP	9.5	6.4	76	7.2	82	7.7			
GLU	30.0	20.2	90	27.1	93	27.8			
GLY	7.1	4.8	73	5.2	80	5.7			
SER	6.5	4.3	80	5.2	85	5.5			
PRO	9.9	6.6	85	8.4	89	8.8			

Wheat feed flour

By-product from soft wheat milling. It consists principally of particles of endosperm with fine fragments of the outer skins (n = 391).

All values are expressed on an as fed basis unless otherwise noted.

Main constituents	mean	sd	Fatty acids	%FA	g/kg
Dry matter (%)	88.2	1.5	Myristic acid C14:0	0.1	0.0
Crude protein (%)	12.7	1.6	Palmitic acid C16:0	17.8	3.4
Crude fibre (%)	1.5	0.8	Palmitoleic acid C16:1	0.4	0.1
Ether extract (%)	2.4	0.7	Stearic acid C18:0	0.8	0.2
Ash (%)	1.4	0.6	Oleic acid C18:1	15.2	2.9
Neutral detergent fibre (%)	9.8	3.1	Linoleic acid C18:2	56.4	10.7
Acid detergent fibre (%)	2.2	0.6	Linolenic acid C18:3	5.9	1.1
Acid detergent lignin (%)	0.4	0.1	Eicosenoic acid C20:1	1.3	0.2
Water insoluble cell walls (%)	10.5				
Starch (%)	59.7	6.0	Fatty acids/ether extract (%)	80	
Total sugars (%)	4.0	0.9			
Gross energy (MJ/kg)	16.7	0.9			

Mineral elements	mean	sd	Vitamins	mean
Calcium (g/kg)	0.9	0.4	Vitamin B1 - thiamin (mg/kg)	23
Phosphorus (g/kg)	3.6		Vitamin B2 - riboflavin (mg/kg)	2
Phytate P / total P (%)	80		Vitamin B6 - pyridoxine (mg/kg)	5
Magnesium (g/kg)	1.6		Niacin (mg/kg)	42
Potassium (g/kg)	5.3		Folic acid (mg/kg)	0.80
Sodium (g/kg)	0.2		Biotin (mg/kg)	0.11
Chlorine (g/kg)	0.6		Choline (%)	1537
Sulphur (mg/kg)	1.5			
DCAD (mEq/kg)	35			
EB (mEq/kg)	127			
Manganese (mg/kg)	50			
Zinc (mg/kg)	40			
Copper (mg/kg)	6			
Iron (mg/kg)	14			

Other	mean
Real applied viscosity (ml/g)	2.0
Phytase activity (UI/kg)	3080

Pigs	Growing	Sow	Poultry	Cockerel	Broiler
DE (MJ/kg)	15.0	15.2	AMEn (MJ/kg)	12.3	11.9
ME (MJ/kg)	14.6	14.7	P availability (%)		
NE (MJ/kg)	11.2	11.3	Horses		
Ed (%)	90	91	UFC (per kg)	1.09	
OMd (%)	92	94	MADC (g/kg)	104	
Nd (%)	86	88	Rabbits		
NSId (%)		93	DE (MJ/kg)	13.9	
EEd (%)		48	MEEn (MJ/kg)	13.3	
Pd (%)		25	Ed (%)	83	
Ruminants			Nd (%)	84	
UFL (per kg)		1.10	Fish		
UFV (per kg)		1.11	DE (MJ/kg)		
PDIA (g/kg)		31	Ed (%)		
PDIN (g/kg)		84	Nd (%)		
PDIE (g/kg)		95			
ME (kcal/kg)		12.2			
Ed (%)		88			
OMd (%)		90			
Nd (%)		73			
TId (%)		90			
FAd (%)		69			
Absorbed phosphorus (g/kg)		2.7			
Ruminal degradation	Nitrogen	Starch	DM		
Effective degradability	76	95	80		
a (%)					
b (%)					
c (%/h)					

Amino acid content and digestibility

Amino acids	Total		Pigs				Poultry		Ruminants
	g/kg	% CP	AID	AIDC	SID	SIDC	TD	TDC	AADI
			%	g/kg	%	g/kg	%	g/kg	% PDIE
LYS	4.6	3.6	87	4.0	92	4.3			6.8
THR	3.8	3.0	83	3.2	90	3.4			5.0
MET	1.9	1.5	92	1.8	95	1.8			1.9
CYS	2.6	2.0	88	2.3	92	2.4			
MET+CYS	4.5	3.5	90	4.0	93	4.2			
TRP	1.5	1.2	85	1.3	91	1.4			
ILE	4.0	3.1	89	3.6	94	3.8			5.2
VAL	5.7	4.5	87	4.9	92	5.2			5.7
LEU	8.2	6.4	91	7.5	95	7.8			8.1
PHE	5.1	4.0	92	4.7	96	4.9			4.9
TYR	1.8	1.4	90	1.6	95	1.7			
PHE+TYR	6.9	5.4	91	6.3	95	6.6			
HIS	3.3	2.6	93	3.1	96	3.2			2.1
ARG	6.8	5.4	93	6.4	96	6.6			4.8
ALA	5.0	3.9	83	4.1	88	4.4			
ASP	7.1	5.6	85	6.0	90	6.4			
GLU	32.8	25.7	96	31.4	98	31.9			
GLY	5.9	4.6	85	5.0	92	5.4			
SER	5.6	4.4	90	5.0	94	5.3			
PRO	8.5	6.6	94	7.9	97	8.3			

Wheat bran, durum

By-product from durum wheat processing. It consists principally of fragments of the outer skins and of particles of grain from which the greater part of the endosperm has been removed (n = 142).

All values are expressed on an as fed basis unless otherwise noted.

Main constituents	mean	sd	Fatty acids	%FA	g/kg
Dry matter (%)	86.6	1.1	Fatty acids/ether extract (%)	80	
Crude protein (%)	14.6	1.1			
Crude fibre (%)	10.1	1.1			
Ether extract (%)	4.4	0.4			
Ash (%)	4.9	0.4			
Insoluble ash (%)	0.1				
Neutral detergent fibre (%)	43.2				
Acid detergent fibre (%)	13.0				
Acid detergent lignin (%)	3.7				
Water insoluble cell walls (%)	41.8				
Starch (%)	19.9	3.3			
Total sugars (%)	6.6				
Gross energy (MJ/kg)	16.6				

Mineral elements	mean	sd
Calcium (g/kg)	1.4	
Phosphorus (g/kg)	9.7	
Magnesium (g/kg)	2.7	
Potassium (g/kg)	11.9	
Sodium (g/kg)	0.1	
Chlorine (g/kg)	0.8	
EB (mEq/kg)	290	

Pigs	Growing	Sow	Poultry	Cockerel	Broiler
DE (MJ/kg)	8.7	9.8	AMEn (MJ/kg)		
ME (MJ/kg)	8.2	9.2	P availability (%)		
NE (MJ/kg)	6.0	6.6	Horses		
Ed (%)	52	59	UFC (per kg)	0.77	
OMd (%)	56	63	MADC (g/kg)	121	
Nd (%)	62	72	Rabbits		
EEd (%)		48	DE (MJ/kg)		
Ruminants			MEEn (MJ/kg)		
UFL (per kg)		0.80	Ed (%)		
UFV (per kg)		0.74	Nd (%)		
PDIA (g/kg)		31	Fish		
PDIN (g/kg)		93	DE (MJ/kg)		
PDIE (g/kg)		75	Ed (%)		
ME (kcal/kg)		9.4	Nd (%)		
Ed (%)		69			
OMd (%)		71			
Nd (%)		67			
TId (%)		80			
FAd (%)		74			
Ruminal degradation	Nitrogen	Starch	DM		
Effective degradability	76	95	55		
a (%)					
b (%)					
c (%/h)					

Amino acid content and digestibility

Amino acids	Total		Pigs				Poultry		Ruminants
	g/kg	% CP	AID %	AIDC g/kg	SID %	SIDC g/kg	TD %	TDC g/kg	AADI % PDIE
LYS	5.7	3.9							6.7
THR	4.6	3.1							5.0
MET	2.2	1.5							1.9
CYS	3.1	2.1							
MET+CYS	5.4	3.7							
TRP	1.9	1.3							
ILE	4.7	3.2							5.1
VAL	6.6	4.5							5.7
LEU	9.0	6.2							8.0
PHE	5.8	4.0							4.9
TYR	3.5	2.4							
PHE+TYR	9.3	6.4							
HIS	3.8	2.6							2.2
ARG	9.0	6.1							5.0
ALA	6.2	4.2							
ASP	9.3	6.3							
GLU	29.5	20.2							
GLY	7.0	4.8							
SER	6.4	4.3							
PRO	9.7	6.6							

Wheat middlings, durum

By-product from durum wheat processing. It consists principally of fragments of the outer skins and of particles of grain from which less of the endosperm has been removed than in wheat bran (n = 528).

All values are expressed on an as fed basis unless otherwise noted.

Main constituents	mean	sd	Fatty acids	%FA	g/kg
Dry matter (%)	86.9	1.0	Fatty acids/ether extract (%)	80	
Crude protein (%)	15.4	0.9			
Crude fibre (%)	7.1	1.0			
Ether extract (%)	4.3	0.5			
Ash (%)	4.0	0.4			
Neutral detergent fibre (%)	31.6				
Acid detergent fibre (%)	9.3				
Acid detergent lignin (%)	2.7				
Water insoluble cell walls (%)	31.0				
Starch (%)	29.7	3.8			
Total sugars (%)	5.9				
Gross energy (MJ/kg)	16.7				

Mineral elements	mean	sd
Calcium (g/kg)	1.2	
Phosphorus (g/kg)	8.1	
Potassium (g/kg)	10.3	
Sodium (g/kg)	0.2	
Chlorine (g/kg)	0.7	
EB (mEq/kg)	250	

Pigs	Growing	Sow	Poultry	Cockerel	Broiler
DE (MJ/kg)	11.0	11.8	AMEn (MJ/kg)		
ME (MJ/kg)	10.5	11.1	P availability (%)		
NE (MJ/kg)	7.7	8.2	Horses		
Ed (%)	66	70	UFC (per kg)	0.85	
OMd (%)	69	73	MADC (g/kg)	127	
Nd (%)	70	77	Rabbits		
EEd (%)		53	DE (MJ/kg)		
Ruminants			MEEn (MJ/kg)		
UFL (per kg)		0.90	Ed (%)		
UFV (per kg)		0.87	Nd (%)		
PDIA (g/kg)		35	Fish		
PDIN (g/kg)		100	DE (MJ/kg)		
PDIE (g/kg)		85	Ed (%)		
ME (kcal/kg)		10.4	Nd (%)		
Ed (%)		76	Pd (%)		
OMd (%)		78			
Nd (%)		70			
TId (%)		85			
FAd (%)		74			
Ruminal degradation	Nitrogen	Starch	DM		
Effective degradability	76	95	65		
a (%)					
b (%)					
c (%/h)					

Amino acid content and digestibility

Amino acids	Total		Pigs				Poultry		Ruminants
	g/kg	% CP	AID %	AIDC g/kg	SID %	SIDC g/kg	TD %	TDC g/kg	AADI % PDIE
LYS	6.2	4.0							6.7
THR	4.9	3.2							4.9
MET	2.4	1.5							1.9
CYS	3.1	2.0							
MET+CYS	5.5	3.6							
TRP	2.0	1.3							
ILE	5.0	3.2							5.1
VAL	7.0	4.5							5.6
LEU	9.4	6.1							7.9
PHE	6.1	3.9							4.8
TYR	4.2	2.7							
PHE+TYR	10.3	6.6							
HIS	4.0	2.6							2.2
ARG	9.8	6.4							5.0
ALA	6.7	4.3							
ASP	10.1	6.6							
GLU	31.1	20.2							
GLY	7.4	4.8							
SER	9.4	6.1							
PRO	10.3	6.6							

Wheat distillers' grains, starch < 7%

Dried by-product from wheat ethanol distillery, composed of spent grains, bran and soluble fractions. The final product contains less than 7 % starch (as fed) (n = 64).

All values are expressed on an as fed basis unless otherwise noted.

Main constituents	mean	sd	Fatty acids	%FA	g/kg
Dry matter (%)	90.0	1.9	Myristic acid C14:0	0.1	0.0
Crude protein (%)	33.8	2.9	Palmitic acid C16:0	17.8	7.5
Crude fibre (%)	9.2	2.0	Palmitoleic acid C16:1	0.4	0.2
Ether extract (%)	6.5	2.6	Stearic acid C18:0	0.8	0.3
Ash (%)	3.6	0.9	Oleic acid C18:1	15.2	6.4
Insoluble ash (%)	0.0		Linoleic acid C18:2	56.4	23.7
Neutral detergent fibre (%)	37.9	8.1	Linolenic acid C18:3	5.9	2.5
Acid detergent fibre (%)	14.6	2.0	Eicosenoic acid C20:1	1.3	0.5
Acid detergent lignin (%)	4.0	1.3			
Water insoluble cell walls (%)	36.4		Fatty acids/ether extract (%)	65	
Starch (%)	3.8	1.1			
Total sugars (%)	0.8	0.6			
Gross energy (MJ/kg)	19.3	0.6			

Mineral elements	mean	sd
Calcium (g/kg)	3.3	1.2
Phosphorus (g/kg)	6.7	1.4
Magnesium (g/kg)	2.7	
Potassium (g/kg)	7.9	
Sodium (g/kg)	0.5	
Chlorine (g/kg)	1.9	
EB (mEq/kg)	170	
Iodine (mg/kg)	0.18	

Pigs	Growing	Sow	Poultry	Cockerel	Broiler
DE (MJ/kg)	11.3	12.3	AMEn (MJ/kg)	7.8	7.6
ME (MJ/kg)	10.5	11.2	P availability (%)		
NE (MJ/kg)	6.7	7.2	Horses		
Ed (%)	59	64	UFC (per kg)		
OMd (%)	62	67	MADC (g/kg)		
Nd (%)	65	70	Rabbits		
EEd (%)		61	DE (MJ/kg)		
Ruminants			MEEn (MJ/kg)		
UFL (per kg)		0.96	Ed (%)		
UFV (per kg)		0.90	Nd (%)		
PDIA (g/kg)		102	Fish		
PDIN (g/kg)		228	DE (MJ/kg)		
PDIE (g/kg)		143	Ed (%)		
ME (kcal/kg)		11.2	Nd (%)		
Ed (%)		75			
OMd (%)		74			
Nd (%)		76			
TId (%)		85			
FAd (%)		75			
Absorbed phosphorus (g/kg)		4.6			
<i>Ruminal degradation</i>	<i>Nitrogen</i>	<i>Starch</i>	<i>DM</i>		
Effective degradability	68	94	69		
a (%)	36		48		
b (%)	58		44		
c (%/h)	7.5		5.5		

Amino acid content and digestibility

Amino acids	Total		Pigs				Poultry		Ruminants
	g/kg	% CP	AID %	AIDC g/kg	SID %	SIDC g/kg	TD %	TDC g/kg	AADI % PDIE
LYS	10.5	3.1							5.5
THR	11.6	3.4							4.8
MET	6.3	1.9							2.0
CYS	8.1	2.4							
MET+CYS	14.4	4.2							
TRP	5.1	1.5							
ILE	11.2	3.3							4.8
VAL	12.1	3.6							5.0
LEU	16.1	4.7							7.1
PHE	16.0	4.7							5.5
TYR	9.1	2.7							
PHE+TYR	25.1	7.4							
HIS	6.9	2.0							2.2
ARG	15.2	4.5							4.8
ALA	11.2	3.3							
ASP	13.5	4.0							
GLU	85.4	25.2							
GLY	12.1	3.6							
SER	13.4	4.0							
PRO	21.4	6.3							

Wheat distillers' grains, starch > 7%

Dried by-product from wheat ethanol distillery, composed of spent grains, bran and soluble fractions. The final product contains more than 7 % starch (as fed) (n = 25).

All values are expressed on an as fed basis unless otherwise noted.

Main constituents	mean	sd	Fatty acids	%FA	g/kg
Dry matter (%)	91.4	1.1	Myristic acid C14:0	0.1	0.0
Crude protein (%)	28.9	2.4	Palmitic acid C16:0	17.8	5.9
Crude fibre (%)	5.6	1.1	Palmitoleic acid C16:1	0.4	0.1
Ether extract (%)	5.1	1.6	Stearic acid C18:0	0.8	0.3
Ash (%)	4.7	0.8	Oleic acid C18:1	15.2	5.0
Neutral detergent fibre (%)	25.3	6.5	Linoleic acid C18:2	56.4	18.6
Acid detergent fibre (%)	8.4	3.5	Linolenic acid C18:3	5.9	1.9
Acid detergent lignin (%)	2.5	1.2	Eicosenoic acid C20:1	1.3	0.4
Water insoluble cell walls (%)	23.8				
Starch (%)	12.6	4.3	Fatty acids/ether extract (%)	65	
Total sugars (%)	3.5				
Gross energy (MJ/kg)	18.6				

Mineral elements	mean	sd
Calcium (g/kg)	1.9	0.9
Phosphorus (g/kg)	8.1	0.7
Magnesium (g/kg)	2.8	
Potassium (g/kg)	8.0	
Sodium (g/kg)	0.5	
Chlorine (g/kg)	1.9	
EB (mEq/kg)	173	
Iodine (mg/kg)	0.18	

Pigs	Growing	Sow	Poultry	Cockerel	Broiler
DE (MJ/kg)	13.7	14.3	AMEn (MJ/kg)	10.0	9.8
ME (MJ/kg)	12.8	13.2	P availability (%)		
NE (MJ/kg)	8.5	8.9	Horses		
Ed (%)	74	77	UFC (per kg)		
OMd (%)	76	79	MADC (g/kg)		
Nd (%)	75	78	Rabbits		
NSId (%)		82	DE (MJ/kg)		
EEd (%)		59	MEEn (MJ/kg)		
Ruminants			Ed (%)		
UFL (per kg)		1.04	Nd (%)		
UFV (per kg)		1.01	Fish		
PDIA (g/kg)		63	DE (MJ/kg)		
PDIN (g/kg)		187	Ed (%)		
PDIE (g/kg)		118	Nd (%)		
ME (kcal/kg)		12.0			
Ed (%)		81			
OMd (%)		82			
Nd (%)		76			
TId (%)		85			
FAd (%)		73			
Absorbed phosphorus (g/kg)		5.5			
<i>Ruminal degradation</i>	<i>Nitrogen</i>	<i>Starch</i>	<i>DM</i>		
Effective degradability	77	94	73		
a (%)	58		56		
b (%)	35		36		
c (%/h)	7.5		5.5		

Amino acid content and digestibility

Amino acids	Total		Pigs				Poultry		Ruminants
	g/kg	% CP	AID	AIDC	SID	SIDC	TD	TDC	AADI
			%	g/kg	%	g/kg	%	g/kg	% PDIE
LYS	5.7	2.0	63	3.6	66	3.8			5.6
THR	9.9	3.4	77	7.6	80	7.9			5.0
MET	5.2	1.8	85	4.4	86	4.5			2.0
CYS	4.4	1.5	80	3.5	82	3.6			
MET+CYS	9.7	3.3	82	7.9	84	8.1			
TRP	4.2	1.5	79	3.3	81	3.4			
ILE	9.5	3.3	81	7.7	83	7.9			5.0
VAL	10.3	3.6	78	8.1	80	8.3			5.3
LEU	13.7	4.7	84	11.5	85	11.7			7.5
PHE	13.6	4.7	88	12.0	90	12.2			5.4
TYR	7.8	2.7	86	6.7	88	6.9			
PHE+TYR	21.4	7.4	87	18.7	89	19.1			
HIS	5.9	2.0	78	4.6	80	4.7			2.1
ARG	13.0	4.5	86	11.2	88	11.5			4.8
ALA	9.5	3.3	75	7.2	78	7.5			
ASP	11.5	4.0	74	8.6	77	8.9			
GLU	72.9	25.2	89	65.0	90	65.5			
GLY	10.3	3.6	76	7.8	80	8.3			
SER	11.5	4.0	83	9.5	84	9.7			
PRO	18.3	6.3							

Wheat gluten feed, starch 25%

Dried by-product from the manufacture of wheat starch by wet milling, containing about 25% starch (as fed) (n = 910).

All values are expressed on an as fed basis unless otherwise noted.

Main constituents	mean	sd	Fatty acids	%FA	g/kg
Dry matter (%)	90.6	1.0	Myristic acid C14:0	0.1	0.0
Crude protein (%)	14.7	1.1	Palmitic acid C16:0	17.8	4.6
Crude fibre (%)	5.6	0.7	Palmitoleic acid C16:1	0.4	0.1
Ether extract (%)	4.0	0.6	Stearic acid C18:0	0.8	0.2
Ash (%)	7.4	0.9	Oleic acid C18:1	15.2	3.9
Neutral detergent fibre (%)	28.3		Linoleic acid C18:2	56.4	14.6
Acid detergent fibre (%)	8.2		Linolenic acid C18:3	5.9	1.5
Acid detergent lignin (%)	2.7		Eicosenoic acid C20:1	1.3	0.3
Water insoluble cell walls (%)	26.8				
Starch (%)	24.8	3.2	Fatty acids/ether extract (%)	65	
Total sugars (%)	2.7	0.8			
Gross energy (MJ/kg)	16.8				

Mineral elements	mean	sd
Calcium (g/kg)	1.2	0.3
Phosphorus (g/kg)	7.4	0.9
Phytate P / total P (%)	65	
Magnesium (g/kg)	2.9	2.5
Potassium (g/kg)	9.2	3.7
Sodium (g/kg)	16.4	
Chlorine (g/kg)	8.4	2.7
Sulphur (mg/kg)	3.0	
DCAD (mEq/kg)	523	
EB (mEq/kg)	708	
Manganese (mg/kg)	83	
Zinc (mg/kg)	62	
Copper (mg/kg)	7	

Other	mean
Phytase activity (U/kg)	10

Pigs	Growing	Sow	Poultry	Cockerel	Broiler
DE (MJ/kg)	12.2	12.8	AMEn (MJ/kg)	9.2	9.0
ME (MJ/kg)	11.6	12.0	P availability (%)		
NE (MJ/kg)	8.2	8.6	Horses		
Ed (%)	72	76	UFC (per kg)	0.85	
OMd (%)	76	79	MADC (g/kg)	115	
Nd (%)	75	81	Rabbits		
NSId (%)		68	DE (MJ/kg)		
EEEd (%)		52	MEEn (MJ/kg)		
Pd (%)		28	Ed (%)		
			Nd (%)		
Ruminants			Fish		
UFL (per kg)		0.95	DE (MJ/kg)		
UFV (per kg)		0.93	Ed (%)		
PDIA (g/kg)		33	Nd (%)		
PDIN (g/kg)		96			
PDIE (g/kg)		87			
ME (kcal/kg)		10.9			
Ed (%)		79			
OMd (%)		81			
Nd (%)		71			
TId (%)		85			
FAd (%)		72			
Absorbed phosphorus (g/kg)		5.0			
Ruminal degradation	Nitrogen	Starch	DM		
Effective degradability	76	94	70		
a (%)					
b (%)					
c (%/h)					

Amino acid content and digestibility

Amino acids	Total		Pigs				Poultry		Ruminants
	g/kg	% CP	AID	AIDC	SID	SIDC	TD	TDC	AADI
			%	g/kg	%	g/kg	%	g/kg	% PDIE
LYS	5.0	3.4	52	2.6	57	2.9			6.6
THR	5.0	3.4	62	3.1	67	3.4			5.0
MET	2.3	1.5	70	1.6	72	1.6			1.9
CYS	3.1	2.1	68	2.1	72	2.2			
MET+CYS	5.4	3.7	69	3.7	72	3.9			
TRP	1.9	1.3	61	1.2	66	1.2			
ILE	4.9	3.3	67	3.3	70	3.5			5.1
VAL	7.4	5.0	63	4.6	66	4.9			5.8
LEU	9.4	6.4	70	6.6	73	6.9			8.0
PHE	5.8	4.0	74	4.3	78	4.5			4.9
TYR	3.9	2.7	73	2.9	78	3.1			
PHE+TYR	9.8	6.6	74	7.2	78	7.6			
HIS	4.2	2.8	70	2.9	73	3.1			2.2
ARG	9.0	6.1	77	7.0	80	7.2			5.0
ALA	7.1	4.8	58	4.1	62	4.4			
ASP	9.8	6.7	63	6.2	67	6.6			
GLU	29.9	20.3	81	24.2	83	24.7			
GLY	7.4	5.0	57	4.2	63	4.7			
SER	7.0	4.8	69	4.8	72	5.1			
PRO	9.3	6.3							

Wheat gluten feed, starch 28%

Dried by-product from the manufacture of wheat starch by wet milling, containing about 28% starch (as fed) (n = 933).

All values are expressed on an as fed basis unless otherwise noted.

Main constituents	mean	sd	Fatty acids	%FA	g/kg
Dry matter (%)	87.9	0.8	Myristic acid C14:0	0.1	0.0
Crude protein (%)	14.5	0.7	Palmitic acid C16:0	17.8	3.3
Crude fibre (%)	6.1	0.4	Palmitoleic acid C16:1	0.4	0.1
Ether extract (%)	2.8	0.3	Stearic acid C18:0	0.8	0.1
Ash (%)	4.1	0.4	Oleic acid C18:1	15.2	2.8
Insoluble ash (%)	0.3		Linoleic acid C18:2	56.4	10.4
Neutral detergent fibre (%)	28.5	2.6	Linolenic acid C18:3	5.9	1.1
Acid detergent fibre (%)	8.4	0.8	Eicosenoic acid C20:1	1.3	0.2
Acid detergent lignin (%)	2.7	0.5			
Water insoluble cell walls (%)	27.1	1.2	Fatty acids/ether extract (%)	65	
Starch (%)	27.9	2.0			
Total sugars (%)	5.5				
Gross energy (MJ/kg)	16.7				

Mineral elements	mean	sd
Calcium (g/kg)	1.6	0.8
Phosphorus (g/kg)	7.5	0.8
Phytate P / total P (%)	65	
Magnesium (g/kg)	2.3	
Potassium (g/kg)	11.3	
Sodium (g/kg)	0.9	0.7
Chlorine (g/kg)	1.9	
EB (mEq/kg)	275	
Manganese (mg/kg)	81	
Zinc (mg/kg)	61	
Copper (mg/kg)	7	

Other	mean
Phytase activity (U/kg)	10

Pigs	Growing	Sow	Poultry	Cockerel	Broiler
DE (MJ/kg)	11.7	12.4	AMEn (MJ/kg)	9.1	8.9
ME (MJ/kg)	11.2	11.7	P availability (%)		
NE (MJ/kg)	8.0	8.4	Horses		
Ed (%)	70	74	UFC (per kg)	0.86	
OMd (%)	73	77	MADC (g/kg)	113	
Nd (%)	73	80	Rabbits		
NSId (%)		68	DE (MJ/kg)	12.1	
EEd (%)		40	MEEn (MJ/kg)	11.6	
Pd (%)		28	Ed (%)	72	
Ruminants			Nd (%)	76	
UFL (per kg)		0.94	Fish		
UFV (per kg)		0.91	DE (MJ/kg)		
PDIA (g/kg)		33	Ed (%)		
PDIN (g/kg)		94	Nd (%)		
PDIE (g/kg)		86			
ME (kcal/kg)		10.7			
Ed (%)		78			
OMd (%)		80			
Nd (%)		70			
TId (%)		85			
FAd (%)		69			
Absorbed phosphorus (g/kg)		5.1			
Ruminal degradation	Nitrogen	Starch	DM		
Effective degradability	76	94	70		
a (%)					
b (%)					
c (%/h)					

Amino acid content and digestibility

Amino acids	Total		Pigs				Poultry		Ruminants
	g/kg	% CP	AID	AIDC	SID	SIDC	TD	TDC	AADI
			%	g/kg	%	g/kg	%	g/kg	% PDIE
LYS	4.9	3.4	52	2.6	57	2.8			6.6
THR	4.9	3.4	62	3.0	67	3.3			5.0
MET	2.2	1.5	70	1.5	72	1.6			1.9
CYS	3.1	2.1	68	2.1	72	2.2			
MET+CYS	5.3	3.7	69	3.6	72	3.8			
TRP	1.9	1.3	61	1.1	66	1.2			
ILE	4.8	3.3	67	3.2	70	3.4			5.1
VAL	7.2	5.0	63	4.5	66	4.8			5.8
LEU	9.2	6.4	70	6.4	73	6.7			8.0
PHE	5.7	4.0	74	4.3	78	4.4			4.9
TYR	3.9	2.7	73	2.8	78	3.0			
PHE+TYR	5.3	3.7	74	3.9	78	4.1			
HIS	4.1	2.8	70	2.9	73	3.0			2.2
ARG	8.9	6.1	77	6.8	80	7.1			5.0
ALA	7.0	4.8	58	4.1	62	4.3			
ASP	9.6	6.7	63	6.1	67	6.5			
GLU	29.4	20.3	81	23.7	83	24.3			
GLY	7.3	5.0	57	4.1	63	4.6			
SER	6.9	4.8	69	4.7	72	5.0			
PRO	9.2	6.3							

Corn distillers

Dried by-product from maize distillation. It is composed of spent grains and steepwater solubles in variable proportions (n = 1606).

All values are expressed on an as fed basis unless otherwise noted.

Main constituents	mean	sd	Fatty acids	%FA	g/kg
Dry matter (%)	88.2	1.3	Myristic acid C14:0	0.1	0.0
Crude protein (%)	24.6	1.6	Palmitic acid C16:0	11.1	4.3
Crude fibre (%)	7.3	0.6	Palmitoleic acid C16:1	0.4	0.2
Ether extract (%)	3.9	1.0	Stearic acid C18:0	1.8	0.7
Ether extract (hydrolysis) (%)	5.1	0.7	Oleic acid C18:1	26.9	10.3
Ash (%)	6.0	0.4	Linoleic acid C18:2	56.5	21.6
Neutral detergent fibre (%)	31.4	5.2	Linolenic acid C18:3	1.0	0.4
Acid detergent fibre (%)	9.0	3.5			
Acid detergent lignin (%)	1.6	1.2	Fatty acids/ether extract (%)	75	
Water insoluble cell walls (%)	32.4				
Starch (%)	11.5	2.3			
Total sugars (%)	0.5	0.5			
Gross energy (MJ/kg)	17.1	1.0			

Mineral elements	mean	sd	Vitamins	mean
Calcium (g/kg)	2.1	1.2	Vitamin A (1000 UI/kg)	0.90
Phosphorus (g/kg)	8.4	0.7	Vitamin D (1000 UI/kg)	0.53
Phytate P / total P (%)	25		Vitamin E (mg/kg)	38
Magnesium (g/kg)	2.9		Vitamin B1 - thiamin (mg/kg)	3
Potassium (g/kg)	12.4	2.3	Vitamin B2 - riboflavin (mg/kg)	8
Sodium (g/kg)	5.4	2.0	Vitamin B6 - pyridoxine (mg/kg)	7
Chlorine (g/kg)	3.2	0.6	Vitamin B12 (µg/kg)	13
Sulphur (mg/kg)	3.2		Niacin (mg/kg)	73
DCAD (mEq/kg)	261		Pantothenic acid (mg/kg)	13
EB (mEq/kg)	460		Folic acid (mg/kg)	0.85
Manganese (mg/kg)	19		Biotin (mg/kg)	0.63
Zinc (mg/kg)	65		Choline (%)	2221
Copper (mg/kg)	10			
Iron (mg/kg)	105			
Selenium (mg/kg)	0.34			
Cobalt (mg/kg)	0.10			
Molybdenum (mg/kg)	1.7			
Iodine (mg/kg)	0.03			
			Other	mean
			Xanthophylls (mg/kg)	34
			Phytase activity (UI/kg)	340

Pigs	Growing	Sow	Poultry	Cockerel	Broiler
DE (MJ/kg)	11.3	13.1	AMEn (MJ/kg)	9.2	9.1
ME (MJ/kg)	10.5	12.0	P availability (%)		
NE (MJ/kg)	7.0	8.1	Horses		
Ed (%)	66	76	UFC (per kg)		
OMd (%)	69	79	MADC (g/kg)		
Nd (%)	62	72	Rabbits		
NSId (%)		62	DE (MJ/kg)	12.4	
EEd (%)		58	MEEn (MJ/kg)	11.6	
Pd (%)		31	Ed (%)	73	
Ruminants			Nd (%)	70	
UFL (per kg)		0.97	Fish		
UFV (per kg)		0.94	DE (MJ/kg)		
PDIA (g/kg)		108	Ed (%)		
PDIN (g/kg)		181	Nd (%)		
PDIE (g/kg)		154			
ME (kcal/kg)		11.1			
Ed (%)		81			
OMd (%)		82			
Nd (%)		76			
TId (%)		90			
FAd (%)		74			
Absorbed phosphorus (g/kg)		5.7			
<i>Ruminal degradation</i>	<i>Nitrogen</i>	<i>Starch</i>	<i>DM</i>		
Effective degradability	56	85	65		
a (%)	25		40		
b (%)	60		49		
c (%/h)	6.5		6.0		

Amino acid content and digestibility

Amino acids	Total		Pigs				Poultry		Ruminants
	g/kg	% CP	AID	AIDC	SID	SIDC	TD	TDC	AADI
			%	g/kg	%	g/kg	%	g/kg	% PDIE
LYS	6.2	2.5	53	3.3	58	3.6			5.2
THR	8.6	3.5	58	5.0	62	5.3			4.8
MET	4.3	1.7	73	3.1	76	3.3			1.9
CYS	4.8	1.9	56	2.7	59	2.8			
MET+CYS	9.0	3.7	64	5.7	67	6.0			
TRP	1.7	0.7	13	0.2	28	0.5			
ILE	8.1	3.3	69	5.6	72	5.9			4.8
VAL	11.6	4.7	63	7.3	66	7.7			5.7
LEU	24.5	9.9	76	18.7	78	19.2			10.4
PHE	10.3	4.2	76	7.9	79	8.2			5.0
TYR	6.2	2.5	73	4.5	76	4.7			
PHE+TYR	16.5	6.7	75	12.3	78	12.8			
HIS	6.7	2.7	57	3.8	59	3.9			2.5
ARG	10.1	4.1	73	7.3	76	7.6			4.6
ALA	15.1	6.1	64	9.7	67	10.1			
ASP	13.9	5.6	55	7.7	59	8.2			
GLU	38.3	15.5	67	25.6	69	26.4			
GLY	10.0	4.1	42	4.2	46	4.6			
SER	10.6	4.3	63	6.7	66	7.0			
PRO	21.1	8.6							

Corn gluten feed

Dried by-product from the manufacture of maize starch by wet milling. It is composed of bran and gluten, to which the steeping liquor and germs, deoiled or not, may be added (n = 2609).

All values are expressed on an as fed basis unless otherwise noted.

Main constituents	mean	sd	Fatty acids	%FA	g/kg
Dry matter (%)	88.0	1.3	Myristic acid C14:0	0.1	0.0
Crude protein (%)	19.3	1.3	Palmitic acid C16:0	11.1	2.7
Crude fibre (%)	7.5	0.8	Palmitoleic acid C16:1	0.4	0.1
Ether extract (%)	2.7	0.7	Stearic acid C18:0	1.8	0.4
Ash (%)	6.1	1.2	Oleic acid C18:1	26.9	6.6
Insoluble ash (%)	1.5	0.8	Linoleic acid C18:2	56.5	13.9
Neutral detergent fibre (%)	33.8	4.7	Linolenic acid C18:3	1.0	0.2
Acid detergent fibre (%)	8.8	1.3			
Acid detergent lignin (%)	1.1	0.5	Fatty acids/ether extract (%)	90	
Water insoluble cell walls (%)	32.8	2.7			
Starch (%)	18.0	2.7			
Total sugars (%)	1.7	1.2			
Gross energy (MJ/kg)	16.4	0.3			

Mineral elements	mean	sd	Vitamins	mean
Calcium (g/kg)	1.6	0.9	Vitamin A (1000 UI/kg)	3
Phosphorus (g/kg)	8.9	1.5	Vitamin E (mg/kg)	10
Phytate P / total P (%)	65		Vitamin B1 - thiamin (mg/kg)	2
Magnesium (g/kg)	3.4	0.4	Vitamin B2 - riboflavin (mg/kg)	2
Potassium (g/kg)	12.0	1.8	Vitamin B6 - pyridoxine (mg/kg)	13
Sodium (g/kg)	2.3	2.6	Vitamin B12 (µg/kg)	0
Chlorine (g/kg)	2.0	0.6	Niacin (mg/kg)	65
Sulphur (mg/kg)	2.8		Pantothenic acid (mg/kg)	17
DCAD (mEq/kg)	176		Folic acid (mg/kg)	0.27
EB (mEq/kg)	349		Biotin (mg/kg)	0.14
Manganese (mg/kg)	18	7	Choline (%)	1485
Zinc (mg/kg)	53	15		
Copper (mg/kg)	5	4		
Iron (mg/kg)	218	191		
Selenium (mg/kg)	0.21			
Cobalt (mg/kg)	0.15			
Molybdenum (mg/kg)	1.6			
Iodine (mg/kg)	0.12			

Other	mean
Xanthophylls (mg/kg)	14
Phytase activity (UI/kg)	3

Pigs	Growing	Sow	Poultry	Cockerel	Broiler
DE (MJ/kg)	10.8	12.6	AMEn (MJ/kg)	7.7	7.5
ME (MJ/kg)	10.2	11.6	P availability (%)		
NE (MJ/kg)	6.8	8.0	Horses		
Ed (%)	66	76	UFC (per kg)	0.73	
OMd (%)	69	79	MADC (g/kg)	154	
Nd (%)	60	74	Rabbits		
NSId (%)		69	DE (MJ/kg)	11.2	
EEd (%)		35	MEEn (MJ/kg)	10.5	
Pd (%)		22	Ed (%)	68	
Ruminants			Nd (%)	70	
UFL (per kg)		0.93	Fish		
UFV (per kg)		0.91	DE (MJ/kg)	4.8	
PDIA (g/kg)		49	Ed (%)	29	
PDIN (g/kg)		127	Nd (%)	92	
PDIE (g/kg)		102	Pd (%)		
ME (kcal/kg)		10.7			
Ed (%)		80			
OMd (%)		82			
Nd (%)		74			
TId (%)		85			
FAd (%)		72			
Absorbed phosphorus (g/kg)		6.0			
<i>Ruminal degradation</i>	<i>Nitrogen</i>	<i>Starch</i>	<i>DM</i>		
Effective degradability	73	85	60		
a (%)	49	56	33		
b (%)	43	44	60		
c (%/h)	8.0	11.5	5.0		

Amino acid content and digestibility

Amino acids	Total		Pigs				Poultry		Ruminants
	g/kg	% CP	AID	AIDC	SID	SIDC	TD	TDC	AADI
			%	g/kg	%	g/kg	%	g/kg	% PDIE
LYS	5.8	3.0	62	3.6	66	3.8	71	4.1	6.3
THR	6.6	3.4	66	4.3	70	4.6	75	4.9	5.0
MET	3.3	1.7	82	2.7	84	2.8	84	2.8	2.0
CYS	3.8	2.0	66	2.5	69	2.6	64	2.4	
MET+CYS	7.0	3.6	74	5.2	76	5.4	73	5.2	
TRP	1.2	0.6	57	0.7	66	0.8			
ILE	5.9	3.1	74	4.4	78	4.6	82	4.9	5.0
VAL	8.9	4.6	72	6.4	75	6.7	82	7.3	5.8
LEU	15.6	8.1	82	12.8	84	13.1	89	13.9	9.0
PHE	6.8	3.5	81	5.5	84	5.7	86	5.8	4.7
TYR	4.6	2.4	79	3.7	83	3.8			
PHE+TYR	11.4	5.9	80	9.1	83	9.5			
HIS	5.6	2.9	68	3.8	70	3.9	83	4.6	2.4
ARG	8.9	4.6	83	7.4	86	7.6	88	7.8	4.8
ALA	12.4	6.4	78	9.6	80	9.9			
ASP	10.7	5.6	66	7.1	70	7.5			
GLU	27.4	14.2	77	21.0	79	21.6			
GLY	8.1	4.2	60	4.8	65	5.2			
SER	8.0	4.1	74	5.9	77	6.1			
PRO	16.2	8.4	72	11.6	75	12.1			

Corn gluten meal

Dried by-product from the manufacture of maize starch by wet milling. It consists principally of gluten obtained during the separation of starch (n = 757).

All values are expressed on an as fed basis unless otherwise noted.

Main constituents	mean	sd	Fatty acids	%FA	g/kg
Dry matter (%)	89.5	1.5	Myristic acid C14:0	0.1	0.1
Crude protein (%)	60.6	2.9	Palmitic acid C16:0	11.1	5.6
Crude fibre (%)	1.1	0.5	Palmitoleic acid C16:1	0.4	0.2
Ether extract (%)	2.5	1.5	Stearic acid C18:0	1.8	0.9
Ether extract (hydrolysis) (%)	6.3	1.1	Oleic acid C18:1	26.9	13.6
Ash (%)	1.8	1.1	Linoleic acid C18:2	56.5	28.6
Insoluble ash (%)	0.1		Linolenic acid C18:3	1.0	0.5
Neutral detergent fibre (%)	2.3	1.8			
Acid detergent fibre (%)	0.7	0.8	Fatty acids/ether extract (%)	80	
Acid detergent lignin (%)	0.2	0.2			
Water insoluble cell walls (%)	3.4				
Starch (%)	17.2	2.5			
Total sugars (%)	0.3	0.3			
Gross energy (MJ/kg)	20.6	0.8			

Mineral elements	mean	sd	Vitamins	mean
Calcium (g/kg)	0.7	0.5	Vitamin A (1000 UI/kg)	14
Phosphorus (g/kg)	4.9	1.5	Vitamin E (mg/kg)	24
Phytate P / total P (%)	80		Vitamin B1 - thiamin (mg/kg)	0.30
Magnesium (g/kg)	0.4	0.2	Vitamin B2 - riboflavin (mg/kg)	2
Potassium (g/kg)	0.9	0.5	Vitamin B6 - pyridoxine (mg/kg)	8
Sodium (g/kg)	0.9	0.8	Vitamin B12 (µg/kg)	0
Chlorine (g/kg)	0.7	0.1	Niacin (mg/kg)	59
Sulphur (mg/kg)	5.8		Pantothenic acid (mg/kg)	6
DCAD (mEq/kg)	-320		Folic acid (mg/kg)	0.22
EB (mEq/kg)	43		Biotin (mg/kg)	0.18
Manganese (mg/kg)	8	4	Choline (%)	357
Zinc (mg/kg)	33	16		
Copper (mg/kg)	11	4		
Iron (mg/kg)	100	58		
Selenium (mg/kg)	0.20	0.10		
Cobalt (mg/kg)	2			
Molybdenum (mg/kg)	0.82			
			Other	mean
			Xanthophylls (mg/kg)	288

Pigs	Growing	Sow	Poultry	Cockerel	Broiler
DE (MJ/kg)	19.4	19.8	AMEn (MJ/kg)	15.0	14.9
ME (MJ/kg)	17.9	18.2	P availability (%)		
NE (MJ/kg)	11.5	11.8			
Ed (%)	94	96	Horses		
OMd (%)	94	96	UFC (per kg)	0.84	
Nd (%)	87	88	MADC (g/kg)	545	
NSId (%)		92			
EEEd (%)		71	Rabbits		
Pd (%)		19	DE (MJ/kg)		
			MEEn (MJ/kg)		
Ruminants			Ed (%)		
UFL (per kg)		1.32	Nd (%)		
UFV (per kg)		1.32			
PDIA (g/kg)		429	Fish		
PDIN (g/kg)		503	DE (MJ/kg)	17.7	
PDIE (g/kg)		460	DE extruded (MJ/kg)		
ME (kcal/kg)		14.7	Ed (%)	86	
Ed (%)		98	Nd (%)	94	
OMd (%)		96	Pd (%)	9	
Nd (%)		81			
TId (%)		90			
FAd (%)		76			
Absorbed phosphorus (g/kg)		3.3			
<i>Ruminal degradation</i>	<i>Nitrogen</i>	<i>Starch</i>	<i>DM</i>		
Effective degradability	29	87	37		
a (%)	3	23	16		
b (%)	83	77	84		
c (%/h)	2.5	28.5	2.0		

Amino acid content and digestibility

Amino acids	Total		Pigs				Poultry		Ruminants
	g/kg	% CP	AID	AIDC	SID	SIDC	TD	TDC	AADI % PDIE
LYS	10.7	1.8	86	9.2	89	9.5	90	9.6	3.5
THR	20.3	3.4	91	18.5	92	18.8	93	18.9	4.2
MET	14.6	2.4	94	13.7	95	13.8	98	14.3	2.0
CYS	10.8	1.8	91	9.8	92	9.9	94	10.2	
MET+CYS	25.4	4.2	93	23.5	94	23.7	96	24.4	
TRP	2.8	0.5	83	2.4	87	2.5			
ILE	24.8	4.1	92	22.7	92	22.9	96	23.8	4.6
VAL	27.9	4.6	90	25.2	91	25.5	96	26.8	4.9
LEU	96.6	16.0	94	91.2	95	91.5	98	94.7	13.8
PHE	37.6	6.2	94	35.1	94	35.3	98	36.8	5.9
TYR	30.3	5.0	94	28.4	94	28.5	97	29.4	
PHE+TYR	67.8	11.2	94	63.5	94	63.9	98	66.2	
HIS	12.5	2.1	91	11.4	92	11.5	96	12.0	2.1
ARG	19.4	3.2	93	18.1	95	18.4	97	18.9	4.0
ALA	52.9	8.7	92	48.6	93	49.0	98	51.8	
ASP	36.1	6.0	91	32.9	93	33.4	95	34.3	
GLU	125.6	20.7	93	116.5	93	117.	98	123.	
GLY	16.5	2.7	81	13.4	84	13.9	89	14.7	
SER	30.8	5.1	94	28.9	95	29.1	96	29.6	
PRO	53.2	8.8	79	41.7	79	42.2	97	51.6	

Maize bran

By-product from the manufacture of maize flour or semolina. It consists principally of outer skins and some maize germ fragments, with some endosperm particles (n = 348).

All values are expressed on an as fed basis unless otherwise noted.

Main constituents	mean	sd	Fatty acids	%FA	g/kg
Dry matter (%)	87.8	1.6	Myristic acid C14:0	0.1	0.0
Crude protein (%)	10.8	2.3	Palmitic acid C16:0	11.1	3.4
Crude fibre (%)	12.8	3.6	Palmitoleic acid C16:1	0.4	0.1
Ether extract (%)	3.6	1.3	Stearic acid C18:0	1.8	0.6
Ash (%)	6.0	2.1	Oleic acid C18:1	26.9	8.3
Insoluble ash (%)	1.2	1.2	Linoleic acid C18:2	56.5	17.3
Neutral detergent fibre (%)	52.2	6.9	Linolenic acid C18:3	1.0	0.3
Acid detergent fibre (%)	14.6	4.1			
Acid detergent lignin (%)	2.3	0.9	Fatty acids/ether extract (%)	85	
Water insoluble cell walls (%)	54.1				
Starch (%)	29.9	9.0			
Total sugars (%)	2.2	0.7			
Gross energy (MJ/kg)	16.6	0.5			

Mineral elements	mean	sd
Calcium (g/kg)	4.7	2.4
Phosphorus (g/kg)	2.9	0.6
Phytate P / total P (%)	75	
Magnesium (g/kg)	1.4	
Potassium (g/kg)	8.8	
Sodium (g/kg)	0.3	
Chlorine (g/kg)	2.1	
Sulphur (mg/kg)	1.1	
DCAD (mEq/kg)	113	
EB (mEq/kg)	179	
Manganese (mg/kg)	19	
Copper (mg/kg)	2	
Iron (mg/kg)	26	
Selenium (mg/kg)	0.15	

Pigs	Growing	Sow	Poultry	Cockerel	Broiler
DE (MJ/kg)	7.5	10.3	AMEn (MJ/kg)		
ME (MJ/kg)	7.2	9.8	P availability (%)		
NE (MJ/kg)	5.4	7.1	Horses		
Ed (%)	45	63	UFC (per kg)	0.76	
OMd (%)	50	67	MADC (g/kg)	87	
Nd (%)	42	80	Rabbits		
EEd (%)		36	DE (MJ/kg)		
Pd (%)		20	MEEn (MJ/kg)		
Ruminants			Ed (%)		
UFL (per kg)		0.78	Nd (%)		
UFV (per kg)		0.73	Fish		
PDIA (g/kg)		55	DE (MJ/kg)		
PDIN (g/kg)		78	Ed (%)		
PDIE (g/kg)		91	Nd (%)		
ME (kcal/kg)		9.3			
Ed (%)		68			
OMd (%)		70			
Nd (%)		62			
TId (%)		80			
FAd (%)		73			
Absorbed phosphorus (g/kg)		2.2			
Ruminal degradation	Nitrogen	Starch	DM		
Effective degradability	43	60	40		
a (%)					
b (%)					
c (%/h)					

Amino acid content and digestibility

Amino acids	Total		Pigs				Poultry		Ruminants
	g/kg	% CP	AID %	AIDC g/kg	SID %	SIDC g/kg	TD %	TDC g/kg	AADI % PDIE
LYS	4.1	3.7							6.3
THR	3.7	3.4							4.9
MET	1.8	1.7							1.9
CYS	2.3	2.2							
MET+CYS	4.2	3.9							
TRP	0.6	0.6							
ILE	2.9	2.7							4.7
VAL	4.9	4.5							5.7
LEU	10.1	9.3							10.0
PHE	2.6	2.4							3.8
TYR	2.4	2.2							
PHE+TYR	5.0	4.6							
HIS	3.4	3.1							2.7
ARG	6.5	5.9							5.3
ALA	7.6	7.0							
ASP	6.3	5.8							
GLU	13.1	12.1							
GLY	4.9	4.5							
SER	4.2	3.9							
PRO	8.8	8.1							

Maize feed flour

By-product from the manufacture of maize flour or semolina. It consists principally of particles of endosperm with fragments of germs and of the outer skins (n = 158).

All values are expressed on an as fed basis unless otherwise noted.

Main constituents	mean	sd	Fatty acids	%FA	g/kg
Dry matter (%)	87.3	1.3	Myristic acid C14:0	0.1	0.0
Crude protein (%)	9.0	1.2	Palmitic acid C16:0	11.1	5.1
Crude fibre (%)	5.8	1.6	Palmitoleic acid C16:1	0.4	0.2
Ether extract (%)	5.4	1.3	Stearic acid C18:0	1.8	0.8
Ash (%)	2.3	1.3	Oleic acid C18:1	26.9	12.3
Insoluble ash (%)	0.1		Linoleic acid C18:2	56.5	25.8
Neutral detergent fibre (%)	25.6	6.4	Linolenic acid C18:3	1.0	0.5
Acid detergent fibre (%)	6.9	2.6			
Acid detergent lignin (%)	1.1	1.3	Fatty acids/ether extract (%)	85	
Water insoluble cell walls (%)	28.3				
Starch (%)	45.6	5.5			
Total sugars (%)	2.5	0.9			
Gross energy (MJ/kg)	16.9				

Mineral elements	mean	sd
Calcium (g/kg)	1.3	1.3
Phosphorus (g/kg)	4.6	1.5
Phytate P / total P (%)	75	
Magnesium (g/kg)	1.3	
Potassium (g/kg)	4.6	
Sodium (g/kg)	0.2	
Chlorine (g/kg)	0.8	0.3
Sulphur (mg/kg)	1.0	
DCAD (mEq/kg)	42	
EB (mEq/kg)	105	
Iodine (mg/kg)	0.09	

Pigs	Growing	Sow	Poultry	Cockerel	Broiler
DE (MJ/kg)	12.3	13.7	AMEn (MJ/kg)	11.1	10.9
ME (MJ/kg)	11.9	13.2	P availability (%)		
NE (MJ/kg)	9.3	10.1	Horses		
Ed (%)	73	81	UFC (per kg)	0.94	
OMd (%)	76	84	MADC (g/kg)	54	
Nd (%)	67	90	Rabbits		
EEd (%)		61	DE (MJ/kg)		
Pd (%)		20	MEEn (MJ/kg)		
Ruminants			Ed (%)		
UFL (per kg)		1.06	Nd (%)		
UFV (per kg)		1.06	Fish		
PDIA (g/kg)		48	DE (MJ/kg)		
PDIN (g/kg)		67	Ed (%)		
PDIE (g/kg)		83	Nd (%)		
ME (kcal/kg)		11.8			
Ed (%)		84			
OMd (%)		86			
Nd (%)		67			
TId (%)		85			
FAd (%)		75			
Absorbed phosphorus (g/kg)		3.5			
Ruminal degradation	Nitrogen	Starch	DM		
Effective degradability	43	60	55		
a (%)					
b (%)					
c (%/h)					

Amino acid content and digestibility

Amino acids	Total		Pigs				Poultry		Ruminants
	g/kg	% CP	AID %	AIDC g/kg	SID %	SIDC g/kg	TD %	TDC g/kg	AADI % PDIE
LYS	3.7	4.1							6.3
THR	3.4	3.8							5.0
MET	1.6	1.8							1.9
CYS	2.0	2.2							
MET+CYS	3.6	4.0							
TRP	0.5	0.5							
ILE	3.0	3.3							4.9
VAL	4.4	5.0							5.7
LEU	8.8	9.8							9.6
PHE	3.7	4.1							4.8
TYR	2.6	2.9							
PHE+TYR	6.3	7.0							
HIS	2.6	2.9							2.4
ARG	4.6	5.1							4.8
ALA	6.2	6.9							
ASP	6.5	7.3							
GLU	13.9	15.5							
GLY	4.0	4.4							
SER	4.0	4.5							
PRO	7.1	8.0							

Maize germ meal, expeller

By-product from the manufacture of maize oil. It consists of mechanically extracted germs to which parts of the endosperm and outer skins may still adhere (n = 22).

All values are expressed on an as fed basis unless otherwise noted.

Main constituents	mean	sd	Fatty acids	%FA	g/kg
Dry matter (%)	91.5	3.4	Myristic acid C14:0	0.1	0.1
Crude protein (%)	15.1	3.1	Palmitic acid C16:0	11.1	12.1
Crude fibre (%)	6.2	1.8	Palmitoleic acid C16:1	0.4	0.4
Ether extract (%)	13.6	2.8	Stearic acid C18:0	1.8	2.0
Ash (%)	5.4	2.0	Oleic acid C18:1	26.9	29.3
Neutral detergent fibre (%)	29.0	11.8	Linoleic acid C18:2	56.5	61.6
Acid detergent fibre (%)	7.5		Linolenic acid C18:3	1.0	1.1
Acid detergent lignin (%)	2.0				
Water insoluble cell walls (%)	30.0		Fatty acids/ether extract (%)	80	
Starch (%)	29.5	7.1			
Total sugars (%)	0.7				
Gross energy (MJ/kg)	19.0	1.0			

Mineral elements	mean	sd
Calcium (g/kg)	0.4	
Phosphorus (g/kg)	8.4	
Phytate P / total P (%)	75	
Magnesium (g/kg)	2.9	
Potassium (g/kg)	1.4	
Chlorine (g/kg)	1.2	
Sulphur (mg/kg)	2.2	
Manganese (mg/kg)	12	
Copper (mg/kg)	13	
Iron (mg/kg)	218	

Pigs	Growing	Sow	Poultry	Cockerel	Broiler
DE (MJ/kg)	14.3	14.8	AMEn (MJ/kg)	11.2	10.8
ME (MJ/kg)	13.7	14.1	P availability (%)		
NE (MJ/kg)	10.5	10.9	Horses		
Ed (%)	75	78	UFC (per kg)	0.87	
OMd (%)	78	81	MADC (g/kg)	113	
Nd (%)	71	76	Rabbits		
EEd (%)		73	DE (MJ/kg)		
Pd (%)		20	MEEn (MJ/kg)		
Ruminants			Ed (%)		
UFL (per kg)		1.18	Nd (%)		
UFV (per kg)		1.18	Fish		
PDIA (g/kg)		41	DE (MJ/kg)		
PDIN (g/kg)		101	Ed (%)		
PDIE (g/kg)		83	Nd (%)		
ME (kcal/kg)		13.2			
Ed (%)		85			
OMd (%)		85			
Nd (%)		73			
TId (%)		88			
FAd (%)		77			
Absorbed phosphorus (g/kg)		5.7			
<i>Ruminal degradation</i>	<i>Nitrogen</i>	<i>Starch</i>	<i>DM</i>		
Effective degradability	72	67	52		
a (%)			6		
b (%)			83		
c (%/h)			7.5		

Amino acid content and digestibility

Amino acids	Total		Pigs				Poultry		Ruminants
	g/kg	% CP	AID %	AIDC g/kg	SID %	SIDC g/kg	TD %	TDC g/kg	AADI % PDIE
LYS	5.0	3.3							6.3
THR	5.3	3.5							5.0
MET	2.6	1.7							1.9
CYS	3.1	2.0							
MET+CYS	5.7	3.8							
TRP	0.9	0.6							
ILE	4.8	3.1							5.0
VAL	7.1	4.7							5.8
LEU	13.0	8.6							9.2
PHE	5.5	3.7							4.7
TYR	3.8	2.5							
PHE+TYR	9.4	6.2							
HIS	4.4	2.9							2.4
ARG	7.7	5.1							4.9
ALA	10.0	6.6							
ASP	9.1	6.0							
GLU	22.1	14.6							
GLY	6.4	4.3							
SER	6.4	4.2							
PRO	12.6	8.3							

Maize germ meal, solvent extracted

By-product from the manufacture of maize oil. It consists of solvent extracted germs to which parts of the endosperm and outer skins may still adhere (n = 418).

All values are expressed on an as fed basis unless otherwise noted.

Main constituents	mean	sd	Fatty acids	%FA	g/kg
Dry matter (%)	87.4	1.7	Myristic acid C14:0	0.1	0.0
Crude protein (%)	25.8	1.5	Palmitic acid C16:0	11.1	2.1
Crude fibre (%)	8.8	0.9	Palmitoleic acid C16:1	0.4	0.1
Ether extract (%)	2.5	0.8	Stearic acid C18:0	1.8	0.3
Ash (%)	3.1	1.0	Oleic acid C18:1	26.9	5.1
Neutral detergent fibre (%)	37.1		Linoleic acid C18:2	56.5	10.6
Acid detergent fibre (%)	10.4		Linolenic acid C18:3	1.0	0.2
Acid detergent lignin (%)	1.5				
Water insoluble cell walls (%)	36.1		Fatty acids/ether extract (%)	75	
Starch (%)	13.6	2.3			
Total sugars (%)	0.5				
Gross energy (MJ/kg)	17.0				

Mineral elements	mean	sd	Vitamins	mean
Calcium (g/kg)	0.4	0.2	Vitamin A (1000 UI/kg)	0.90
Phosphorus (g/kg)	6.3	1.7	Vitamin E (mg/kg)	82
Phytate P / total P (%)	75			
Magnesium (g/kg)	2.7			
Potassium (g/kg)	3.4			
Sodium (g/kg)	0.4			
Sulphur (mg/kg)	2.2			
Manganese (mg/kg)	17			
Zinc (mg/kg)	131			
Copper (mg/kg)	12			
Iron (mg/kg)	749			
Selenium (mg/kg)	0.50			
Cobalt (mg/kg)	0.25			

Pigs	Growing	Sow	Poultry	Cockerel	Broiler
DE (MJ/kg)	12.5	13.1	AMEn (MJ/kg)	7.3	7.2
ME (MJ/kg)	11.7	12.0	P availability (%)		
NE (MJ/kg)	7.5	7.9	Horses		
Ed (%)	74	77	UFC (per kg)	0.72	
OMd (%)	76	80	MADC (g/kg)	206	
Nd (%)	71	74	Rabbits		
NSId (%)		68	DE (MJ/kg)		
EEEd (%)		28	MEEn (MJ/kg)		
Pd (%)		20	Ed (%)		
			Nd (%)		
Ruminants			Fish		
UFL (per kg)		0.92	DE (MJ/kg)		
UFV (per kg)		0.89	Ed (%)		
PDIA (g/kg)		121	Nd (%)		
PDIN (g/kg)		190			
PDIE (g/kg)		159			
ME (kcal/kg)		10.6			
Ed (%)		79			
OMd (%)		79			
Nd (%)		75			
TId (%)		88			
FAd (%)		69			
Absorbed phosphorus (g/kg)		4.3			
<i>Ruminal degradation</i>	<i>Nitrogen</i>	<i>Starch</i>	<i>DM</i>		
Effective degradability	52	67	52		
a (%)	3		6		
b (%)	90		83		
c (%/h)	7.0		7.5		

Amino acid content and digestibility

Amino acids	Total		Pigs				Poultry		Ruminants
	g/kg	% CP	AID	AIDC	SID	SIDC	TD	TDC	AADI
			%	g/kg	%	g/kg	%	g/kg	% PDIE
LYS	6.9	2.7	59	4.1	61	4.2			5.3
THR	8.5	3.3	68	5.8	71	6.0			4.8
MET	4.3	1.7	80	3.4	81	3.4			1.9
CYS	4.9	1.9	64	3.1	67	3.3			
MET+CYS	9.2	3.6	72	6.6	74	6.8			
TRP	1.8	0.7	68	1.2	71	1.3			
ILE	7.8	3.0	73	5.6	74	5.8			4.7
VAL	11.7	4.5	70	8.1	72	8.3			5.8
LEU	19.9	7.7	75	14.9	76	15.2			9.5
PHE	8.7	3.4	79	6.8	81	7.0			4.5
TYR	5.8	2.3	76	4.5	78	4.6			
PHE+TYR	14.5	5.6	78	11.3	80	11.5			
HIS	7.4	2.9	83	6.2	84	6.2			2.8
ARG	10.3	4.0	83	8.6	84	8.7			4.8
ALA	16.2	6.3	69	11.2	71	11.5			
ASP	13.3	5.2	58	7.7	60	8.0			
GLU	35.9	13.9	74	26.4	75	27.0			
GLY	10.7	4.1	59	6.3	63	6.7			
SER	10.4	4.0	73	7.6	75	7.8			
PRO	22.1	8.6							

Hominy feed

By-product from the manufacture of maize semolina. It consists of deoiled germs to which parts of the endosperm and outer skins may still adhere (n = 138).

All values are expressed on an as fed basis unless otherwise noted.

Main constituents	mean	sd	Fatty acids	%FA	g/kg
Dry matter (%)	89.4	1.1	Fatty acids/ether extract (%)	80	
Crude protein (%)	13.4	1.1			
Crude fibre (%)	5.5	1.1			
Ether extract (%)	6.1	0.6			
Ash (%)	4.7	1.2			
Neutral detergent fibre (%)	26.7				
Acid detergent fibre (%)	6.7				
Acid detergent lignin (%)	1.3				
Water insoluble cell walls (%)	28.0				
Starch (%)	36.1	3.1			
Total sugars (%)	2.7				
Gross energy (MJ/kg)	17.0				

Mineral elements	mean	sd	Vitamins	mean
Calcium (g/kg)	1.4		Vitamin A (1000 UI/kg)	5
Phosphorus (g/kg)	7.7	2.1	Vitamin E (mg/kg)	6
Phytate P / total P (%)	70		Vitamin B1 - thiamin (mg/kg)	8
Magnesium (g/kg)	2.6		Vitamin B2 - riboflavin (mg/kg)	2
Potassium (g/kg)	6.9		Vitamin B6 - pyridoxine (mg/kg)	11
Sodium (g/kg)	0.6		Vitamin B12 (µg/kg)	0
Chlorine (g/kg)	1.0		Niacin (mg/kg)	47
Sulphur (mg/kg)	1.0		Pantothenic acid (mg/kg)	8
DCAD (mEq/kg)	110		Folic acid (mg/kg)	0.21
EB (mEq/kg)	174		Biotin (mg/kg)	0.13
Manganese (mg/kg)	21		Choline (%)	1147
Zinc (mg/kg)	45			
Copper (mg/kg)	7			
Iron (mg/kg)	140			
Selenium (mg/kg)	0.10			
Molybdenum (mg/kg)	1.1			

Pigs	Growing	Sow	Poultry	Cockerel	Broiler
DE (MJ/kg)	12.6	13.9	AMEn (MJ/kg)	10.1	9.8
ME (MJ/kg)	12.1	13.3	P availability (%)		
NE (MJ/kg)	9.1	10.0	Horses		
Ed (%)	74	82	UFC (per kg)	0.91	
OMd (%)	77	85	MADC (g/kg)	93	
Nd (%)	68	82	Rabbits		
NSId (%)		72	DE (MJ/kg)		
EEEd (%)		63	MEEn (MJ/kg)		
Pd (%)		21	Ed (%)		
			Nd (%)		
Ruminants			Fish		
UFL (per kg)		1.06	DE (MJ/kg)		
UFV (per kg)		1.06	Ed (%)		
PDIA (g/kg)		37	Nd (%)		
PDIN (g/kg)		90			
PDIE (g/kg)		84			
ME (kcal/kg)		11.9			
Ed (%)		85			
OMd (%)		87			
Nd (%)		72			
TId (%)		88			
FAd (%)		75			
Absorbed phosphorus (g/kg)		5.2			
<i>Ruminal degradation</i>	<i>Nitrogen</i>	<i>Starch</i>	<i>DM</i>		
Effective degradability	72	67	52		
a (%)	36	39	6		
b (%)	59	61	83		
c (%/h)	9.5	5.0	7.5		

Amino acid content and digestibility

Amino acids	Total		Pigs				Poultry		Ruminants
	g/kg	% CP	AID	AIDC	SID	SIDC	TD	TDC	AADI
			%	g/kg	%	g/kg	%	g/kg	% PDIE
LYS	4.6	3.4	60	2.7	65	3.0			6.5
THR	4.8	3.6	60	2.8	65	3.1			5.1
MET	2.3	1.8	85	2.0	86	2.0			2.0
CYS	2.8	2.1	64	1.8	67	1.9			
MET+CYS	5.1	3.8	75	3.8	77	3.9			
TRP	0.8	0.6	52	0.4	60	0.5			
ILE	4.2	3.2	72	3.0	75	3.2			5.1
VAL	6.3	4.7	70	4.4	73	4.7			5.8
LEU	11.8	8.8	81	9.5	83	9.7			9.1
PHE	5.0	3.7	81	4.0	84	4.2			4.8
TYR	3.5	2.6	84	2.9	88	3.1			
PHE+TYR	8.5	6.3	82	7.0	85	7.2			
HIS	3.8	2.9	71	2.7	74	2.8			2.3
ARG	6.8	5.1	83	5.7	86	5.9			4.9
ALA	8.9	6.6	77	6.8	79	7.0			
ASP	8.4	6.3	67	5.6	72	6.0			
GLU	19.7	14.7	78	15.4	80	15.8			
GLY	5.7	4.3	55	3.1	62	3.5			
SER	5.7	4.3	72	4.1	76	4.3			
PRO	11.0	8.3							

Barley rootlets, dried

Dried by-product from brewing consisting of barley rootlets and germs (n = 184).

Synonym: malt culms.

All values are expressed on an as fed basis unless otherwise noted.

Main constituents	mean	sd	Fatty acids	%FA	g/kg
Dry matter (%)	89.3	1.8	Myristic acid C14:0	1.2	0.1
Crude protein (%)	21.8	3.1	Palmitic acid C16:0	22.2	1.8
Crude fibre (%)	12.7	1.5	Stearic acid C18:0	1.5	0.1
Ether extract (%)	1.8	0.5	Oleic acid C18:1	12.0	1.0
Ash (%)	5.6	0.6	Linoleic acid C18:2	55.4	4.6
Neutral detergent fibre (%)	39.9	5.0	Linolenic acid C18:3	5.6	0.5
Acid detergent fibre (%)	15.0	1.9			
Acid detergent lignin (%)	2.6	0.5	Fatty acids/ether extract (%)	45	
Starch (%)	11.3	4.4			
Total sugars (%)	6.6				
Gross energy (MJ/kg)	16.5	0.5			

Mineral elements	mean	sd
Calcium (g/kg)	2.9	1.1
Phosphorus (g/kg)	5.5	0.9
Phytate P / total P (%)	25	
Magnesium (g/kg)	1.5	
Potassium (g/kg)	13.4	
Sodium (g/kg)	0.3	
Chlorine (g/kg)	3.6	
Sulphur (mg/kg)	3.3	
DCAD (mEq/kg)	49	
EB (mEq/kg)	257	
Manganese (mg/kg)	55	
Zinc (mg/kg)	78	
Copper (mg/kg)	10	
Iron (mg/kg)	278	
Selenium (mg/kg)	0.59	
Cobalt (mg/kg)	0.10	
Molybdenum (mg/kg)	1.1	

Pigs	Growing	Sow	Poultry	Cockerel	Broiler
DE (MJ/kg)	9.9	10.7	AMEn (MJ/kg)		
ME (MJ/kg)	9.2	9.8	P availability (%)		
NE (MJ/kg)	5.9	6.4			
Ed (%)	60	65	Horses		
OMd (%)	63	68	UFC (per kg)	0.72	
Nd (%)	74	79	MADC (g/kg)	181	
EEd (%)		5			
Ruminants			Rabbits		
UFL (per kg)		0.70	DE (MJ/kg)	10.7	
UFV (per kg)		0.63	MEEn (MJ/kg)	9.9	
PDIA (g/kg)		45	Ed (%)	65	
PDIN (g/kg)		135	Nd (%)	75	
PDIE (g/kg)		88			
ME (kcal/kg)		8.5	Fish		
Ed (%)		64	DE (MJ/kg)		
OMd (%)		66	Ed (%)		
Nd (%)		70	Nd (%)		
TId (%)		72			
FAd (%)		57			
Absorbed phosphorus (g/kg)		4.3			
<i>Ruminal degradation</i>	<i>Nitrogen</i>	<i>Starch</i>	<i>DM</i>		
Effective degradability	74	95	64		
a (%)	50		42		
b (%)	40		48		
c (%/h)	8.5		5.0		

Amino acid content and digestibility

Amino acids	Total		Pigs				Poultry		Ruminants
	g/kg	% CP	AID %	AIDC g/kg	SID %	SIDC g/kg	TD %	TDC g/kg	AADI % PDIE
LYS	9.7	4.4							6.6
THR	6.8	3.1							4.8
MET	3.3	1.5							1.8
CYS	3.9	1.8							
MET+CYS	7.2	3.3							
TRP	2.5	1.1							
ILE	7.9	3.6							5.0
VAL	10.2	4.7							5.6
LEU	15.5	7.1							8.2
PHE	11.5	5.3							5.4
TYR	6.9	3.1							
PHE+TYR	18.4	8.4							
HIS	4.2	1.9							2.0
ARG	9.0	4.1							4.6
ALA	9.1	4.2							
ASP	11.9	5.5							
GLU	50.4	23.1							
GLY	7.4	3.4							
SER	9.0	4.1							
PRO	22.3	10.2							

Brewers' dried grains

Dried by-product from brewing consisting of spent barley grains (n = 68).

All values are expressed on an as fed basis unless otherwise noted.

Main constituents	mean	sd	Fatty acids	%FA	g/kg
Dry matter (%)	91.9	2.2	Myristic acid C14:0	1.2	0.4
Crude protein (%)	24.1	3.4	Palmitic acid C16:0	22.2	7.4
Crude fibre (%)	15.3	2.7	Stearic acid C18:0	1.5	0.5
Ether extract (%)	6.7	2.3	Oleic acid C18:1	12.0	4.0
Ether extract (hydrolysis) (%)	7.4	1.2	Linoleic acid C18:2	55.4	18.5
Ash (%)	3.9	0.6	Linolenic acid C18:3	5.6	1.9
Insoluble ash (%)	1.6				
Neutral detergent fibre (%)	52.8	6.7	Fatty acids/ether extract (%)	45	
Acid detergent fibre (%)	20.4	3.5			
Acid detergent lignin (%)	5.4	2.4			
Starch (%)	6.9				
Total sugars (%)	0.9	0.2			
Gross energy (MJ/kg)	18.8				

Mineral elements	mean	sd	Vitamins	mean
Calcium (g/kg)	2.1	1.3	Vitamin A (1000 UI/kg)	0
Phosphorus (g/kg)	5.8	0.8	Vitamin E (mg/kg)	28
Phytate P / total P (%)	60		Vitamin B1 - thiamin (mg/kg)	0.64
Magnesium (g/kg)	2.4	0.5	Vitamin B2 - riboflavin (mg/kg)	1.3
Potassium (g/kg)	3.4	1.3	Vitamin B6 - pyridoxine (mg/kg)	0.80
Sodium (g/kg)	0.3	0.1	Vitamin B12 (µg/kg)	4
Chlorine (g/kg)	1.0	0.3	Niacin (mg/kg)	43
Sulphur (mg/kg)	2.8		Pantothenic acid (mg/kg)	9
DCAD (mEq/kg)	-102		Folic acid (mg/kg)	5
EB (mEq/kg)	70		Biotin (mg/kg)	0.32
Manganese (mg/kg)	43	11	Choline (%)	1646
Zinc (mg/kg)	82	28		
Copper (mg/kg)	18	5		
Iron (mg/kg)	120	21		
Selenium (mg/kg)	0.38			
Cobalt (mg/kg)	0.09			
Molybdenum (mg/kg)	1.3			

Pigs	Growing	Sow	Poultry	Cockerel	Broiler
DE (MJ/kg)	9.9	10.8	AMEn (MJ/kg)	8.6	8.4
ME (MJ/kg)	9.1	9.9	P availability (%)		
NE (MJ/kg)	6.2	6.7	Horses		
Ed (%)	52	58	UFC (per kg)		
OMd (%)	56	61	MADC (g/kg)		
Nd (%)	77	83	Rabbits		
NSId (%)		78	DE (MJ/kg)		
EEEd (%)		59	MEEn (MJ/kg)		
Pd (%)		32	Ed (%)		
			Nd (%)		
Ruminants			Fish		
UFL (per kg)		0.76	DE (MJ/kg)		
UFV (per kg)		0.67	Ed (%)		
PDIA (g/kg)		126	Nd (%)		
PDIN (g/kg)		178			
PDIE (g/kg)		157			
ME (kcal/kg)		9.2			
Ed (%)		62			
OMd (%)		61			
Nd (%)		70			
TId (%)		84			
FAd (%)		73			
Absorbed phosphorus (g/kg)		4.5			
<i>Ruminal degradation</i>	<i>Nitrogen</i>	<i>Starch</i>	<i>DM</i>		
Effective degradability	44	83	36		
a (%)	18	77	12		
b (%)	57	23	57		
c (%/h)	5.0	2.5	4.5		

Amino acid content and digestibility

Amino acids	Total		Pigs				Poultry		Ruminants
	g/kg	% CP	AID	AIDC	SID	SIDC	TD	TDC	AADI
			%	g/kg	%	g/kg	%	g/kg	% PDIE
LYS	7.7	3.2	79	6.1	82	6.3			5.2
THR	7.4	3.1	78	5.8	81	6.0			4.4
MET	3.6	1.5	87	3.1	89	3.2			1.6
CYS	4.2	1.7	75	3.1	77	3.2			
MET+CYS	7.8	3.2	81	6.3	83	6.5			
TRP	2.8	1.1	80	2.2	83	2.3			
ILE	8.8	3.6	87	7.6	89	7.8			4.8
VAL	11.2	4.7	83	9.4	86	9.6			5.4
LEU	17.2	7.1	86	14.8	88	15.1			8.4
PHE	12.7	5.3	90	11.4	91	11.6			5.7
TYR	7.6	3.2	92	7.0	94	7.2			
PHE+TYR	20.4	8.5	90	18.4	92	18.8			
HIS	4.5	1.9	82	3.7	85	3.8			2.1
ARG	9.8	4.1	93	9.1	95	9.3			4.5
ALA	10.1	4.2	79	7.9	81	8.2			
ASP	13.1	5.4	76	10.0	80	10.4			
GLU	55.6	23.1	88	49.2	90	49.8			
GLY	8.1	3.3	75	6.0	80	6.4			
SER	9.9	4.1	83	8.3	86	8.6			
PRO	24.6	10.2							

Rice bran, extracted

By-product from the manufacture of rice oil. It is a mixture of deoiled germs, endosperm fragments and outer skins (n = 120).

All values are expressed on an as fed basis unless otherwise noted.

Main constituents	mean	sd	Fatty acids	%FA	g/kg
Dry matter (%)	90.2	1.2	Lauric acid C12:0	0.1	0.0
Crude protein (%)	14.4	1.3	Myristic acid C14:0	0.7	0.2
Crude fibre (%)	9.3	1.1	Palmitic acid C16:0	18.1	3.9
Ether extract (%)	3.1	1.0	Palmitoleic acid C16:1	0.3	0.1
Ash (%)	11.5	1.2	Stearic acid C18:0	1.9	0.4
Insoluble ash (%)	1.5	0.9	Oleic acid C18:1	40.2	8.7
Neutral detergent fibre (%)	24.1	4.5	Linoleic acid C18:2	35.9	7.7
Acid detergent fibre (%)	11.3	1.7	Linolenic acid C18:3	1.5	0.3
Acid detergent lignin (%)	3.9	0.6	Arachidic acid C20:0	0.2	0.0
Water insoluble cell walls (%)	25.5				
Starch (%)	30.2	1.9	Fatty acids/ether extract (%)	70	
Total sugars (%)	2.3				
Gross energy (MJ/kg)	15.9				

Mineral elements	mean	sd	Vitamins	mean
Calcium (g/kg)	2.2	1.6	Vitamin E (mg/kg)	60
Phosphorus (g/kg)	17.7	3.0	Vitamin B1 - thiamin (mg/kg)	22
Phytate P / total P (%)	85		Vitamin B2 - riboflavin (mg/kg)	3
Magnesium (g/kg)	8.1		Vitamin B6 - pyridoxine (mg/kg)	29
Potassium (g/kg)	11.1		Niacin (mg/kg)	281
Sodium (g/kg)	0.2		Pantothenic acid (mg/kg)	23
Chlorine (g/kg)	1.0		Folic acid (mg/kg)	2
Sulphur (mg/kg)	1.5		Biotin (mg/kg)	0.42
DCAD (mEq/kg)	170		Choline (%)	1118
EB (mEq/kg)	264			
Manganese (mg/kg)	267			
Zinc (mg/kg)	73			
Copper (mg/kg)	14			
Iron (mg/kg)	268			
Selenium (mg/kg)	0.15			
Iodine (mg/kg)	0.32			

Pigs	Growing	Sow	Poultry	Cockerel	Broiler
DE (MJ/kg)	9.2	10.3	AMEn (MJ/kg)	8.7	8.5
ME (MJ/kg)	8.8	9.7	P availability (%)		
NE (MJ/kg)	6.5	7.0	Horses		
Ed (%)	58	65	UFC (per kg)	0.84	
OMd (%)	62	68	MADC (g/kg)	113	
Nd (%)	57	67	Rabbits		
EEd (%)		46	DE (MJ/kg)		
Pd (%)		12	MEEn (MJ/kg)		
Ruminants			Ed (%)		
UFL (per kg)		0.69	Nd (%)		
UFV (per kg)		0.62	Fish		
PDIA (g/kg)		65	DE (MJ/kg)		
PDIN (g/kg)		101	Ed (%)		
PDIE (g/kg)		97	Nd (%)		
ME (kcal/kg)		8.3			
Ed (%)		64			
OMd (%)		68			
Nd (%)		65			
TId (%)		80			
FAd (%)		70			
Absorbed phosphorus (g/kg)		11.3			
<i>Ruminal degradation</i>	<i>Nitrogen</i>	<i>Starch</i>	<i>DM</i>		
Effective degradability	49	73	66		
a (%)	11		48		
b (%)	76		35		
c (%/h)	6.0		6.5		

Amino acid content and digestibility

Amino acids	Total		Pigs				Poultry		Ruminants
	g/kg	% CP	AID %	AIDC g/kg	SID %	SIDC g/kg	TD %	TDC g/kg	AADI % PDIE
LYS	6.5	4.5					72	4.7	6.4
THR	5.4	3.7					67	3.6	4.9
MET	3.1	2.2					76	2.4	2.1
CYS	3.1	2.1					64	2.0	
MET+CYS	6.2	4.3					70	4.4	
TRP	1.9	1.3							
ILE	5.2	3.6					68	3.6	5.0
VAL	7.6	5.3					71	5.4	5.9
LEU	10.2	7.1					70	7.2	8.4
PHE	6.6	4.6					70	4.6	5.2
TYR	2.6	1.8					80	2.1	
PHE+TYR	9.2	6.4					73	6.7	
HIS	3.7	2.6					83	3.1	2.4
ARG	11.6	8.0					86	10.0	5.9
ALA	8.5	5.9							
ASP	12.5	8.7							
GLU	20.0	13.9							
GLY	7.0	4.9							
SER	6.7	4.6							
PRO	6.5	4.5							

Rice bran, full fat

By-product from the manufacture of rice oil. It is a mixture of outer skins, endosperm fragments and germs (n = 108).

All values are expressed on an as fed basis unless otherwise noted.

Main constituents	mean	sd	Fatty acids	%FA	g/kg
Dry matter (%)	90.1	1.5	Lauric acid C12:0	0.1	0.1
Crude protein (%)	13.8	1.5	Myristic acid C14:0	0.7	0.9
Crude fibre (%)	7.8	1.6	Palmitic acid C16:0	18.1	23.8
Ether extract (%)	16.4	3.5	Palmitoleic acid C16:1	0.3	0.4
Ash (%)	8.2	1.8	Stearic acid C18:0	1.9	2.5
Insoluble ash (%)	0.7	0.4	Oleic acid C18:1	40.2	52.8
Neutral detergent fibre (%)	20.5	3.2	Linoleic acid C18:2	35.9	47.1
Acid detergent fibre (%)	8.9	1.9	Linolenic acid C18:3	1.5	2.0
Acid detergent lignin (%)	3.2	0.8	Arachidic acid C20:0	0.2	0.3
Water insoluble cell walls (%)	23.8				
Starch (%)	27.4	7.1	Fatty acids/ether extract (%)	80	
Total sugars (%)	2.9				
Gross energy (MJ/kg)	19.4	0.5			

Mineral elements	mean	sd	Vitamins	mean
Calcium (g/kg)	0.8	0.6	Vitamin E (mg/kg)	35
Phosphorus (g/kg)	16.1	2.1	Vitamin B1 - thiamin (mg/kg)	23
Phytate P / total P (%)	85		Vitamin B2 - riboflavin (mg/kg)	3
Magnesium (g/kg)	6.6	0.6	Vitamin B6 - pyridoxine (mg/kg)	26
Potassium (g/kg)	13.5	1.3	Vitamin B12 (µg/kg)	0
Sodium (g/kg)	0.4	0.9	Niacin (mg/kg)	293
Chlorine (g/kg)	0.8	0.2	Pantothenic acid (mg/kg)	23
Sulphur (mg/kg)	1.7		Folic acid (mg/kg)	2
DCAD (mEq/kg)	236		Biotin (mg/kg)	0.35
EB (mEq/kg)	341		Choline (%)	1137
Manganese (mg/kg)	211	59		
Zinc (mg/kg)	60	22		
Copper (mg/kg)	7	4		
Iron (mg/kg)	109	73		
Selenium (mg/kg)	0.16	0.08		
Cobalt (mg/kg)	0.21			
Molybdenum (mg/kg)	1.6			
			Other	mean
			Phytase activity (U/kg)	120

Pigs	Growing	Sow	Poultry	Cockerel	Broiler
DE (MJ/kg)	12.5	13.4	AMEn (MJ/kg)	11.9	11.5
ME (MJ/kg)	12.1	12.9	P availability (%)		
NE (MJ/kg)	9.8	10.2	Horses		
Ed (%)	65	69	UFC (per kg)	0.96	
OMd (%)	68	73	MADC (g/kg)	114	
Nd (%)	57	66	Rabbits		
NSId (%)		66	DE (MJ/kg)	12.4	
EEEd (%)		76	MEEn (MJ/kg)	12.0	
Pd (%)		12	Ed (%)	64	
Ruminants			Nd (%)	65	
UFL (per kg)		0.92	Fish		
UFV (per kg)		0.86	DE (MJ/kg)		
PDIA (g/kg)		39	Ed (%)		
PDIN (g/kg)		90	Nd (%)		
PDIE (g/kg)		66			
ME (kcal/kg)		10.9			
Ed (%)		69			
OMd (%)		70			
Nd (%)		64			
TId (%)		80			
FAd (%)		78			
Absorbed phosphorus (g/kg)		10.3			
<i>Ruminal degradation</i>	<i>Nitrogen</i>	<i>Starch</i>	<i>DM</i>		
Effective degradability	68	73	66		
a (%)	42	19	48		
b (%)	41	81	35		
c (%/h)	10.5	12.0	6.5		

Amino acid content and digestibility

Amino acids	Total		Pigs				Poultry		Ruminants
	g/kg	% CP	AID	AIDC	SID	SIDC	TD	TDC	AADI
			%	g/kg	%	g/kg	%	g/kg	% PDIE
LYS	6.1	4.4	68	4.1	73	4.5	74	4.5	6.5
THR	5.1	3.7	61	3.1	67	3.5	69	3.5	5.0
MET	3.0	2.2	71	2.1	75	2.3	78	2.3	2.1
CYS	3.0	2.2	60	1.8	65	1.9	66	2.0	
MET+CYS	6.0	4.3	65	3.9	70	4.2	72	4.3	
TRP	1.8	1.3	60	1.1	70	1.2			
ILE	5.0	3.6	62	3.1	68	3.4	75	3.8	5.0
VAL	7.4	5.3	62	4.6	68	5.0	76	5.6	5.9
LEU	9.8	7.1	64	6.3	69	6.8	75	7.4	8.4
PHE	6.4	4.6	63	4.0	68	4.3	75	4.8	5.2
TYR	2.1	1.5	68	1.4	74	1.6	80	1.7	
PHE+TYR	8.5	6.2	65	5.5	71	6.0	76	6.5	
HIS	3.5	2.5	80	2.8	83	2.9	81	2.8	2.3
ARG	11.1	8.0	82	9.1	85	9.4	86	9.5	5.8
ALA	8.1	5.9	64	5.2	70	5.6			
ASP	11.9	8.7	66	7.9	71	8.5			
GLU	19.4	14.1	76	14.7	80	15.5			
GLY	6.7	4.9	61	4.1	67	4.5			
SER	6.4	4.6	64	4.1	70	4.5			
PRO	6.2	4.5	54	3.3	62	3.9			

Rice, broken

Broken or small rice grains, obtained after the polishing process (n = 50).

All values are expressed on an as fed basis unless otherwise noted.

Main constituents	mean	sd	Fatty acids	%FA	g/kg
Dry matter (%)	87.4	1.4	Lauric acid C12:0	0.1	0.0
Crude protein (%)	7.7	1.1	Myristic acid C14:0	0.7	0.1
Crude fibre (%)	1.1	1.8	Palmitic acid C16:0	18.1	2.0
Ether extract (%)	1.2	0.9	Palmitoleic acid C16:1	0.3	0.0
Ash (%)	0.9	2.0	Stearic acid C18:0	1.9	0.2
Insoluble ash (%)	0.4		Oleic acid C18:1	40.2	4.5
Neutral detergent fibre (%)	5.2	3.3	Linoleic acid C18:2	35.9	4.0
Acid detergent fibre (%)	1.3	0.6	Linolenic acid C18:3	1.5	0.2
Acid detergent lignin (%)	0.6	0.4	Arachidic acid C20:0	0.2	0.0
Water insoluble cell walls (%)	2.3				
Starch (%)	77.1	2.5	Fatty acids/ether extract (%)	90	
Total sugars (%)	0.4				
Gross energy (MJ/kg)	15.8	0.9			

Mineral elements	mean	sd	Vitamins	mean
Calcium (g/kg)	0.5	0.4	Vitamin E (mg/kg)	2
Phosphorus (g/kg)	2.1	0.9	Vitamin B1 - thiamin (mg/kg)	1.0
Phytate P / total P (%)	55		Vitamin B2 - riboflavin (mg/kg)	0.35
Magnesium (g/kg)	1.5		Vitamin B6 - pyridoxine (mg/kg)	14
Potassium (g/kg)	3.1		Vitamin B12 (µg/kg)	0
Sodium (g/kg)	0.04		Niacin (mg/kg)	19
Chlorine (g/kg)	0.4		Pantothenic acid (mg/kg)	5
Sulphur (mg/kg)	0.8		Folic acid (mg/kg)	0.24
DCAD (mEq/kg)	21		Biotin (mg/kg)	0.05
EB (mEq/kg)	72		Choline (%)	974
Manganese (mg/kg)	14			
Zinc (mg/kg)	16			
Copper (mg/kg)	1.4			
Iron (mg/kg)	44			
Selenium (mg/kg)	0.09			
Cobalt (mg/kg)	0.04			
Molybdenum (mg/kg)	0.80			
Iodine (mg/kg)	0.05			

Pigs	Growing	Sow	Poultry	Cockerel	Broiler
DE (MJ/kg)	14.8	14.9	AMEn (MJ/kg)	14.2	13.9
ME (MJ/kg)	14.5	14.5	P availability (%)		
NE (MJ/kg)	11.8	11.8	Horses		
Ed (%)	94	94	UFC (per kg)	1.16	
OMd (%)	98	98	MADC (g/kg)	61	
Nd (%)	89	90	Rabbits		
EEd (%)		24	DE (MJ/kg)		
Ruminants			ME _n (MJ/kg)		
UFL (per kg)		1.07	Ed (%)		
UFV (per kg)		1.08	Nd (%)		
PDIA (g/kg)		22	Fish		
PDIN (g/kg)		52	DE (MJ/kg)		
PDIE (g/kg)		64	Ed (%)		
ME (kcal/kg)		11.7	Nd (%)		
Ed (%)		88			
OMd (%)		91			
Nd (%)		67			
TId (%)		90			
FAd (%)		63			
Absorbed phosphorus (g/kg)		1.6			
Ruminal degradation	Nitrogen	Starch	DM		
Effective degradability	71	67	70		
a (%)					
b (%)					
c (%/h)					

Amino acid content and digestibility

Amino acids	Total		Pigs				Poultry		Ruminants
	g/kg	% CP	AID %	AIDC g/kg	SID %	SIDC g/kg	TD %	TDC g/kg	AADI % PDIE
LYS	2.8	3.7							6.7
THR	2.6	3.4							5.0
MET	1.8	2.4							2.1
CYS	1.8	2.4							
MET+CYS	3.6	4.7							
TRP	0.9	1.1							
ILE	3.1	4.0							5.3
VAL	4.5	5.9							5.9
LEU	6.0	7.8							8.3
PHE	3.9	5.1							5.2
TYR	3.5	4.5							
PHE+TYR	7.4	9.6							
HIS	1.8	2.3							2.1
ARG	6.3	8.2							5.2
ALA	4.1	5.3							
ASP	6.6	8.6							
GLU	12.8	16.7							
GLY	3.4	4.4							
SER	3.8	4.9							
PRO	3.3	4.2							

Chickpea

Chickpea seed (*Cicer arietinum* L.). The profile corresponds to Kabuli varieties from the Mediterranean area (n = 82).

All values are expressed on an as fed basis unless otherwise noted.

Main constituents	mean	sd	Fatty acids	%FA	g/kg
Dry matter (%)	89.0	1.1	Fatty acids/ether extract (%)	85	
Crude protein (%)	19.9	1.8			
Crude fibre (%)	3.5	0.5			
Ether extract (%)	6.0	1.2			
Ash (%)	3.0	0.2			
Insoluble ash (%)	0.0				
Neutral detergent fibre (%)	9.3	1.6			
Acid detergent fibre (%)	3.7	0.4			
Acid detergent lignin (%)	0.2	0.1			
Water insoluble cell walls (%)	10.5	0.6			
Starch (%)	44.8	1.6			
Total sugars (%)	5.2	1.7			
Gross energy (MJ/kg)	17.5	0.4			

Mineral elements	mean	sd	Vitamins	mean
Calcium (g/kg)	1.1	0.4	Vitamin A (1000 UI/kg)	1
Phosphorus (g/kg)	3.6	0.8	Vitamin K (mg/kg)	3
Phytate P / total P (%)	50		Vitamin B2 - riboflavin (mg/kg)	1.3
Magnesium (g/kg)	1.2	0.1	Vitamin B6 - pyridoxine (mg/kg)	5
Potassium (g/kg)	7.0		Niacin (mg/kg)	16
Sodium (g/kg)	0.4		Pantothenic acid (mg/kg)	13
Chlorine (g/kg)	1.2		Folic acid (mg/kg)	3
EB (mEq/kg)	160		Vitamin C (mg/kg)	48
Manganese (mg/kg)	19			
Zinc (mg/kg)	22			
Copper (mg/kg)	6			
Iron (mg/kg)	55			
Selenium (mg/kg)	0.09			

Pigs	Growing	Sow	Poultry	Cockerel	Broiler
DE (MJ/kg)	15.3	15.8	AMEn (MJ/kg)		
ME (MJ/kg)	14.6	15.1	P availability (%)		
NE (MJ/kg)	11.0	11.3	Horses		
Ed (%)	87	90	UFC (per kg)	0.99	
OMd (%)	89	92	MADC (g/kg)	165	
Nd (%)	80	84	Rabbits		
EEd (%)		69	DE (MJ/kg)		
Ruminants			MEEn (MJ/kg)		
UFL (per kg)		1.19	Ed (%)		
UFV (per kg)		1.21	Nd (%)		
PDIA (g/kg)		42	Fish		
PDIN (g/kg)		130	DE (MJ/kg)		
PDIE (g/kg)		94	Ed (%)		
ME (kcal/kg)		13.1	Nd (%)		
Ed (%)		92			
OMd (%)		93			
Nd (%)		78			
TId (%)		91			
FAd (%)		76			
Absorbed phosphorus (g/kg)		2.6			
<i>Ruminal degradation</i>	<i>Nitrogen</i>	<i>Starch</i>	<i>DM</i>		
Effective degradability	79	79	71		
a (%)	31		30		
b (%)	65		68		
c (%/h)	17.0		9.0		

Amino acid content and digestibility

Amino acids	Total		Pigs				Poultry		Ruminants
	g/kg	% CP	AID %	AIDC g/kg	SID %	SIDC g/kg	TD %	TDC g/kg	AADI % PDIE
LYS	13.5	6.8							7.6
THR	6.8	3.4							4.9
MET	2.2	1.1							1.7
CYS	1.9	0.9							
MET+CYS	4.1	2.0							
TRP	1.7	0.8							
ILE	8.3	4.2							5.3
VAL	8.3	4.2							5.4
LEU	14.6	7.4							8.3
PHE	11.1	5.6							5.5
TYR	4.3	2.2							
PHE+TYR	15.4	7.8							
HIS	5.1	2.6							2.2
ARG	17.7	8.9							5.6
ALA	7.5	3.8							
ASP	21.4	10.8							
GLU	37.4	18.8							
GLY	6.9	3.5							
SER	9.6	4.8							
PRO	8.4	4.2							

Cottonseed, full fat

Cotton seed (*Gossypium* spp.) (n = 41).

Extruded cottonseed for ruminants: see page 292

All values are expressed on an as fed basis unless otherwise noted.

Main constituents	mean	sd	Fatty acids	%FA	g/kg
Dry matter (%)	90.6	1.8	Lauric acid C12:0	0.5	0.9
Crude protein (%)	21.2	2.1	Myristic acid C14:0	0.9	1.6
Crude fibre (%)	23.4	3.7	Palmitic acid C16:0	23.0	41.8
Ether extract (%)	19.1	2.5	Palmitoleic acid C16:1	0.9	1.6
Ash (%)	3.9	0.4	Stearic acid C18:0	2.4	4.4
Insoluble ash (%)	0.1	0.0	Oleic acid C18:1	17.5	31.8
Neutral detergent fibre (%)	38.3	3.6	Linoleic acid C18:2	52.3	95.0
Acid detergent fibre (%)	29.6	3.5	Linolenic acid C18:3	0.2	0.4
Acid detergent lignin (%)	8.4	2.9			
Water insoluble cell walls (%)	45.5		Fatty acids/ether extract (%)	95	
Starch (%)	0.0				
Total sugars (%)	1.5				
Gross energy (MJ/kg)	21.8				

Mineral elements	mean	sd
Calcium (g/kg)	1.6	0.3
Phosphorus (g/kg)	6.3	0.8
Phytate P / total P (%)	80	
Magnesium (g/kg)	3.2	0.2
Potassium (g/kg)	10.5	1.0
Sodium (g/kg)	0.1	0.1
Chlorine (g/kg)	0.5	0.2
Sulphur (mg/kg)	2.0	
DCAD (mEq/kg)	138	
EB (mEq/kg)	260	
Manganese (mg/kg)	14	1.0
Zinc (mg/kg)	34	3
Copper (mg/kg)	10	1.0
Iron (mg/kg)	63	32
Selenium (mg/kg)	0.13	
Cobalt (mg/kg)	0.38	
Molybdenum (mg/kg)	1.5	

Pigs			Growing	Sow	Poultry		Cockerel	Broiler
DE (MJ/kg)			13.4	14.3	AMEn (MJ/kg)			
ME (MJ/kg)			12.7	13.4	P availability (%)			
NE (MJ/kg)			9.0	9.5				
Ed (%)			61	66	Horses			
OMd (%)			63	68	UFC (per kg)			
Nd (%)			62	69	MADC (g/kg)			
EEd (%)				80				
Ruminants					Rabbits			
UFL (per kg)			0.94		DE (MJ/kg)			
UFV (per kg)			0.85		MEEn (MJ/kg)			
PDIA (g/kg)			48		Ed (%)			
PDIN (g/kg)			131		Nd (%)			
PDIE (g/kg)			77		Fish			
ME (kcal/kg)			11.3		DE (MJ/kg)			
Ed (%)			66		Ed (%)			
OMd (%)			64		Nd (%)			
Nd (%)			71					
TId (%)			71					
FAd (%)			78					
Absorbed phosphorus (g/kg)			4.6					
<i>Ruminal degradation</i>	<i>Nitrogen</i>	<i>Starch</i>		<i>DM</i>				
Effective degradability			71					
a (%)			36					
b (%)			43					
c (%/h)			26.0					

Amino acid content and digestibility

Amino acids	Total		Pigs				Poultry		Ruminants
	g/kg	% CP	AID %	AIDC g/kg	SID %	SIDC g/kg	TD %	TDC g/kg	AADI % PDIE
LYS	9.5	4.5							6.6
THR	7.5	3.5							4.9
MET	3.6	1.7							1.9
CYS	3.2	1.5							
MET+CYS	6.8	3.2							
TRP	2.8	1.3							
ILE	5.9	2.8							4.7
VAL	8.1	3.8							5.3
LEU	11.1	5.2							7.5
PHE	10.2	4.8							5.5
TYR	5.5	2.6							
PHE+TYR	15.7	7.4							
HIS	6.9	3.3							2.7
ARG	19.1	9.0							6.2
ALA	7.0	3.3							
ASP	19.4	9.2							
GLU	36.7	17.3							
GLY	7.4	3.5							
SER	9.5	4.5							
PRO	8.8	4.1							

Faba bean, coloured flowers

Faba bean (*Vicia faba* L. minor or equina) from high-tannin, coloured-flowered varieties (n = 154).

Synonyms: field bean, broad bean, horse bean.

Extruded faba bean and toasted faba bean for ruminants: see page 292

All values are expressed on an as fed basis unless otherwise noted.

Main constituents	mean	sd	Fatty acids	%FA	g/kg
Dry matter (%)	86.5	2.0	Myristic acid C14:0	0.4	0.0
Crude protein (%)	25.4	2.2	Palmitic acid C16:0	16.9	1.8
Crude fibre (%)	7.9	1.1	Stearic acid C18:0	2.6	0.3
Ether extract (%)	1.3	0.3	Oleic acid C18:1	26.0	2.8
Ash (%)	3.3	0.4	Linoleic acid C18:2	49.6	5.3
Neutral detergent fibre (%)	13.9	2.6	Linolenic acid C18:3	3.5	0.4
Acid detergent fibre (%)	9.2	1.0	Fatty acids/ether extract (%)	80	
Acid detergent lignin (%)	0.8	0.6			
Water insoluble cell walls (%)	15.4	1.2			
Starch (%)	38.3	2.7			
Total sugars (%)	3.0	0.8			
Gross energy (MJ/kg)	16.2	0.5			

Mineral elements	mean	sd	Vitamins	mean
Calcium (g/kg)	1.4	0.5	Vitamin E (mg/kg)	5
Phosphorus (g/kg)	4.6	0.6	Vitamin B1 - thiamin (mg/kg)	5
Phytate P / total P (%)	60		Vitamin B2 - riboflavin (mg/kg)	3
Magnesium (g/kg)	1.6	0.3	Vitamin B12 (µg/kg)	0
Potassium (g/kg)	9.8	1.0	Niacin (mg/kg)	25
Sodium (g/kg)	0.1	0.1	Pantothenic acid (mg/kg)	3
Chlorine (g/kg)	0.7		Biotin (mg/kg)	0.09
Sulphur (mg/kg)	2.4		Choline (%)	1661
DCAD (mEq/kg)	88			
EB (mEq/kg)	235			
Manganese (mg/kg)	7	2		
Zinc (mg/kg)	31	6		
Copper (mg/kg)	12	2		
Iron (mg/kg)	59			
Selenium (mg/kg)	0.02			
Cobalt (mg/kg)	0.35			
Molybdenum (mg/kg)	0.63			

Pigs	Growing	Sow	Poultry	Cockerel	Broiler
DE (MJ/kg)	13.5	13.8	AMEn ground (MJ/kg)	9.8	9.5
ME (MJ/kg)	12.7	13.0	AMEn pelleted (MJ/kg)	10.3	10.0
NE (MJ/kg)	9.0	9.2	P availability (%)		
Ed (%)	83	85	Horses		
OMd (%)	85	87	UFC (per kg)	0.97	
Nd (%)	81	83	MADC (g/kg)	211	
NSId (%)		80	Rabbits		
EEd (%)		15	DE (MJ/kg)	12.8	
Pd (%)		37	MEEn (MJ/kg)	11.8	
Ruminants			Ed (%)	79	
UFL (per kg)		1.04	Nd (%)	80	
UFV (per kg)		1.04	Fish		
PDIA (g/kg)		45	DE (MJ/kg)		
PDIN (g/kg)		162	Ed (%)		
PDIE (g/kg)		97	Nd (%)		
ME (kcal/kg)		11.6			
Ed (%)		90			
OMd (%)		91			
Nd (%)		79			
TId (%)		89			
FAd (%)		62			
Absorbed phosphorus (g/kg)		3.4			
<i>Ruminal degradation</i>	<i>Nitrogen</i>	<i>Starch</i>	<i>DM</i>		
Effective degradability	82	75	77		
a (%)	51		52		
b (%)	47		43		
c (%/h)	11.5		8.5		

Amino acid content and digestibility

Amino acids	Total		Pigs				Poultry		Ruminants
	g/kg	% CP	AID	AIDC	SID	SIDC	TD	TDC	AADI
			%	g/kg	%	g/kg	%	g/kg	% PDIE
LYS	16.6	6.5	83	13.7	85	14.0			7.4
THR	9.1	3.6	76	6.9	80	7.2			5.0
MET	1.8	0.7	77	1.4	80	1.5			1.5
CYS	3.2	1.3	69	2.2	73	2.3			
MET+CYS	5.0	2.0	72	3.6	76	3.8			
TRP	2.1	0.8	66	1.4	70	1.5			
ILE	10.3	4.1	80	8.3	82	8.5			5.2
VAL	11.5	4.5	77	8.8	79	9.1			5.5
LEU	19.3	7.6	82	15.9	84	16.2			8.3
PHE	10.7	4.2	81	8.6	83	8.9			4.8
TYR	8.1	3.2	78	6.3	81	6.5			
PHE+TYR	18.8	7.4	80	15.0	82	15.4			
HIS	6.4	2.5	83	5.4	85	5.5			2.2
ARG	24.1	9.5	88	21.1	89	21.4			5.7
ALA	10.5	4.1	78	8.2	78	8.2			
ASP	30.4	12.0	83	25.3	85	25.8			
GLU	44.8	17.6	86	38.4	87	39.0			
GLY	11.0	4.3	70	7.7	74	8.2			
SER	12.9	5.1	80	10.3	82	10.6			
PRO	10.5	4.1	70	7.3	74	7.8			

Faba bean, white flowers

Faba bean (*Vicia faba* L. minor or equina) from low-tannin, white-flowered varieties (n = 30).

Synonyms: field bean, broad bean, horse bean.

Extruded faba bean and toasted faba beans for ruminants: see page 292

All values are expressed on an as fed basis unless otherwise noted.

Main constituents	mean	sd	Fatty acids	%FA	g/kg
Dry matter (%)	86.1	1.9	Myristic acid C14:0	0.4	0.0
Crude protein (%)	26.8	2.2	Palmitic acid C16:0	16.9	1.5
Crude fibre (%)	7.5	0.9	Stearic acid C18:0	2.6	0.2
Ether extract (%)	1.1	0.2	Oleic acid C18:1	26.0	2.3
Ash (%)	3.6	0.3	Linoleic acid C18:2	49.6	4.4
Neutral detergent fibre (%)	13.7	2.3	Linolenic acid C18:3	3.5	0.3
Acid detergent fibre (%)	9.1	1.0	Fatty acids/ether extract (%)	80	
Acid detergent lignin (%)	0.7	0.6			
Water insoluble cell walls (%)	15.3	1.3			
Starch (%)	37.3	2.3			
Total sugars (%)	3.7	0.7			
Gross energy (MJ/kg)	16.1	0.4			

Mineral elements	mean	sd	Vitamins	mean
Calcium (g/kg)	1.4		Vitamin E (mg/kg)	5
Phosphorus (g/kg)	4.7	0.3	Vitamin B1 - thiamin (mg/kg)	5
Phytate P / total P (%)	60		Vitamin B2 - riboflavin (mg/kg)	3
Magnesium (g/kg)	1.7		Vitamin B12 (µg/kg)	0
Potassium (g/kg)	10.0		Niacin (mg/kg)	25
Sodium (g/kg)	0.1		Pantothenic acid (mg/kg)	3
Chlorine (g/kg)	0.7		Biotin (mg/kg)	0.09
Sulphur (mg/kg)	1.8		Choline (%)	1652
DCAD (mEq/kg)	129			
EB (mEq/kg)	240			
Manganese (mg/kg)	7			
Zinc (mg/kg)	31			
Copper (mg/kg)	11			
Iron (mg/kg)	73			
Selenium (mg/kg)	0.02			
Molybdenum (mg/kg)	0.63			

Pigs	Growing	Sow	Poultry	Cockerel	Broiler
DE (MJ/kg)	13.9	14.1	AMEn ground (MJ/kg)	10.4	10.2
ME (MJ/kg)	13.1	13.3	AMEn pelleted (MJ/kg)	11.0	10.8
NE (MJ/kg)	9.2	9.3	P availability (%)		23
Ed (%)	86	88	Horses		
OMd (%)	88	90	UFC (per kg)	0.95	
Nd (%)	83	85	MADC (g/kg)	222	
NSId (%)		84	Rabbits		
EEd (%)		2	DE (MJ/kg)		
Pd (%)		37	MEn (MJ/kg)		
Ruminants			Ed (%)		
UFL (per kg)		1.03	Nd (%)		
UFV (per kg)		1.03	Fish		
PDIA (g/kg)		45	DE (MJ/kg)	9.7	
PDIN (g/kg)		170	DE extruded (MJ/kg)		
PDIE (g/kg)		97	Ed (%)	60	
ME (kcal/kg)		11.5	Nd (%)	80	
Ed (%)		90	Pd (%)		
OMd (%)		91			
Nd (%)		79			
TId (%)		89			
FAd (%)		59			
Absorbed phosphorus (g/kg)		3.4			
<i>Ruminal degradation</i>	<i>Nitrogen</i>	<i>Starch</i>	<i>DM</i>		
Effective degradability	83	75	77		
a (%)	56	37	52		
b (%)	40	63	43		
c (%/h)	11.5	9.0	8.5		

Amino acid content and digestibility

Amino acids	Total		Pigs				Poultry		Ruminants
	g/kg	% CP	AID	AIDC	SID	SIDC	TD	TDC	AADI
			%	g/kg	%	g/kg	%	g/kg	% PDIE
LYS	17.2	6.4	86	14.9	88	15.2	91	15.7	7.4
THR	9.5	3.6	80	7.6	83	7.9	87	8.3	4.9
MET	1.9	0.7	80	1.5	83	1.6	83	1.6	1.5
CYS	3.4	1.3	72	2.4	76	2.6	74	2.5	
MET+CYS	5.3	2.0	75	4.0	79	4.2	77	4.1	
TRP	2.2	0.8	77	1.7	81	1.8			
ILE	10.9	4.1	83	9.0	85	9.3	88	9.6	5.2
VAL	12.1	4.5	80	9.7	82	10.0	87	10.6	5.5
LEU	20.3	7.6	84	17.1	86	17.5	91	18.5	8.3
PHE	11.2	4.2	85	9.5	87	9.7	90	10.1	4.8
TYR	8.5	3.2	81	6.9	84	7.1	87	7.4	
PHE+TYR	19.7	7.4	83	16.5	86	16.9	89	17.5	
HIS	6.8	2.5	88	6.0	90	6.1	90	6.1	2.2
ARG	26.1	9.8	91	23.7	92	24.0	94	24.6	5.7
ALA	11.0	4.1	76	8.3	79	8.7	87	9.6	
ASP	32.2	12.0	85	27.5	87	28.1	90	29.0	
GLU	47.2	17.6	87	41.3	89	42.0	92	43.5	
GLY	11.5	4.3	78	8.9	81	9.3	72	8.3	
SER	13.6	5.1	84	11.4	86	11.7	88	12.0	
PRO	11.1	4.1	77	8.6	81	9.0	87	9.6	

Linseed, full fat

Linseed seed (*Linum usitatissimum* L.) (n = 75).

Extruded linseed for ruminants: see page 292

All values are expressed on an as fed basis unless otherwise noted.

Main constituents	mean	sd	Fatty acids	%FA	g/kg
Dry matter (%)	90.3	2.3	Myristic acid C14:0	0.1	0.3
Crude protein (%)	22.6	2.5	Palmitic acid C16:0	6.4	19.9
Crude fibre (%)	9.2	2.6	Palmitoleic acid C16:1	0.1	0.3
Ether extract (%)	32.7	3.2	Stearic acid C18:0	3.4	10.6
Ash (%)	4.3	0.9	Oleic acid C18:1	18.7	58.0
Neutral detergent fibre (%)	22.1	7.3	Linoleic acid C18:2	14.7	45.6
Acid detergent fibre (%)	13.4	3.7	Linolenic acid C18:3	54.2	168.2
Acid detergent lignin (%)	5.6	2.7			
Starch (%)	0.0		Fatty acids/ether extract (%)	95	
Total sugars (%)	3.4				
Gross energy (MJ/kg)	24.2				

Mineral elements	mean	sd	Vitamins	mean
Calcium (g/kg)	3.8		Vitamin K (mg/kg)	0.05
Phosphorus (g/kg)	6.1		Vitamin B1 - thiamin (mg/kg)	1.6
Phytate P / total P (%)	70		Vitamin B2 - riboflavin (mg/kg)	1.5
Magnesium (g/kg)	3.6		Niacin (mg/kg)	13
Potassium (g/kg)	7.2			
Sodium (g/kg)	0.7			
Chlorine (g/kg)	0.6			
Sulphur (mg/kg)	2.7			
DCAD (mEq/kg)	32			
EB (mEq/kg)	199			
Manganese (mg/kg)	29			
Zinc (mg/kg)	45			
Copper (mg/kg)	12			
Iron (mg/kg)	148			
Molybdenum (mg/kg)	0.20			
Iodine (mg/kg)	0.40			

Pigs	Growing	Sow	Poultry	Cockerel	Broiler
DE (MJ/kg)	17.5	18.2	AMEn (MJ/kg)	14.2	
ME (MJ/kg)	16.8	17.3	P availability (%)		
NE (MJ/kg)	13.1	13.5			
Ed (%)	73	75	Horses		
OMd (%)	74	78	UFC (per kg)	1.08	
Nd (%)	83	87	MADC (g/kg)	181	
EEd (%)		79			
Pd (%)		12	Rabbits		
			DE (MJ/kg)		
Ruminants			MEEn (MJ/kg)		
UFL (per kg)		1.43	Ed (%)		
UFV (per kg)		1.40	Nd (%)		
PDIA (g/kg)		47			
PDIN (g/kg)		145	Fish		
PDIE (g/kg)		76	DE (MJ/kg)		
ME (kcal/kg)		16.2	Ed (%)		
Ed (%)		83	Nd (%)		
OMd (%)		80			
Nd (%)		75			
TId (%)		85			
FAd (%)		79			
Absorbed phosphorus (g/kg)		4.5			
<i>Ruminal degradation</i>	<i>Nitrogen</i>	<i>Starch</i>	<i>DM</i>		
Effective degradability	78		60		
a (%)	54		36		
b (%)	38		38		
c (%/h)	10.5		10.5		

Amino acid content and digestibility

Amino acids	Total		Pigs				Poultry		Ruminants
	g/kg	% CP	AID %	AIDC g/kg	SID %	SIDC g/kg	TD %	TDC g/kg	AADI % PDIE
LYS	8.9	3.9					89	7.9	5.9
THR	10.5	4.6							5.1
MET	4.4	1.9					79	3.5	1.9
CYS	4.4	2.0					80	3.5	
MET+CYS	8.8	3.9					80	7.0	
TRP	3.9	1.7							
ILE	11.1	4.9					86	9.6	5.3
VAL	12.0	5.3					81	9.7	5.6
LEU	15.0	6.6					90	13.5	7.7
PHE	12.8	5.6					88	11.2	5.4
TYR	6.4	2.8							
PHE+TYR	19.1	8.5							
HIS	5.5	2.4					90	4.9	2.2
ARG	24.5	10.8					91	22.3	6.2
ALA	10.3	4.6							
ASP	23.2	10.3							
GLU	43.6	19.3							
GLY	12.5	5.5							
SER	12.2	5.4							
PRO	8.4	3.7							

Lupin, blue

Blue lupin seed (*Lupinus angustifolius* L.) (n = 54).

Toasted blue lupin for ruminants: see page 292

All values are expressed on an as fed basis unless otherwise noted.

Main constituents	mean	sd	Fatty acids	%FA	g/kg
Dry matter (%)	90.2	2.1	Myristic acid C14:0	0.3	0.1
Crude protein (%)	30.7	2.6	Palmitic acid C16:0	6.9	3.3
Crude fibre (%)	14.9	1.8	Palmitoleic acid C16:1	0.1	0.0
Ether extract (%)	5.3	0.8	Stearic acid C18:0	3.6	1.7
Ash (%)	3.4	0.5	Oleic acid C18:1	31.9	15.3
Insoluble ash (%)	0.1		Linoleic acid C18:2	46.7	22.5
Neutral detergent fibre (%)	22.3	4.0	Linolenic acid C18:3	4.8	2.3
Acid detergent fibre (%)	17.7	2.5	Arachidic acid C20:0	1.0	0.5
Acid detergent lignin (%)	1.6	0.7	Behenic acid C22:0	1.8	0.9
Water insoluble cell walls (%)	32.9		Lignoceric acid C24:0	0.4	0.2
Starch (%)	0.0				
Total sugars (%)	5.5	1.6	Fatty acids/ether extract (%)	90	
Gross energy (MJ/kg)	18.3	0.5			

Mineral elements	mean	sd	Vitamins	mean
Calcium (g/kg)	3.2	0.7	Vitamin B1 - thiamin (mg/kg)	5
Phosphorus (g/kg)	3.7	0.6	Vitamin B2 - riboflavin (mg/kg)	3
Phytate P / total P (%)	60		Niacin (mg/kg)	32
Magnesium (g/kg)	1.8		Pantothenic acid (mg/kg)	1.4
Potassium (g/kg)	8.4		Folic acid (mg/kg)	0.36
Sodium (g/kg)	0.3		Biotin (mg/kg)	0.04
Chlorine (g/kg)	0.5		Choline (%)	2737
Sulphur (mg/kg)	2.3			
DCAD (mEq/kg)	72			
EB (mEq/kg)	214			
Manganese (mg/kg)	38			
Zinc (mg/kg)	31			
Copper (mg/kg)	5			
Iron (mg/kg)	61			
Selenium (mg/kg)	0.08			
Cobalt (mg/kg)	0.07			
Molybdenum (mg/kg)	2			
			Other	mean
			Phytase activity (UI/kg)	140

Pigs	Growing	Sow	Poultry	Cockerel	Broiler
DE (MJ/kg)	14.1	15.6	AMEn (MJ/kg)		
ME (MJ/kg)	13.1	14.1	AMEn pelleted (MJ/kg)	8.4	
NE (MJ/kg)	8.1	9.0	P availability (%)		
Ed (%)	77	85	Horses		
OMd (%)	79	87	UFC (per kg)	0.92	
Nd (%)	84	91	MADC (g/kg)	245	
NSId (%)		87	Rabbits		
EEd (%)		62	DE (MJ/kg)		
Pd (%)		50	MEn (MJ/kg)		
Ruminants			Ed (%)		
UFL (per kg)		1.13	Nd (%)		
UFV (per kg)		1.12	Fish		
PDIA (g/kg)		64	DE (MJ/kg)	11.2	
PDIN (g/kg)		199	DE extruded (MJ/kg)	14.1	
PDIE (g/kg)		124	Ed (%)	61	
ME (kcal/kg)		12.6	Ed extruded (%)	77	
Ed (%)		89	Nd (%)	86	
OMd (%)		89	Nd extruded (%)	96	
Nd (%)		80	Pd (%)		
TId (%)		89	Pd extruded (%)	62	
FAd (%)		75			
Absorbed phosphorus (g/kg)		2.7			
Ruminal degradation	Nitrogen	Starch	DM		
Effective degradability	79		76		
a (%)	36		37		
b (%)	59		60		
c (%/h)	16.0		11.0		

Amino acid content and digestibility

Amino acids	Total		Pigs				Poultry		Ruminants
	g/kg	% CP	AID	AIDC	SID	SIDC	TD	TDC	AADI
			%	g/kg	%	g/kg	%	g/kg	% PDIE
LYS	15.4	5.0	85	13.1	87	13.5			6.7
THR	11.9	3.9	79	9.5	83	9.9			5.0
MET	2.6	0.9	80	2.1	86	2.3			1.5
CYS	5.4	1.8	83	4.5	86	4.7			
MET+CYS	8.1	2.6	83	6.7	87	7.0			
TRP	2.3	0.7							
ILE	14.3	4.7	86	12.3	88	12.6			5.3
VAL	13.6	4.4	80	10.9	84	11.4			5.4
LEU	22.6	7.4	86	19.4	88	19.9			8.2
PHE	12.1	3.9	88	10.6	90	10.9			4.6
TYR	14.1	4.6	85	12.0	88	12.4			
PHE+TYR	26.2	8.5	87	22.7	89	23.4			
HIS	6.9	2.3	91	6.3	92	6.4			2.1
ARG	30.7	10.0	93	28.5	94	28.8			5.9
ALA	10.8	3.5	78	8.4	81	8.8			
ASP	32.4	10.6	87	28.2	89	28.8			
GLU	62.8	20.5	89	55.9	90	56.6			
GLY	12.5	4.1	82	10.2	85	10.6			
SER	16.5	5.4	85	14.1	87	14.4			
PRO	13.0	4.2	82	10.6	86	11.2			

Lupin, white

White lupin seed (*Lupinus albus* L.) (n = 263).

Extruded white lupin for ruminants: see page 292

All values are expressed on an as fed basis unless otherwise noted.

Main constituents	mean	sd	Fatty acids	%FA	g/kg
Dry matter (%)	88.6	3.7	Myristic acid C14:0	0.1	0.1
Crude protein (%)	34.1	3.3	Palmitic acid C16:0	8.0	6.0
Crude fibre (%)	11.4	1.5	Palmitoleic acid C16:1	0.6	0.5
Ether extract (%)	8.4	1.3	Stearic acid C18:0	1.2	0.9
Ash (%)	3.5	0.4	Oleic acid C18:1	54.7	41.4
Insoluble ash (%)	0.2		Linoleic acid C18:2	18.3	13.8
Neutral detergent fibre (%)	18.9	2.3	Linolenic acid C18:3	9.3	7.0
Acid detergent fibre (%)	13.7	1.9	Arachidic acid C20:0	1.3	1.0
Acid detergent lignin (%)	0.9	0.5	Eicosenoic acid C20:1	5.0	3.8
Water insoluble cell walls (%)	29.8	1.9	Behenic acid C22:0	3.9	2.9
Starch (%)	0.0		Erucic acid C22:1	2.1	1.6
Total sugars (%)	6.4	1.8	Lignoceric acid C24:0	1.0	0.8
Gross energy (MJ/kg)	18.8	0.8			
			Fatty acids/ether extract (%)	90	

Mineral elements	mean	sd	Vitamins	mean
Calcium (g/kg)	3.4	1.2	Vitamin E (mg/kg)	7
Phosphorus (g/kg)	3.8	0.7	Biotin (mg/kg)	0.05
Phytate P / total P (%)	60			
Magnesium (g/kg)	1.7			
Potassium (g/kg)	11.6			
Sodium (g/kg)	0.4			
Chlorine (g/kg)	0.5			
Sulphur (mg/kg)	2.5			
DCAD (mEq/kg)	144			
EB (mEq/kg)	299			
Manganese (mg/kg)	1707			
Zinc (mg/kg)	27			
Copper (mg/kg)	4			
Iron (mg/kg)	24			
Selenium (mg/kg)	0.08			
Cobalt (mg/kg)	0.18			
Molybdenum (mg/kg)	2			
			Other	mean
			Phytase activity (U/kg)	140

Pigs	Growing	Sow	Poultry	Cockerel	Broiler
DE (MJ/kg)	15.2	16.1	AMEn (MJ/kg)		
ME (MJ/kg)	14.1	14.7	AMEn pelleted (MJ/kg)	9.6	
NE (MJ/kg)	9.1	9.7	P availability (%)		24
Ed (%)	81	86	Horses		
OMd (%)	83	88	UFC (per kg)	0.93	
Nd (%)	84	88	MADC (g/kg)	273	
NSId (%)		82	Rabbits		
EEEd (%)		70	DE (MJ/kg)	12.8	
Pd (%)		50	MEEn (MJ/kg)	11.4	
Ruminants			Ed (%)	68	
UFL (per kg)		1.18	Nd (%)	80	
UFV (per kg)		1.18	Fish		
PDIA (g/kg)		47	DE (MJ/kg)		
PDIN (g/kg)		213	Ed (%)		
PDIE (g/kg)		106	Nd (%)		
ME (kcal/kg)		13.2			
Ed (%)		91			
OMd (%)		90			
Nd (%)		80			
TId (%)		89			
FAd (%)		77			
Absorbed phosphorus (g/kg)		2.8			
<i>Ruminal degradation</i>	<i>Nitrogen</i>	<i>Starch</i>	<i>DM</i>		
Effective degradability	86		76		
a (%)	66		37		
b (%)	29		60		
c (%/h)	12.5		11.0		

Amino acid content and digestibility

Amino acids	Total		Pigs				Poultry		Ruminants
	g/kg	% CP	AID	AIDC	SID	SIDC	TD	TDC	AADI % PDIE
LYS	16.6	4.9	80	13.4	82	13.6	92	15.3	6.8
THR	12.6	3.7	76	9.5	78	9.8	94	11.9	5.0
MET	2.6	0.8	73	1.9	76	2.0	91	2.4	1.6
CYS	5.6	1.6	73	4.1	76	4.2	95	5.3	
MET+CYS	8.2	2.4	73	6.0	76	6.2	94	7.7	
TRP	2.4	0.7							
ILE	15.8	4.6	85	13.5	87	13.7	96	15.2	5.4
VAL	14.7	4.3	72	10.5	74	10.8	94	13.8	5.4
LEU	24.7	7.2	84	20.8	86	21.2	96	23.7	8.2
PHE	13.3	3.9	84	11.1	86	11.4	97	12.9	4.6
TYR	15.9	4.7	88	14.0	89	14.2	96	15.3	
PHE+TYR	29.2	8.6	86	25.1	88	25.6	96	28.1	
HIS	7.4	2.2	84	6.2	86	6.3	93	6.9	2.0
ARG	37.0	10.8	92	34.0	93	34.2	98	36.2	5.9
ALA	11.5	3.4	71	8.1	73	8.4			
ASP	36.3	10.6	84	30.6	86	31.1			
GLU	70.8	20.8	89	63.0	90	63.6			
GLY	13.5	4.0	71	9.5	74	9.9			
SER	18.2	5.3	81	14.8	83	15.1	95	17.3	
PRO	14.4	4.2	80	11.5	84	12.1			

Pea

Pea seed (*Pisum sativum* L.) (n = 3932).

Extruded pea and toasted pea for ruminants: see page 292

All values are expressed on an as fed basis unless otherwise noted.

Main constituents	mean	sd	Fatty acids	%FA	g/kg
Dry matter (%)	86.4	1.1	Myristic acid C14:0	0.3	0.0
Crude protein (%)	20.7	1.2	Palmitic acid C16:0	13.2	1.1
Crude fibre (%)	5.2	0.6	Stearic acid C18:0	3.5	0.3
Ether extract (%)	1.0	0.2	Oleic acid C18:1	24.9	2.0
Ash (%)	3.0	0.4	Linoleic acid C18:2	47.4	3.9
Insoluble ash (%)	0.1	0.0	Linolenic acid C18:3	10.2	0.8
Neutral detergent fibre (%)	12.0	2.8	Arachidic acid C20:0	3.3	0.3
Acid detergent fibre (%)	6.0	0.7			
Acid detergent lignin (%)	0.3	0.3	Fatty acids/ether extract (%)	80	
Water insoluble cell walls (%)	12.8	1.1			
Starch (%)	44.6	2.0			
Total sugars (%)	3.9	0.4			
Gross energy (MJ/kg)	15.8	0.3			

Mineral elements	mean	sd	Vitamins	mean
Calcium (g/kg)	1.1	0.5	Vitamin A (1000 UI/kg)	0.43
Phosphorus (g/kg)	4.0	0.5	Vitamin E (mg/kg)	4
Phytate P / total P (%)	45		Vitamin K (mg/kg)	0.79
Magnesium (g/kg)	1.4	0.6	Vitamin B1 - thiamin (mg/kg)	5
Potassium (g/kg)	9.8	0.6	Vitamin B2 - riboflavin (mg/kg)	2
Sodium (g/kg)	0.1	0.1	Vitamin B6 - pyridoxine (mg/kg)	4
Chlorine (g/kg)	0.8	0.2	Vitamin B12 (µg/kg)	0
Sulphur (mg/kg)	2.0	0.1	Niacin (mg/kg)	25
DCAD (mEq/kg)	103		Pantothenic acid (mg/kg)	14
EB (mEq/kg)	229		Folic acid (mg/kg)	0.83
Manganese (mg/kg)	9	3	Biotin (mg/kg)	0.18
Zinc (mg/kg)	32	7	Vitamin C (mg/kg)	16
Copper (mg/kg)	7	1	Choline (%)	592
Iron (mg/kg)	92	29		
Selenium (mg/kg)	0.15			
Cobalt (mg/kg)	0.09			
Molybdenum (mg/kg)	2			
Iodine (mg/kg)	0.26			
			Other	mean
			Phytase activity (UI/kg)	130

Pigs	Growing	Sow	Poultry	Cockerel	Broiler
DE (MJ/kg)	13.9	14.4	AMEn ground (MJ/kg)	10.4	10.2
ME (MJ/kg)	13.2	13.6	AMEn pelleted (MJ/kg)	11.5	11.3
NE (MJ/kg)	9.7	10.0	P availability (%)		26
Ed (%)	88	91	Horses		
OMd (%)	90	93	UFC (per kg)	0.96	
Nd (%)	84	87	MADC (g/kg)	171	
NSId (%)		80	Rabbits		
EEd (%)		0	DE (MJ/kg)	12.9	
Pd (%)		47	MEEn (MJ/kg)	12.1	
Ruminants			Ed (%)	82	
UFL (per kg)		1.04	Nd (%)	83	
UFV (per kg)		1.05	Fish		
PDIA (g/kg)		29	DE (MJ/kg)	9.3	
PDIN (g/kg)		130	DE extruded (MJ/kg)	10.9	
PDIE (g/kg)		83	Ed (%)	59	
ME (kcal/kg)		11.6	Ed extruded (%)	69	
Ed (%)		90	Nd (%)	80	
OMd (%)		92	Nd extruded (%)	88	
Nd (%)		78	Pd (%)		
TId (%)		91	Pd extruded (%)	43	
FAd (%)		57			
Absorbed phosphorus (g/kg)		2.9			
<i>Ruminal degradation</i>	<i>Nitrogen</i>	<i>Starch</i>	<i>DM</i>		
Effective degradability	86	79	80		
a (%)	67	46	56		
b (%)	29	54	42		
c (%/h)	11.5	9.5	8.0		

Amino acid content and digestibility

Amino acids	Total		Pigs				Poultry		Ruminants
	g/kg	% CP	AID	AIDC	SID	SIDC	TD	TDC	AADI
			%	g/kg	%	g/kg	%	g/kg	% PDIE
LYS	15.0	7.3	81	12.2	83	12.4	79	11.9	7.7
THR	7.8	3.8	73	5.7	76	6.0	81	6.4	5.1
MET	2.0	1.0	77	1.5	80	1.6			1.7
CYS	2.8	1.3	68	1.9	72	2.0			
MET+CYS	4.8	2.3	71	3.4	75	3.6			
TRP	1.8	0.9	69	1.3	73	1.3			
ILE	8.6	4.2	77	6.6	79	6.8	84	7.3	5.3
VAL	9.7	4.7	74	7.2	77	7.5	82	8.0	5.7
LEU	14.7	7.1	77	11.4	80	11.7	87	12.8	8.2
PHE	9.7	4.7	78	7.6	80	7.8	82	8.0	5.1
TYR	6.4	3.1	78	5.0	81	5.2			
PHE+TYR	16.1	7.8	78	12.6	80	13.0			
HIS	5.2	2.5	82	4.3	84	4.4	87	4.5	2.1
ARG	17.8	8.6	88	15.7	89	15.8			5.3
ALA	9.0	4.4	72	6.5	75	6.7	87	7.9	
ASP	24.1	11.7	80	19.3	82	19.7			
GLU	33.8	16.4	82	27.7	84	28.2			
GLY	9.1	4.4	73	6.7	78	7.1			
SER	9.6	4.7	76	7.3	79	7.6			
PRO	8.6	4.2	72	6.2	78	6.7			

Rapeseed, full fat

Rape seed (*Brassica napus* L.) of low-erucic, low-glucosinolates ('00') varieties (n = 959).

Extruded rapeseed and formaldehyde-treated rapeseed for ruminants: see page 292

All values are expressed on an as fed basis unless otherwise noted.

Main constituents	mean	sd	Fatty acids	%FA	g/kg
Dry matter (%)	92.2	1.2	Myristic acid C14:0	0.1	0.4
Crude protein (%)	19.1	1.3	Palmitic acid C16:0	4.2	16.8
Crude fibre (%)	8.2	2.0	Palmitoleic acid C16:1	0.4	1.6
Ether extract (%)	42.0	2.2	Stearic acid C18:0	1.8	7.2
Ash (%)	4.0	0.2	Oleic acid C18:1	58.0	231.3
Insoluble ash (%)	0.3	0.9	Linoleic acid C18:2	20.5	81.8
Neutral detergent fibre (%)	17.6	4.4	Linolenic acid C18:3	9.8	39.1
Acid detergent fibre (%)	12.4	3.4	Fatty acids/ether extract (%)	95	
Acid detergent lignin (%)	5.5	1.7			
Water insoluble cell walls (%)	20.5				
Starch (%)	0.0				
Total sugars (%)	5.1	0.7			
Gross energy (MJ/kg)	26.4	0.5			

Mineral elements	mean	sd	Vitamins	mean
Calcium (g/kg)	4.7	1.2	Vitamin E (mg/kg)	117
Phosphorus (g/kg)	6.6	0.9		
Phytate P / total P (%)	70			
Magnesium (g/kg)	2.4	0.3		
Potassium (g/kg)	7.8	0.7		
Sodium (g/kg)	0.2	0.2		
Chlorine (g/kg)	0.9	0.4		
Sulphur (mg/kg)	3.3			
DCAD (mEq/kg)	-21			
EB (mEq/kg)	184			
Manganese (mg/kg)	34			
Zinc (mg/kg)	40			
Copper (mg/kg)	3			
Iron (mg/kg)	216			
Selenium (mg/kg)	0.77			

Pigs	Growing	Sow	Poultry	Cockerel	Broiler
DE (MJ/kg)	21.9	22.4	AMEn ground (MJ/kg)	14.2	13.2
ME (MJ/kg)	21.3	21.6	AMEn pelleted (MJ/kg)	18.5	17.5
NE (MJ/kg)	16.7	17.0	P availability (%)		
Ed (%)	83	85	Horses		
OMd (%)	81	84	UFC (per kg)	1.32	
Nd (%)	80	84	MADC (g/kg)	151	
NSId (%)		72	Rabbits		
EEEd (%)		85	DE (MJ/kg)	21.5	
Pd (%)		30	MEn (MJ/kg)	20.6	
Ruminants			Ed (%)	81	
UFL (per kg)		1.68	Nd (%)	80	
UFV (per kg)		1.68	Fish		
PDIA (g/kg)		36	DE (MJ/kg)		
PDIN (g/kg)		120	DE extruded (MJ/kg)	20.4	
PDIE (g/kg)		61	Ed (%)		
ME (kcal/kg)		18.7	Ed extruded (%)	77	
Ed (%)		87	Nd (%)		
OMd (%)		83	Nd extruded (%)	81	
Nd (%)		75	Pd extruded (%)		
TId (%)		80			
FAd (%)		79			
Absorbed phosphorus (g/kg)		4.8			
Ruminal degradation	Nitrogen	Starch	DM		
Effective degradability	79		65		
a (%)	40				
b (%)	55				
c (%/h)	14.5				

Amino acid content and digestibility

Amino acids	Total		Pigs				Poultry		Ruminants
	g/kg	% CP	AID	AIDC	SID	SIDC	TD	TDC	AADI % PDIE
LYS	11.9	6.2	75	9.0	78	9.3	87	10.4	7.4
THR	9.1	4.8	67	6.1	71	6.4	80	7.3	5.3
MET	4.2	2.2	79	3.3	81	3.4	86	3.6	2.1
CYS	4.7	2.5	77	3.6	80	3.8	75	3.5	
MET+CYS	8.9	4.7	78	6.9	80	7.1	80	7.1	
TRP	2.5	1.3	69	1.7	73	1.8			
ILE	7.7	4.0	66	5.0	68	5.3	85	6.5	5.2
VAL	10.0	5.2	67	6.6	70	6.9	85	8.5	5.8
LEU	12.2	6.4	68	8.3	71	8.7	89	10.9	8.0
PHE	7.2	3.8	70	5.0	73	5.3	90	6.5	4.6
TYR	5.5	2.9	71	3.9	74	4.1	84	4.6	
PHE+TYR	12.8	6.7	70	8.9	73	9.3	87	11.1	
HIS	5.1	2.7	72	3.6	73	3.7	84	4.3	2.3
ARG	11.4	6.0	79	9.0	81	9.2	92	10.5	5.1
ALA	8.6	4.5	68	5.9	72	6.2			
ASP	13.5	7.1	69	9.3	72	9.8			
GLU	28.6	14.9	80	22.8	82	23.4			
GLY	8.9	4.6	68	6.0	72	6.4			
SER	8.5	4.5	67	5.7	71	6.0	83	7.1	
PRO	12.4	6.5	78	9.6	82	10.1			

Soybean, full fat, extruded

Extruded soybean seed (*Glycine max* (L.) Merr.) (n = 1162).

Flaked soybean and formaldehyde-treated soybean for ruminants: see page 292

All values are expressed on an as fed basis unless otherwise noted.

Main constituents	mean	sd	Fatty acids	%FA	g/kg
Dry matter (%)	88.1	1.6	Myristic acid C14:0	0.1	0.2
Crude protein (%)	34.8	1.4	Palmitic acid C16:0	10.5	17.8
Crude fibre (%)	5.2	1.2	Palmitoleic acid C16:1	0.2	0.3
Ether extract (%)	17.9	1.4	Stearic acid C18:0	3.8	6.5
Ash (%)	5.2	0.5	Oleic acid C18:1	21.7	36.9
Insoluble ash (%)	1.1		Linoleic acid C18:2	53.1	90.2
Neutral detergent fibre (%)	11.0	2.3	Linolenic acid C18:3	7.4	12.6
Acid detergent fibre (%)	6.4	2.0			
Acid detergent lignin (%)	1.0	0.7	Fatty acids/ether extract (%)	95	
Water insoluble cell walls (%)	20.0				
Starch (%)	0.0				
Total sugars (%)	7.7	0.8			
Gross energy (MJ/kg)	20.4	0.6			

Mineral elements	mean	sd	Vitamins	mean
Calcium (g/kg)	3.1	0.7	Vitamin E (mg/kg)	36
Phosphorus (g/kg)	5.5	0.5	Vitamin B1 - thiamin (mg/kg)	10
Phytate P / total P (%)	60		Vitamin B2 - riboflavin (mg/kg)	3
Magnesium (g/kg)	2.3		Vitamin B6 - pyridoxine (mg/kg)	10
Potassium (g/kg)	18.5		Vitamin B12 (µg/kg)	0
Sodium (g/kg)	0.8		Niacin (mg/kg)	22
Chlorine (g/kg)	0.4	0.3	Pantothenic acid (mg/kg)	15
Sulphur (mg/kg)	2.8		Folic acid (mg/kg)	4
DCAD (mEq/kg)	327		Biotin (mg/kg)	0.27
EB (mEq/kg)	500		Choline (%)	2119
Manganese (mg/kg)	23			
Zinc (mg/kg)	40			
Copper (mg/kg)	34			
Iron (mg/kg)	146			
Selenium (mg/kg)	0.28			
Molybdenum (mg/kg)	4			
Iodine (mg/kg)	0.09			

Pigs	Growing	Sow	Poultry	Cockerel	Broiler
DE (MJ/kg)	15.9	17.3	AMEn (MJ/kg)		
ME (MJ/kg)	14.9	16.1	AMEn pelleted (MJ/kg)	14.4	14.0
NE (MJ/kg)	10.7	11.5	P availability (%)		
Ed (%)	78	85	Horses		
OMd (%)	79	87	UFC (per kg)	0.98	
Nd (%)	85	91	MADC (g/kg)	296	
NSId (%)		83	Rabbits		
EEEd (%)		80	DE (MJ/kg)	17.0	
Pd (%)		32	MEEn (MJ/kg)	15.5	
Ruminants			Ed (%)	83	
UFL (per kg)		1.27	Nd (%)	83	
UFV (per kg)		1.27	Fish		
PDIA (g/kg)		180	DE (MJ/kg)		
PDIN (g/kg)		262	DE extruded (MJ/kg)	17.5	
PDIE (g/kg)		214	Ed (%)		
ME (kcal/kg)		14.2	Ed extruded (%)	86	
Ed (%)		90	Nd (%)		
OMd (%)		88	Nd extruded (%)	97	
Nd (%)		79	Pd extruded (%)		
TId (%)		88			
FAd (%)		78			
Absorbed phosphorus (g/kg)		4.0			
Ruminal degradation	Nitrogen	Starch	DM		
Effective degradability	47	58			
a (%)	16	29			
b (%)	80	64			
c (%/h)	4.0	5.0			

Amino acid content and digestibility

Amino acids	Total		Pigs				Poultry		Ruminants
	g/kg	% CP	AID	AIDC	SID	SIDC	TD	TDC	AADI % PDIE
LYS	21.6	6.2	86	18.5	87	18.8	88	19.0	6.8
THR	14.0	4.0	81	11.4	84	11.7	85	11.9	4.7
MET	5.3	1.5	83	4.4	85	4.5	86	4.5	1.5
CYS	5.6	1.6	77	4.3	80	4.5	77	4.3	
MET+CYS	10.9	3.1	80	8.7	83	9.0	81	8.9	
TRP	4.4	1.3	74	3.3	77	3.4			
ILE	16.1	4.6	83	13.4	85	13.6	87	14.0	5.1
VAL	16.6	4.8	82	13.7	84	14.0	86	14.3	5.3
LEU	25.9	7.5	83	21.6	85	22.0	87	22.6	8.3
PHE	17.4	5.0	85	14.8	86	15.0	88	15.4	5.1
TYR	12.3	3.5	86	10.5	88	10.8	88	10.8	
PHE+TYR	29.7	8.5	85	25.3	87	25.8	88	26.1	
HIS	9.3	2.7	87	8.1	88	8.2	87	8.1	2.4
ARG	25.7	7.4	90	23.0	91	23.3	91	23.4	5.7
ALA	14.1	4.1	81	11.4	83	11.7			
ASP	38.8	11.2	86	33.3	87	33.9			
GLU	61.7	17.7	87	53.6	88	54.3			
GLY	14.8	4.2	80	11.8	82	12.2	83	12.3	
SER	17.8	5.1	84	14.9	85	15.2	87	15.4	
PRO	18.3	5.3	85	15.6	88	16.1			

Soybean, full fat, toasted

Toasted soybean seed (*Glycine max* (L.) Merr.) (n = 1068).

Flaked soybean and formaldehyde-treated soybean for ruminants: see page 292

All values are expressed on an as fed basis unless otherwise noted.

Main constituents	mean	sd	Fatty acids	%FA	g/kg
Dry matter (%)	88.6	1.5	Myristic acid C14:0	0.1	0.2
Crude protein (%)	35.2	1.5	Palmitic acid C16:0	10.5	19.2
Crude fibre (%)	5.6	1.3	Palmitoleic acid C16:1	0.2	0.4
Ether extract (%)	19.2	1.4	Stearic acid C18:0	3.8	6.9
Ash (%)	5.2	0.5	Oleic acid C18:1	21.7	39.6
Neutral detergent fibre (%)	11.7	1.6	Linoleic acid C18:2	53.1	97.0
Acid detergent fibre (%)	6.9	1.2	Linolenic acid C18:3	7.4	13.5
Acid detergent lignin (%)	1.2	0.6			
Water insoluble cell walls (%)	20.3	2.4	Fatty acids/ether extract (%)	95	
Starch (%)	0.0				
Total sugars (%)	8.8				
Gross energy (MJ/kg)	20.8	0.7			

Mineral elements	mean	sd	Vitamins	mean
Calcium (g/kg)	3.2	0.7	Vitamin E (mg/kg)	36
Phosphorus (g/kg)	5.3	0.5	Vitamin B1 - thiamin (mg/kg)	10
Phytate P / total P (%)	60		Vitamin B2 - riboflavin (mg/kg)	3
Magnesium (g/kg)	2.3	0.2	Vitamin B6 - pyridoxine (mg/kg)	10
Potassium (g/kg)	18.4	1.1	Vitamin B12 (µg/kg)	0
Sodium (g/kg)	0.8		Niacin (mg/kg)	22
Chlorine (g/kg)	0.5	0.2	Pantothenic acid (mg/kg)	15
Sulphur (mg/kg)	2.8		Folic acid (mg/kg)	4
DCAD (mEq/kg)	321		Biotin (mg/kg)	0.27
EB (mEq/kg)	496		Choline (%)	2131
Manganese (mg/kg)	28			
Zinc (mg/kg)	40			
Copper (mg/kg)	34			
Iron (mg/kg)	143			
Selenium (mg/kg)	0.28			
Molybdenum (mg/kg)	4			

Pigs	Growing	Sow	Poultry	Cockerel	Broiler
DE (MJ/kg)	16.2	17.6	AMEn (MJ/kg)		
ME (MJ/kg)	15.2	16.4	AMEn pelleted (MJ/kg)	14.1	13.7
NE (MJ/kg)	11.0	11.8	P availability (%)		
Ed (%)	78	85	Horses		
OMd (%)	79	87	UFC (per kg)		
Nd (%)	85	91	MADC (g/kg)		
NSId (%)		74	Rabbits		
EEd (%)		80	DE (MJ/kg)	17.1	
Pd (%)		32	MEEn (MJ/kg)	15.6	
Ruminants			Ed (%)	82	
UFL (per kg)		1.30	Nd (%)	83	
UFV (per kg)		1.30	Fish		
PDIA (g/kg)		118	DE (MJ/kg)	17.2	
PDIN (g/kg)		238	Ed (%)	83	
PDIE (g/kg)		157	Nd (%)	91	
ME (kcal/kg)		14.6	Pd (%)		
Ed (%)		90			
OMd (%)		88			
Nd (%)		79			
TId (%)		82			
FAd (%)		78			
Absorbed phosphorus (g/kg)		3.8			
Ruminal degradation	Nitrogen	Starch	DM		
Effective degradability	63		65		
a (%)	18				
b (%)	76				
c (%/h)	8.5				

Amino acid content and digestibility

Amino acids	Total		Pigs				Poultry		Ruminants
	g/kg	% CP	AID	AIDC	SID	SIDC	TD	TDC	AADI % PDIE
LYS	21.8	6.2	77	16.9	79	17.2	81	17.7	6.9
THR	14.2	4.0	73	10.4	75	10.7	79	11.2	4.8
MET	5.3	1.5	76	4.0	78	4.1	82	4.4	1.6
CYS	5.7	1.6	73	4.1	75	4.3	76	4.3	
MET+CYS	11.0	3.1	74	8.2	76	8.4	79	8.7	
TRP	4.5	1.3	81	3.6	83	3.7			
ILE	16.2	4.6	73	11.8	74	12.0	79	12.8	5.1
VAL	16.8	4.8	72	12.1	74	12.4	77	12.9	5.3
LEU	26.2	7.5	74	19.5	76	19.8	80	21.0	8.2
PHE	17.6	5.0	76	13.3	77	13.6	80	14.1	5.1
TYR	12.4	3.5	77	9.5	78	9.7	81	10.0	
PHE+TYR	30.0	8.5	76	22.9	78	23.3	80	24.1	
HIS	9.4	2.7	80	7.5	81	7.6	86	8.1	2.4
ARG	26.0	7.4	82	21.2	83	21.5	85	22.1	5.5
ALA	14.3	4.1	71	10.2	74	10.5			
ASP	39.3	11.2	77	30.1	78	30.6			
GLU	62.4	17.7	77	48.2	78	48.8			
GLY	14.9	4.2	71	10.6	74	11.0	75	11.2	
SER	17.9	5.1	76	13.7	78	13.9	80	14.4	
PRO	18.5	5.3	70	13.0	73	13.4			

Sunflower seed, full fat

Whole sunflower seed (*Helianthus annuus* L.) (n = 182).

All values are expressed on an as fed basis unless otherwise noted.

Main constituents	mean	sd	Fatty acids	%FA	g/kg
Dry matter (%)	93.0	2.2	Myristic acid C14:0	0.2	0.8
Crude protein (%)	16.0	1.5	Palmitic acid C16:0	6.3	26.7
Crude fibre (%)	15.5	2.0	Palmitoleic acid C16:1	0.4	1.7
Ether extract (%)	44.6	2.9	Stearic acid C18:0	4.3	18.2
Ash (%)	3.4	0.3	Oleic acid C18:1	20.3	86.0
Insoluble ash (%)	0.0	0.0	Linoleic acid C18:2	64.9	274.9
Neutral detergent fibre (%)	28.8	4.0	Linolenic acid C18:3	0.3	1.3
Acid detergent fibre (%)	18.7	2.2	Fatty acids/ether extract (%)	95	
Acid detergent lignin (%)	5.7	1.0			
Water insoluble cell walls (%)	30.0				
Starch (%)	0.0				
Total sugars (%)	2.4	0.1			
Gross energy (MJ/kg)	26.7				

Mineral elements	mean	sd	Vitamins	mean
Calcium (g/kg)	2.8	1.2	Vitamin B1 - thiamin (mg/kg)	19
Phosphorus (g/kg)	5.4	0.9	Vitamin B2 - riboflavin (mg/kg)	1.4
Phytate P / total P (%)	85		Vitamin B6 - pyridoxine (mg/kg)	6
Magnesium (g/kg)	2.8	0.3	Niacin (mg/kg)	41
Potassium (g/kg)	9.1	0.9		
Sodium (g/kg)	0.1	0.1		
Chlorine (g/kg)	0.9	0.2		
Sulphur (mg/kg)	2.0			
DCAD (mEq/kg)	88			
EB (mEq/kg)	211			
Manganese (mg/kg)	33			
Zinc (mg/kg)	51			
Copper (mg/kg)	21			
Iron (mg/kg)	134			
Selenium (mg/kg)	0.58			
Molybdenum (mg/kg)	1.7			

Pigs	Growing	Sow	Poultry	Cockerel	Broiler
DE (MJ/kg)	18.9	19.8	AMEn ground (MJ/kg)	18.3	17.2
ME (MJ/kg)	18.4	19.0	AMEn pelleted (MJ/kg)	19.0	18.0
NE (MJ/kg)	15.4	15.7	P availability (%)		
Ed (%)	71	74	Horses		
OMd (%)	69	74	UFC (per kg)	1.21	
Nd (%)	80	87	MADC (g/kg)	126	
EEd (%)		85	Rabbits		
Ruminants			DE (MJ/kg)		
UFL (per kg)		1.44	MEn (MJ/kg)		
UFV (per kg)		1.39	Ed (%)		
PDIA (g/kg)		16	Nd (%)		
PDIN (g/kg)		97	Fish		
PDIE (g/kg)		33	DE (MJ/kg)		
ME (kcal/kg)		16.6	Ed (%)		
Ed (%)		77	Nd (%)		
OMd (%)		72			
Nd (%)		69			
TId (%)		80			
FAd (%)		79			
Absorbed phosphorus (g/kg)		4.0			
<i>Ruminal degradation</i>	<i>Nitrogen</i>	<i>Starch</i>	<i>DM</i>		
Effective degradability	89	70			
a (%)	77	60			
b (%)	13	18			
c (%/h)	60.5	7.5			

Amino acid content and digestibility

Amino acids	Total		Pigs				Poultry		Ruminants
	g/kg	% CP	AID %	AIDC g/kg	SID %	SIDC g/kg	TD %	TDC g/kg	AADI % PDIE
LYS	6.3	3.9							6.5
THR	6.0	3.7							5.0
MET	3.8	2.3							2.2
CYS	2.9	1.8							
MET+CYS	6.6	4.1							
TRP	2.0	1.2							
ILE	6.5	4.1							5.3
VAL	7.4	4.6							5.7
LEU	9.5	5.9							7.9
PHE	6.8	4.3							5.0
TYR	4.5	2.8							
PHE+TYR	11.3	7.1							
HIS	4.0	2.5							2.2
ARG	12.7	7.9							5.5
ALA	7.6	4.7							
ASP	13.1	8.2							
GLU	25.5	15.9							
GLY	9.4	5.9							
SER	7.2	4.5							
PRO	6.9	4.3							

Cocoa meal, extracted

By-product from the manufacture of cocoa butter (*Theobroma cacao* L.), obtained by complete extraction of cocoa beans (n = 33).

All values are expressed on an as fed basis unless otherwise noted.

Main constituents	mean	sd	Fatty acids	%FA	g/kg
Dry matter (%)	88.2	1.6	Myristic acid C14:0	0.1	0.0
Crude protein (%)	25.2	0.8	Palmitic acid C16:0	25.5	1.0
Crude fibre (%)	14.6	1.9	Palmitoleic acid C16:1	0.2	0.0
Ether extract (%)	0.5	0.7	Stearic acid C18:0	33.8	1.3
Ash (%)	8.9	1.5	Oleic acid C18:1	33.3	1.3
Insoluble ash (%)	1.3		Linoleic acid C18:2	2.3	0.1
Neutral detergent fibre (%)	37.6	8.8	Linolenic acid C18:3	0.5	0.0
Acid detergent fibre (%)	28.0	6.3	Arachidic acid C20:0	1.0	0.0
Acid detergent lignin (%)	14.5	3.5			
Starch (%)	9.1	1.3	Fatty acids/ether extract (%)	75	
Total sugars (%)	0.8				
Gross energy (MJ/kg)	15.9				

Mineral elements	mean	sd
Calcium (g/kg)	2.2	0.1
Phosphorus (g/kg)	6.5	
Sodium (g/kg)	0.1	
Chlorine (g/kg)	0.3	

Pigs	Growing	Sow	Poultry	Cockerel	Broiler
DE (MJ/kg)	9.7	10.5	AMEn (MJ/kg)		
ME (MJ/kg)	9.0	9.6	P availability (%)		
NE (MJ/kg)	5.5	5.9			
Ed (%)	61	67	Horses		
OMd (%)	65	70	UFC (per kg)		
Nd (%)	66	71	MADC (g/kg)		
EEd (%)		0			
Ruminants			Rabbits		
UFL (per kg)		0.43	DE (MJ/kg)		
UFV (per kg)		0.33	MEEn (MJ/kg)		
PDIA (g/kg)		36	Ed (%)		
PDIN (g/kg)		149	Nd (%)		
PDIE (g/kg)		66	Fish		
ME (kcal/kg)		5.5	DE (MJ/kg)		
Ed (%)		45	Ed (%)		
OMd (%)		47	Nd (%)		
Nd (%)		69			
TId (%)		65			
FAd (%)		31			
Absorbed phosphorus (g/kg)		4.4			
Ruminal degradation	Nitrogen	Starch	DM		
Effective degradability	80		45		
a (%)					
b (%)					
c (%/h)					

Amino acid content and digestibility

Amino acids	Total		Pigs				Poultry		Ruminants
	g/kg	% CP	AID %	AIDC g/kg	SID %	SIDC g/kg	TD %	TDC g/kg	AADI % PDIE
LYS	10.8	4.3							6.9
THR	8.8	3.5							5.1
MET	2.3	0.9							1.6
CYS	2.8	1.1							
MET+CYS	5.0	2.0							
TRP	2.8	1.1							
ILE	8.8	3.5							5.2
VAL	9.6	3.8							5.5
LEU	15.6	6.2							8.4
PHE	10.6	4.2							5.3
TYR	6.8	2.7							
PHE+TYR	17.4	6.9							
HIS	4.0	1.6							2.0
ARG	12.6	5.0							5.1
ALA	10.1	4.0							
ASP	21.7	8.6							
GLU	37.8	15.0							
GLY	8.1	3.2							
SER	10.1	4.0							
PRO	8.1	3.2							

Copra meal, expeller

By-product from the manufacture of coconut oil (*Cocos nucifera* L.), obtained by mechanical extraction of dried coconut kernels (copra) (n = 124).

All values are expressed on an as fed basis unless otherwise noted.

Main constituents	mean	sd	Fatty acids	%FA	g/kg
Dry matter (%)	91.2	1.8	Sum C6 + C8 + C10	13.1	9.6
Crude protein (%)	20.5	1.3	Lauric acid C12:0	46.4	34.0
Crude fibre (%)	12.8	2.5	Myristic acid C14:0	17.7	13.0
Ether extract (%)	8.2	1.6	Palmitic acid C16:0	8.9	6.5
Ash (%)	6.2	0.8	Palmitoleic acid C16:1	0.4	0.3
Insoluble ash (%)	0.1		Stearic acid C18:0	3.0	2.2
Neutral detergent fibre (%)	49.7	5.8	Oleic acid C18:1	6.5	4.8
Acid detergent fibre (%)	26.1	3.6	Linoleic acid C18:2	1.8	1.3
Acid detergent lignin (%)	6.1	1.9	Linolenic acid C18:3	0.1	0.1
Water insoluble cell walls (%)	41.0		Arachidic acid C20:0	0.5	0.4
Starch (%)	0.0				
Total sugars (%)	10.3		Fatty acids/ether extract (%)	90	
Gross energy (MJ/kg)	18.2	1.3			

Mineral elements	mean	sd	Vitamins	mean
Calcium (g/kg)	1.2	0.5	Vitamin E (mg/kg)	8
Phosphorus (g/kg)	5.4	0.6	Vitamin B1 - thiamin (mg/kg)	0.69
Phytate P / total P (%)	50		Vitamin B2 - riboflavin (mg/kg)	3
Magnesium (g/kg)	2.9	0.4	Vitamin B6 - pyridoxine (mg/kg)	4
Potassium (g/kg)	16.8	5.6	Niacin (mg/kg)	28
Sodium (g/kg)	0.7		Pantothenic acid (mg/kg)	6
Chlorine (g/kg)	6.2		Folic acid (mg/kg)	0.30
Sulphur (mg/kg)	2.7		Biotin (mg/kg)	0.25
DCAD (mEq/kg)	117		Choline (%)	1079
EB (mEq/kg)	286			
Manganese (mg/kg)	94			
Zinc (mg/kg)	49			
Copper (mg/kg)	32			
Iron (mg/kg)	696			
Cobalt (mg/kg)	0.20			
Molybdenum (mg/kg)	0.61			
Iodine (mg/kg)	1.3			

Pigs	Growing	Sow	Poultry	Cockerel	Broiler
DE (MJ/kg)	9.9	10.9	AMEn (MJ/kg)		
ME (MJ/kg)	9.2	10.0	P availability (%)		
NE (MJ/kg)	6.2	6.8			
Ed (%)	54	60	Horses		
OMd (%)	58	64	UFC (per kg)	0.69	
Nd (%)	71	79	MADC (g/kg)	146	
EEd (%)		62			
Pd (%)		31	Rabbits		
			DE (MJ/kg)	12.3	
Ruminants			MEEn (MJ/kg)	11.6	
UFL (per kg)	0.95		Ed (%)	68	
UFV (per kg)	0.91		Nd (%)	65	
PDIA (g/kg)	101				
PDIN (g/kg)	154		Fish		
PDIE (g/kg)	145		DE (MJ/kg)		
ME (kcal/kg)	11.0		Ed (%)		
Ed (%)	76		Nd (%)		
OMd (%)	76				
Nd (%)	75				
TId (%)	89				
FAd (%)	77				
Absorbed phosphorus (g/kg)	3.7				
<i>Ruminal degradation</i>	<i>Nitrogen</i>	<i>Starch</i>	<i>DM</i>		
Effective degradability	50		72		
a (%)	19		46		
b (%)	69		37		
c (%/h)	5.0		15.0		

Amino acid content and digestibility

Amino acids	Total		Pigs				Poultry		Ruminants
	g/kg	% CP	AID %	AIDC g/kg	SID %	SIDC g/kg	TD %	TDC g/kg	AADI % PDIE
LYS	5.4	2.6							5.4
THR	6.1	3.0							4.7
MET	2.8	1.4							1.7
CYS	2.6	1.3							
MET+CYS	5.4	2.7							
TRP	2.8	1.3							
ILE	6.2	3.0							4.8
VAL	9.6	4.7							5.8
LEU	11.9	5.8							8.0
PHE	8.3	4.1							5.1
TYR	4.2	2.0							
PHE+TYR	12.5	6.1							
HIS	3.9	1.9							2.2
ARG	21.7	10.6							7.2
ALA	8.1	3.9							
ASP	15.5	7.5							
GLU	34.9	17.0							
GLY	8.4	4.1							
SER	8.9	4.3							
PRO	7.0	3.4							

Cottonseed meal, crude fibre 7-14%

By-product from the manufacture of cottonseed oil, obtained by solvent extraction of dehulled cottonseeds. This product contains 7% to 14% crude fibre (as fed) (n = 117).

Toasted cottonseed meal for ruminants: see page 293

All values are expressed on an as fed basis unless otherwise noted.

Main constituents	mean	sd	Fatty acids	%FA	g/kg
Dry matter (%)	91.3	1.8	Lauric acid C12:0	0.5	0.1
Crude protein (%)	42.6	3.2	Myristic acid C14:0	0.9	0.2
Crude fibre (%)	11.9	1.9	Palmitic acid C16:0	23.0	4.9
Ether extract (%)	2.9	1.5	Palmitoleic acid C16:1	0.9	0.2
Ash (%)	6.7	0.6	Stearic acid C18:0	2.4	0.5
Insoluble ash (%)	1.0	2.1	Oleic acid C18:1	17.2	3.7
Neutral detergent fibre (%)	24.8	4.9	Linoleic acid C18:2	52.3	11.2
Acid detergent fibre (%)	16.5	2.9	Linolenic acid C18:3	0.2	0.0
Acid detergent lignin (%)	5.5	1.2			
Water insoluble cell walls (%)	28.1	5.2	Fatty acids/ether extract (%)	75	
Starch (%)	0.0				
Total sugars (%)	6.3				
Gross energy (MJ/kg)	18.7	0.9			

Mineral elements	mean	sd	Vitamins	mean
Calcium (g/kg)	2.5	1.0	Vitamin E (mg/kg)	21
Phosphorus (g/kg)	11.7	1.6	Vitamin B1 - thiamin (mg/kg)	7
Phytate P / total P (%)	70		Vitamin B2 - riboflavin (mg/kg)	4
Magnesium (g/kg)	6.0	0.6	Vitamin B6 - pyridoxine (mg/kg)	6
Potassium (g/kg)	15.6	0.9	Vitamin B12 (µg/kg)	0
Sodium (g/kg)	2.5		Niacin (mg/kg)	40
Chlorine (g/kg)	0.3		Pantothenic acid (mg/kg)	12
Sulphur (mg/kg)	3.3		Folic acid (mg/kg)	1.5
DCAD (mEq/kg)	295		Biotin (mg/kg)	0.63
EB (mEq/kg)	500		Choline (%)	2767
Manganese (mg/kg)	25			
Zinc (mg/kg)	72			
Copper (mg/kg)	19			
Iron (mg/kg)	159			
Selenium (mg/kg)	0.38			
Cobalt (mg/kg)	0.57			
Molybdenum (mg/kg)	0.80			
Iodine (mg/kg)	0.10			

Pigs	Growing	Sow	Poultry	Cockerel	Broiler
DE (MJ/kg)	13.6	14.3	AMEn (MJ/kg)	8.6	
ME (MJ/kg)	12.3	12.8	P availability (%)		
NE (MJ/kg)	7.4	7.8	Horses		
Ed (%)	73	76	UFC (per kg)		
OMd (%)	74	78	MADC (g/kg)		
Nd (%)	93	96	Rabbits		
NSId (%)		77	DE (MJ/kg)		
EEEd (%)		42	MEEn (MJ/kg)		
Pd (%)		26	Ed (%)		
			Nd (%)		
Ruminants			Fish		
UFL (per kg)		0.94	DE (MJ/kg)		
UFV (per kg)		0.89	Ed (%)		
PDIA (g/kg)		166	Nd (%)		
PDIN (g/kg)		305			
PDIE (g/kg)		209			
ME (kcal/kg)		11.0			
Ed (%)		78			
OMd (%)		78			
Nd (%)		78			
TId (%)		90			
FAd (%)		70			
Absorbed phosphorus (g/kg)		7.5			
Ruminal degradation	Nitrogen	Starch	DM		
Effective degradability	61		59		
a (%)	29		27		
b (%)	60		64		
c (%/h)	6.5		6.0		

Amino acid content and digestibility

Amino acids	Total		Pigs				Poultry		Ruminants
	g/kg	% CP	AID	AIDC	SID	SIDC	TD	TDC	AADI
			%	g/kg	%	g/kg	%	g/kg	% PDIE
LYS	16.8	3.9	61	10.3	63	10.6	63	10.6	5.8
THR	13.3	3.1	68	9.0	71	9.4	69	9.2	4.5
MET	6.0	1.4	71	4.3	73	4.4	75	4.5	1.6
CYS	7.3	1.7	73	5.3	76	5.5	67	4.9	
MET+CYS	13.3	3.1	73	9.7	75	10.0	71	9.4	
TRP	5.5	1.3	63	3.5	68	3.7			
ILE	13.3	3.1	72	9.6	74	9.9	71	9.5	4.6
VAL	19.3	4.5	74	14.2	76	14.6	75	14.5	5.4
LEU	23.9	5.6	74	17.6	76	18.1	74	17.7	7.5
PHE	22.1	5.2	82	18.1	83	18.4	84	18.6	5.6
TYR	11.6	2.7	78	9.1	81	9.3	75	8.7	
PHE+TYR	33.7	7.9	81	27.2	82	27.8	81	27.3	
HIS	12.2	2.9	75	9.2	76	9.3	70	8.6	2.6
ARG	46.6	10.9	89	41.5	90	41.9	84	39.2	7.2
ALA	18.4	4.3	70	12.9	73	13.3			
ASP	38.8	9.1	78	30.4	80	31.0			
GLU	80.3	18.9	85	68.0	86	68.8			
GLY	17.5	4.1	71	12.3	73	12.7			
SER	18.1	4.2	76	13.7	78	14.1	67	12.1	
PRO	13.8	3.2	80	11.0	84	11.6			

Cottonseed meal, crude fibre 14-20%

By-product from the manufacture of cottonseed oil, obtained by solvent extraction of partially dehulled cottonseeds. This product contains 14% to 20% crude fibre (as fed)

Toasted cottonseed meal for ruminants: see page 293

All values are expressed on an as fed basis unless otherwise noted.

Main constituents	mean	sd	Fatty acids	%FA	g/kg
Dry matter (%)	90.1	1.3	Lauric acid C12:0	0.5	0.1
Crude protein (%)	36.3	2.9	Myristic acid C14:0	0.9	0.2
Crude fibre (%)	16.9	1.5	Palmitic acid C16:0	23.0	4.7
Ether extract (%)	2.7	1.2	Palmitoleic acid C16:1	0.9	0.2
Ash (%)	6.5	0.6	Stearic acid C18:0	2.4	0.5
Insoluble ash (%)	0.1		Oleic acid C18:1	17.2	3.5
Neutral detergent fibre (%)	31.8	5.2	Linoleic acid C18:2	52.3	10.7
Acid detergent fibre (%)	22.2	3.0	Linolenic acid C18:3	0.2	0.0
Acid detergent lignin (%)	6.8	1.5			
Water insoluble cell walls (%)	35.5	4.3	Fatty acids/ether extract (%)	75	
Starch (%)	0.0				
Total sugars (%)	2.4				
Gross energy (MJ/kg)	18.3	0.6			

Mineral elements	mean	sd
Calcium (g/kg)	2.4	0.9
Phosphorus (g/kg)	11.4	1.0
Phytate P / total P (%)	70	
Magnesium (g/kg)	5.6	0.5
Potassium (g/kg)	15.7	1.2
Sodium (g/kg)	0.8	
Chlorine (g/kg)	0.5	
Sulphur (mg/kg)	3.3	
DCAD (mEq/kg)	214	
EB (mEq/kg)	421	
Manganese (mg/kg)	15	
Zinc (mg/kg)	58	
Copper (mg/kg)	10	
Iron (mg/kg)	184	
Selenium (mg/kg)	0.54	
Cobalt (mg/kg)	0.52	
Molybdenum (mg/kg)	3	

Pigs	Growing	Sow	Poultry	Cockerel	Broiler
DE (MJ/kg)	12.1	12.9	AMEn (MJ/kg)	7.0	
ME (MJ/kg)	11.1	11.6	P availability (%)		
NE (MJ/kg)	6.4	6.9	Horses		
Ed (%)	66	71	UFC (per kg)		
OMd (%)	69	73	MADC (g/kg)		
Nd (%)	80	83	Rabbits		
EEd (%)		36	DE (MJ/kg)		
Pd (%)		26	MEEn (MJ/kg)		
Ruminants			Ed (%)		
UFL (per kg)		0.80	Nd (%)		
UFV (per kg)		0.73	Fish		
PDIA (g/kg)		135	DE (MJ/kg)		
PDIN (g/kg)		254	Ed (%)		
PDIE (g/kg)		173	Nd (%)		
ME (kcal/kg)		9.6			
Ed (%)		69			
OMd (%)		69			
Nd (%)		76			
TId (%)		86			
FAd (%)		70			
Absorbed phosphorus (g/kg)		7.3			
Ruminal degradation	Nitrogen	Starch	DM		
Effective degradability	61		52		
a (%)			28		
b (%)			51		
c (%/h)			5.5		

Amino acid content and digestibility

Amino acids	Total		Pigs				Poultry		Ruminants
	g/kg	% CP	AID %	AIDC g/kg	SID %	SIDC g/kg	TD %	TDC g/kg	AADI % PDIE
LYS	14.6	4.0					63	9.2	5.9
THR	11.6	3.2					69	8.0	4.6
MET	5.3	1.5					75	4.0	1.6
CYS	6.1	1.7					67	4.1	
MET+CYS	11.4	3.1					71	8.0	
TRP	4.7	1.3							
ILE	11.2	3.1					71	7.9	4.6
VAL	16.0	4.4					75	12.0	5.4
LEU	20.1	5.6					74	14.9	7.5
PHE	18.6	5.1					84	15.6	5.6
TYR	9.8	2.7					75	7.3	
PHE+TYR	28.4	7.8					81	23.0	
HIS	10.7	2.9					70	7.5	2.6
ARG	38.6	10.6					84	32.4	7.1
ALA	15.1	4.2							
ASP	33.1	9.1							
GLU	67.6	18.6							
GLY	14.5	4.0							
SER	15.5	4.3					67	10.4	
PRO	12.3	3.4							

Grapeseed oil meal, solvent extracted

By-product from the manufacture of grapeseed oil (*Vitis vinifera* L.), obtained by solvent extraction of grape seeds (n = 7).

All values are expressed on an as fed basis unless otherwise noted.

Main constituents	mean	sd	Fatty acids	%FA	g/kg
Dry matter (%)	87.4		Myristic acid C14:0	0.0	0.0
Crude protein (%)	9.8	1.0	Palmitic acid C16:0	6.8	0.5
Crude fibre (%)	41.9	6.4	Palmitoleic acid C16:1	0.2	0.0
Ether extract (%)	1.0	0.8	Stearic acid C18:0	3.3	0.3
Ash (%)	3.4	0.7	Oleic acid C18:1	15.8	1.2
Neutral detergent fibre (%)	69.1		Linoleic acid C18:2	68.5	5.3
Acid detergent fibre (%)	60.5		Linolenic acid C18:3	0.3	0.0
Acid detergent lignin (%)	46.0				
Starch (%)	0.0		Fatty acids/ether extract (%)	75	
Total sugars (%)	0.5				
Gross energy (MJ/kg)	17.0				

Mineral elements	mean	sd
Calcium (g/kg)	6.8	
Phosphorus (g/kg)	1.5	
Magnesium (g/kg)	0.6	
Potassium (g/kg)	5.9	
Sodium (g/kg)	0.3	
Manganese (mg/kg)	21	
Zinc (mg/kg)	15	
Copper (mg/kg)	21	
Iron (mg/kg)	167	
Selenium (mg/kg)	0.03	
Cobalt (mg/kg)	0.10	

Pigs			Growing	Sow	Poultry		Cockerel	Broiler
DE (MJ/kg)			5.4	6.4	AMEn (MJ/kg)			
ME (MJ/kg)			5.0	5.7	P availability (%)			
NE (MJ/kg)			2.3	2.7				
Ed (%)			32	38	Horses			
OMd (%)			37	43	UFC (per kg)			
Nd (%)			23	38	MADC (g/kg)			
EEd (%)				0				
Ruminants					Rabbits			
UFL (per kg)				0.17	DE (MJ/kg)		3.3	
UFV (per kg)				0.08	MEEn (MJ/kg)		3.2	
PDIA (g/kg)				9	Ed (%)		19	
PDIN (g/kg)				32	Nd (%)		0	
PDIE (g/kg)				18				
ME (kcal/kg)				2.4	Fish			
Ed (%)				18	DE (MJ/kg)			
OMd (%)				20	Ed (%)			
Nd (%)				35	Nd (%)			
TId (%)				15				
FAd (%)				56				
Absorbed phosphorus (g/kg)				1.0				
<i>Ruminal degradation</i>			<i>Nitrogen</i>	<i>Starch</i>	<i>DM</i>			
Effective degradability			47	15				
a (%)			10					
b (%)			66					
c (%/h)			8.0					

Amino acid content and digestibility

Amino acids	Total		Pigs				Poultry		Ruminants
	g/kg	% CP	AID %	AIDC g/kg	SID %	SIDC g/kg	TD %	TDC g/kg	AADI % PDIE
LYS	4.0	4.1							6.8
THR	2.0	2.0							4.6
MET	1.7	1.7							2.0
CYS	2.1	2.1							
MET+CYS	3.7	3.8							
TRP	0.9	1.0							
ILE	4.0	4.1							5.4
VAL	5.0	5.1							6.0
LEU	6.0	6.1							8.2
PHE	3.8	3.9							5.0
TYR	2.4	2.4							
PHE+TYR	6.2	6.3							
HIS	2.1	2.1							2.1
ARG	6.5	6.6							5.3
ALA	2.8	2.8							
ASP	6.5	6.6							
GLU	16.7	17.0							
GLY	6.2	6.3							
SER	2.8	2.8							
PRO	3.8	3.9							

Groundnut meal, detoxified, crude fibre < 9%

By-product from the manufacture of groundnut oil (*Arachis hypogaea* L.), obtained by solvent extraction of the seeds and treated with ammonia for mycotoxin decontamination. Crude fibre content is lower than 9% (as fed) (n = 515).

All values are expressed on an as fed basis unless otherwise noted.

Main constituents	mean	sd	Fatty acids	%FA	g/kg
Dry matter (%)	89.6	1.7	Myristic acid C14:0	0.1	0.0
Crude protein (%)	48.9	3.7	Palmitic acid C16:0	10.2	2.6
Crude fibre (%)	6.8	1.0	Palmitoleic acid C16:1	0.5	0.1
Ether extract (%)	3.4	2.3	Stearic acid C18:0	2.4	0.6
Ash (%)	6.0	0.9	Oleic acid C18:1	46.8	12.1
Insoluble ash (%)	1.7		Linoleic acid C18:2	29.8	7.7
Neutral detergent fibre (%)	14.3	5.8	Linolenic acid C18:3	0.8	0.2
Acid detergent fibre (%)	8.6	1.4	Arachidic acid C20:0	3.1	0.8
Acid detergent lignin (%)	2.5	1.6	Eicosenoic acid C20:1	1.4	0.4
Starch (%)	0.0		Behenic acid C22:0	2.9	0.7
Total sugars (%)	9.2		Lignoceric acid C24:0	1.4	0.4
Gross energy (MJ/kg)	18.5	0.7			
			Fatty acids/ether extract (%)	75	

Mineral elements	mean	sd	Vitamins	mean
Calcium (g/kg)	2.0	1.0	Vitamin E (mg/kg)	3
Phosphorus (g/kg)	5.6	0.7	Vitamin B1 - thiamin (mg/kg)	7
Phytate P / total P (%)	60		Vitamin B2 - riboflavin (mg/kg)	5
Magnesium (g/kg)	3.0		Vitamin B6 - pyridoxine (mg/kg)	7
Potassium (g/kg)	14.5		Vitamin B12 (µg/kg)	0
Sodium (g/kg)	0.1		Niacin (mg/kg)	162
Chlorine (g/kg)	1.0		Pantothenic acid (mg/kg)	46
Sulphur (mg/kg)	3.2		Folic acid (mg/kg)	0.68
DCAD (mEq/kg)	150		Biotin (mg/kg)	0.34
EB (mEq/kg)	349		Choline (%)	1799
Manganese (mg/kg)	35	10		
Zinc (mg/kg)	58			
Copper (mg/kg)	17			
Iron (mg/kg)	335			
Selenium (mg/kg)	0.10			
Cobalt (mg/kg)	0.28			
Molybdenum (mg/kg)	1.7			
Iodine (mg/kg)	0.44			

Pigs	Growing	Sow	Poultry	Cockerel	Broiler
DE (MJ/kg)	15.3	15.7	AMEn (MJ/kg)	10.1	10.0
ME (MJ/kg)	14.0	14.2	P availability (%)		10
NE (MJ/kg)	8.5	8.8	Horses		
Ed (%)	83	85	UFC (per kg)	0.91	
OMd (%)	84	86	MADC (g/kg)	440	
Nd (%)	90	91	Rabbits		
NSId (%)		77	DE (MJ/kg)		
EEEd (%)		55	MEEn (MJ/kg)		
Pd (%)		30	Ed (%)		
			Nd (%)		
Ruminants			Fish		
UFL (per kg)		1.00	DE (MJ/kg)		
UFV (per kg)		0.97	Ed (%)		
PDIA (g/kg)		168	Nd (%)		
PDIN (g/kg)		347			
PDIE (g/kg)		215			
ME (kcal/kg)		11.6			
Ed (%)		85			
OMd (%)		83			
Nd (%)		79			
TId (%)		94			
FAd (%)		72			
Absorbed phosphorus (g/kg)		3.7			
<i>Ruminal degradation</i>	<i>Nitrogen</i>	<i>Starch</i>	<i>DM</i>		
Effective degradability	67		63		
a (%)	16		23		
b (%)	80		66		
c (%/h)	10.5		9.0		

Amino acid content and digestibility

Amino acids	Total		Pigs				Poultry		Ruminants
	g/kg	% CP	AID	AIDC	SID	SIDC	TD	TDC	AADI
			%	g/kg	%	g/kg	%	g/kg	% PDIE
LYS	15.9	3.3	59	9.3	61	9.7			5.3
THR	13.0	2.7	69	8.9	71	9.2			4.3
MET	4.9	1.0	73	3.6	74	3.6			1.3
CYS	5.1	1.0	72	3.7	75	3.8			
MET+CYS	10.0	2.0	72	7.2	74	7.4			
TRP	5.6	1.1	70	3.9	72	4.0			
ILE	16.0	3.3	82	13.1	83	13.3			4.6
VAL	19.0	3.9	79	15.0	81	15.4			5.0
LEU	30.4	6.2	85	25.8	86	26.2			7.8
PHE	23.1	4.7	89	20.5	90	20.8			5.2
TYR	17.8	3.7	89	15.9	90	16.1			
PHE+TYR	41.0	8.4	89	36.4	90	36.9			
HIS	11.2	2.3							2.3
ARG	56.3	11.5	90	50.7	91	51.0			7.3
ALA	19.5	4.0	70	13.7	72	14.0			
ASP	55.5	11.4	84	46.4	85	47.0			
GLU	91.9	18.8	87	80.4	88	81.2			
GLY	27.5	5.6	68	18.7	69	19.1			
SER	22.8	4.7	75	17.1	76	17.4			
PRO	14.8	3.0	75	11.1	78	11.5			

Groundnut meal, detoxified, crude fibre > 9%

By-product from the manufacture of groundnut oil (*Arachis hypogaea* L.), obtained by solvent extraction of the seeds and treated with ammonia for mycotoxin decontamination. Crude fibre content is higher than 9% (as fed) (n = 962).

All values are expressed on an as fed basis unless otherwise noted.

Main constituents	mean	sd	Fatty acids	%FA	g/kg
Dry matter (%)	89.2	1.5	Myristic acid C14:0	0.1	0.0
Crude protein (%)	49.2	3.0	Palmitic acid C16:0	10.2	0.7
Crude fibre (%)	12.0	1.6	Palmitoleic acid C16:1	0.5	0.0
Ether extract (%)	0.9	1.0	Stearic acid C18:0	2.4	0.2
Ash (%)	5.9	0.6	Oleic acid C18:1	46.8	3.2
Insoluble ash (%)	0.8	0.2	Linoleic acid C18:2	29.8	2.0
Neutral detergent fibre (%)	20.1	3.5	Linolenic acid C18:3	0.8	0.1
Acid detergent fibre (%)	14.0	2.1	Arachidic acid C20:0	3.1	0.2
Acid detergent lignin (%)	4.6	0.9	Eicosenoic acid C20:1	1.4	0.1
Starch (%)	0.0		Behenic acid C22:0	2.9	0.2
Total sugars (%)	7.5		Lignoceric acid C24:0	1.4	0.1
Gross energy (MJ/kg)	18.0				
			Fatty acids/ether extract (%)	75	

Mineral elements	mean	sd	Vitamins	mean
Calcium (g/kg)	1.9	0.7	Vitamin E (mg/kg)	3
Phosphorus (g/kg)	5.6	0.5	Vitamin B1 - thiamin (mg/kg)	6
Phytate P / total P (%)	55		Vitamin B2 - riboflavin (mg/kg)	7
Magnesium (g/kg)	2.7	0.5	Vitamin B6 - pyridoxine (mg/kg)	6
Potassium (g/kg)	12.3	1.9	Vitamin B12 (µg/kg)	0
Sodium (g/kg)	1.9	1.8	Niacin (mg/kg)	170
Chlorine (g/kg)	1.0		Pantothenic acid (mg/kg)	47
Sulphur (mg/kg)	3.1		Folic acid (mg/kg)	0.52
DCAD (mEq/kg)	176		Biotin (mg/kg)	0.60
EB (mEq/kg)	370		Choline (%)	1752
Manganese (mg/kg)	33	6		
Zinc (mg/kg)	57	11		
Copper (mg/kg)	15	1.0		
Iron (mg/kg)	516	150		
Selenium (mg/kg)	0.16			
Cobalt (mg/kg)	0.27			
Molybdenum (mg/kg)	2			
Iodine (mg/kg)	0.06			

Pigs	Growing	Sow	Poultry	Cockerel	Broiler
DE (MJ/kg)	14.1	14.6	AMEn (MJ/kg)	9.1	9.0
ME (MJ/kg)	12.8	13.1	P availability (%)		10
NE (MJ/kg)	7.5	7.8	Horses		
Ed (%)	78	81	UFC (per kg)	0.86	
OMd (%)	79	82	MADC (g/kg)	427	
Nd (%)	90	92	Rabbits		
EEd (%)		0	DE (MJ/kg)		
Pd (%)		30	MEEn (MJ/kg)		
Ruminants			Ed (%)		
UFL (per kg)		0.94	Nd (%)		
UFV (per kg)		0.90	Fish		
PDIA (g/kg)		164	DE (MJ/kg)		
PDIN (g/kg)		343	Ed (%)		
PDIE (g/kg)		211	Nd (%)		
ME (kcal/kg)		10.9			
Ed (%)		83			
OMd (%)		82			
Nd (%)		79			
TId (%)		91			
FAd (%)		52			
Absorbed phosphorus (g/kg)		3.7			
Ruminal degradation	Nitrogen	Starch	DM		
Effective degradability	67		63		
a (%)			23		
b (%)			66		
c (%/h)			9.0		

Amino acid content and digestibility

Amino acids	Total		Pigs				Poultry		Ruminants
	g/kg	% CP	AID %	AIDC g/kg	SID %	SIDC g/kg	TD %	TDC g/kg	AADI % PDIE
LYS	16.0	3.3					78	12.5	5.3
THR	13.1	2.7					84	11.0	4.3
MET	4.9	1.0					87	4.3	1.3
CYS	4.5	0.9					78	3.5	
MET+CYS	9.4	1.9					83	7.8	
TRP	5.7	1.2							
ILE	16.0	3.3					87	14.0	4.6
VAL	19.1	3.9					88	16.8	5.0
LEU	30.5	6.2					90	27.5	7.8
PHE	23.3	4.7					91	21.2	5.2
TYR	18.0	3.7					91	16.4	
PHE+TYR	41.2	8.4					91	37.5	
HIS	11.2	2.3					89	10.0	2.3
ARG	56.6	11.5					89	50.4	7.3
ALA	19.6	4.0					89	17.4	
ASP	55.8	11.3					85	47.4	
GLU	92.5	18.8					92	85.1	
GLY	27.7	5.6					77	21.3	
SER	22.9	4.7					88	20.2	
PRO	14.8	3.0					89	13.2	

Linseed meal, expeller

By-product from the manufacture of linseed oil, obtained by mechanical extraction of linseeds (n = 292).

All values are expressed on an as fed basis unless otherwise noted.

Main constituents	mean	sd	Fatty acids	%FA	g/kg
Dry matter (%)	90.4	1.8	Myristic acid C14:0	0.1	0.1
Crude protein (%)	30.9	2.4	Palmitic acid C16:0	6.4	4.7
Crude fibre (%)	10.2	1.5	Palmitoleic acid C16:1	0.1	0.1
Ether extract (%)	8.1	2.2	Stearic acid C18:0	3.4	2.5
Ash (%)	5.9	0.7	Oleic acid C18:1	18.7	13.7
Insoluble ash (%)	0.6		Linoleic acid C18:2	14.7	10.7
Neutral detergent fibre (%)	23.4	3.4	Linolenic acid C18:3	54.2	39.6
Acid detergent fibre (%)	14.2	1.2			
Acid detergent lignin (%)	6.0	1.0	Fatty acids/ether extract (%)	90	
Starch (%)	0.0				
Total sugars (%)	3.5				
Gross energy (MJ/kg)	18.5	0.5			

Mineral elements	mean	sd	Vitamins	mean
Calcium (g/kg)	4.2	1.0	Vitamin E (mg/kg)	8
Phosphorus (g/kg)	8.2	0.8		
Phytate P / total P (%)	65			
Magnesium (g/kg)	5.0			
Potassium (g/kg)	11.7			
Sodium (g/kg)	0.8	0.3		
Chlorine (g/kg)	0.5			
Sulphur (mg/kg)	3.6			
DCAD (mEq/kg)	94			
EB (mEq/kg)	320			
Manganese (mg/kg)	39			
Zinc (mg/kg)	66			
Copper (mg/kg)	18			
Iron (mg/kg)	331			
Selenium (mg/kg)	0.45			
Cobalt (mg/kg)	0.43			
Molybdenum (mg/kg)	0.52			
Iodine (mg/kg)	0.31			

Pigs	Growing	Sow	Poultry	Cockerel	Broiler
DE (MJ/kg)	13.9	14.5	AMEn (MJ/kg)	5.6	
ME (MJ/kg)	12.8	13.2	P availability (%)		
NE (MJ/kg)	8.4	8.7	Horses		
Ed (%)	75	78	UFC (per kg)	0.85	
OMd (%)	77	80	MADC (g/kg)	250	
Nd (%)	86	89	Rabbits		
EEd (%)		68	DE (MJ/kg)		
Pd (%)		12	MEEn (MJ/kg)		
Ruminants			Ed (%)		
UFL (per kg)		0.97	Nd (%)		
UFV (per kg)		0.92	Fish		
PDIA (g/kg)		131	DE (MJ/kg)		
PDIN (g/kg)		220	Ed (%)		
PDIE (g/kg)		172	Nd (%)		
ME (kcal/kg)		11.2			
Ed (%)		78			
OMd (%)		78			
Nd (%)		77			
TId (%)		85			
FAd (%)		77			
Absorbed phosphorus (g/kg)		5.5			
Ruminal degradation	Nitrogen	Starch	DM		
Effective degradability	55		53		
a (%)			21		
b (%)			60		
c (%/h)			7.0		

Amino acid content and digestibility

Amino acids	Total		Pigs				Poultry		Ruminants
	g/kg	% CP	AID %	AIDC g/kg	SID %	SIDC g/kg	TD %	TDC g/kg	AADI % PDIE
LYS	11.7	3.8					81	9.4	5.6
THR	11.8	3.8					72	8.5	4.8
MET	5.4	1.7					83	4.4	1.8
CYS	6.0	1.9					68	4.1	
MET+CYS	11.3	3.7					75	8.5	
TRP	4.7	1.5							
ILE	12.9	4.2					84	10.8	5.0
VAL	14.9	4.8					82	12.2	5.5
LEU	17.6	5.7					84	14.7	7.4
PHE	14.9	4.8					88	13.1	5.1
TYR	7.2	2.3					83	6.0	
PHE+TYR	22.1	7.1					86	19.1	
HIS	8.3	2.7					85	7.1	2.4
ARG	27.8	9.0					93	25.9	6.2
ALA	14.1	4.6							
ASP	29.4	9.5							
GLU	60.7	19.6							
GLY	18.2	5.9							
SER	15.2	4.9					77	11.7	
PRO	11.4	3.7							

Linseed meal, solvent extracted

By-product from the manufacture of linseed oil, obtained by solvent extraction of linseeds (n = 39).

All values are expressed on an as fed basis unless otherwise noted.

Main constituents	mean	sd	Fatty acids	%FA	g/kg
Dry matter (%)	88.6	1.8	Myristic acid C14:0	0.1	0.0
Crude protein (%)	31.8	2.2	Palmitic acid C16:0	6.4	1.4
Crude fibre (%)	9.8	1.3	Palmitoleic acid C16:1	0.1	0.0
Ether extract (%)	3.0	1.1	Stearic acid C18:0	3.4	0.8
Ash (%)	5.8	0.7	Oleic acid C18:1	18.7	4.2
Insoluble ash (%)	1.9		Linoleic acid C18:2	14.7	3.3
Neutral detergent fibre (%)	22.8		Linolenic acid C18:3	54.2	12.3
Acid detergent fibre (%)	13.8				
Acid detergent lignin (%)	5.8		Fatty acids/ether extract (%)	75	
Starch (%)	0.0				
Total sugars (%)	4.5				
Gross energy (MJ/kg)	17.1				

Mineral elements	mean	sd	Vitamins	mean
Calcium (g/kg)	4.5	1.2	Vitamin E (mg/kg)	13
Phosphorus (g/kg)	8.0	0.9		
Phytate P / total P (%)	65			
Magnesium (g/kg)	4.3			
Potassium (g/kg)	10.3			
Sodium (g/kg)	1.0			
Chlorine (g/kg)	0.6			
Sulphur (mg/kg)	3.6			
DCAD (mEq/kg)	63			
EB (mEq/kg)	289			
Manganese (mg/kg)	43			
Zinc (mg/kg)	60			
Copper (mg/kg)	19			
Iron (mg/kg)	291			
Selenium (mg/kg)	0.66			
Cobalt (mg/kg)	0.37			
Molybdenum (mg/kg)	1.0			
Iodine (mg/kg)	0.90			

Pigs	Growing	Sow	Poultry	Cockerel	Broiler
DE (MJ/kg)	13.0	13.5	AMEn (MJ/kg)	5.7	
ME (MJ/kg)	11.9	12.2	P availability (%)		
NE (MJ/kg)	7.3	7.7	Horses		
Ed (%)	76	79	UFC (per kg)	0.78	
OMd (%)	78	81	MADC (g/kg)	258	
Nd (%)	88	90	Rabbits		
EEd (%)		46	DE (MJ/kg)		
Pd (%)		12	MEEn (MJ/kg)		
Ruminants			Ed (%)		
UFL (per kg)		0.88	Nd (%)		
UFV (per kg)		0.84	Fish		
PDIA (g/kg)		135	DE (MJ/kg)		
PDIN (g/kg)		227	Ed (%)		
PDIE (g/kg)		179	Nd (%)		
ME (kcal/kg)		10.3			
Ed (%)		77			
OMd (%)		78			
Nd (%)		77			
TId (%)		85			
FAd (%)		71			
Absorbed phosphorus (g/kg)		5.4			
<i>Ruminal degradation</i>	<i>Nitrogen</i>	<i>Starch</i>	<i>DM</i>		
Effective degradability	55		53		
a (%)	16		21		
b (%)	77		60		
c (%/h)	6.0		7.0		

Amino acid content and digestibility

Amino acids	Total		Pigs				Poultry		Ruminants
	g/kg	% CP	AID %	AIDC g/kg	SID %	SIDC g/kg	TD %	TDC g/kg	AADI % PDIE
LYS	11.9	3.7					81	9.7	5.6
THR	11.8	3.7					72	8.5	4.7
MET	5.4	1.7					83	4.5	1.8
CYS	6.1	1.9					68	4.2	
MET+CYS	11.6	3.6					75	8.7	
TRP	4.8	1.5							
ILE	13.0	4.1					84	10.9	5.0
VAL	15.1	4.7					82	12.4	5.5
LEU	17.7	5.6					84	14.9	7.3
PHE	15.0	4.7					88	13.2	5.1
TYR	7.2	2.3					83	6.0	
PHE+TYR	22.2	7.0					86	19.2	
HIS	8.7	2.7					85	7.4	2.4
ARG	27.9	8.8					93	25.9	6.2
ALA	14.6	4.6							
ASP	29.9	9.4							
GLU	62.7	19.7							
GLY	18.9	5.9							
SER	15.4	4.8					77	11.9	
PRO	11.8	3.7							

Palm kernel meal, expeller

By-product from the manufacture of palm kernel oil (*Elaeis guineensis* Jacq. or *Elaeis melanococca* auct.), obtained by mechanical extraction of palm kernels (n = 557).

All values are expressed on an as fed basis unless otherwise noted.

Main constituents	mean	sd	Fatty acids	%FA	g/kg
Dry matter (%)	90.6	1.6	Sum C6 + C8 + C10	7.8	6.0
Crude protein (%)	14.8	1.2	Lauric acid C12:0	46.9	35.8
Crude fibre (%)	17.9	2.9	Myristic acid C14:0	15.7	12.0
Ether extract (%)	8.5	1.5	Palmitic acid C16:0	8.5	6.5
Ash (%)	4.1	0.6	Stearic acid C18:0	2.6	2.0
Insoluble ash (%)	3.0	3.4	Oleic acid C18:1	14.9	11.4
Neutral detergent fibre (%)	65.8	5.1	Linoleic acid C18:2	2.2	1.7
Acid detergent fibre (%)	40.4	4.6	Linolenic acid C18:3	0.4	0.3
Acid detergent lignin (%)	12.1	2.7			
Water insoluble cell walls (%)	58.0	4.6	Fatty acids/ether extract (%)	90	
Starch (%)	0.0				
Total sugars (%)	2.0				
Gross energy (MJ/kg)	18.2	0.9			

Mineral elements	mean	sd
Calcium (g/kg)	2.8	0.7
Phosphorus (g/kg)	5.6	0.7
Phytate P / total P (%)	65	
Magnesium (g/kg)	2.9	0.7
Potassium (g/kg)	6.4	1.1
Sodium (g/kg)	0.3	0.4
Chlorine (g/kg)	1.5	
Sulphur (mg/kg)	2.2	
DCAD (mEq/kg)	-1.2	
EB (mEq/kg)	136	
Manganese (mg/kg)	131	73
Zinc (mg/kg)	32	20
Copper (mg/kg)	21	9
Iron (mg/kg)	534	
Selenium (mg/kg)	0.12	
Cobalt (mg/kg)	0.13	
Molybdenum (mg/kg)	0.40	
Iodine (mg/kg)	0.13	

Pigs	Growing	Sow	Poultry	Cockerel	Broiler
DE (MJ/kg)	7.7	9.1	AMEn (MJ/kg)		
ME (MJ/kg)	7.1	8.2	P availability (%)		
NE (MJ/kg)	4.9	5.6			
Ed (%)	42	50	Horses		
OMd (%)	47	54	UFC (per kg)	0.72	
Nd (%)	63	77	MADC (g/kg)	89	
NSId (%)		54			
EEEd (%)		59	Rabbits		
Pd (%)		31	DE (MJ/kg)	10.5	
			MEEn (MJ/kg)	10.0	
Ruminants			Ed (%)	58	
UFL (per kg)		0.84	Nd (%)	60	
UFV (per kg)		0.77			
PDIA (g/kg)		74	Fish		
PDIN (g/kg)		105	DE (MJ/kg)		
PDIE (g/kg)		113	Ed (%)		
ME (kcal/kg)		10.0	Nd (%)		
Ed (%)		68			
OMd (%)		68			
Nd (%)		71			
TId (%)		79			
FAd (%)		77			
Absorbed phosphorus (g/kg)		3.8			
Ruminal degradation	Nitrogen	Starch	DM		
Effective degradability	43	43			
a (%)	15	11			
b (%)	76	81			
c (%/h)	3.5	4.0			

Amino acid content and digestibility

Amino acids	Total		Pigs				Poultry		Ruminants
	g/kg	% CP	AID	AIDC	SID	SIDC	TD	TDC	AADI
			%	g/kg	%	g/kg	%	g/kg	% PDIE
LYS	4.0	2.7	30	1.2	37	1.5			5.6
THR	4.5	3.0	46	2.0	52	2.3			4.8
MET	2.6	1.8	65	1.7	68	1.8			1.9
CYS	1.7	1.1	40	0.7	47	0.8			
MET+CYS	4.2	2.9	54	2.3	59	2.5			
TRP	1.0	0.7	44	0.4	52	0.5			
ILE	5.1	3.5	62	3.2	66	3.4			5.0
VAL	7.4	5.0	62	4.6	66	4.8			6.0
LEU	8.8	6.0	66	5.8	70	6.1			8.1
PHE	5.7	3.9	71	4.0	75	4.3			4.8
TYR	3.0	2.1	61	1.9	67	2.0			
PHE+TYR	8.7	5.9	68	5.9	72	6.3			
HIS	2.6	1.8	56	1.5	61	1.6			2.1
ARG	16.5	11.2	76	12.6	78	12.9			7.2
ALA	5.8	3.9	57	3.3	62	3.6			
ASP	11.6	7.8	46	5.3	50	5.8			
GLU	26.6	18.1	61	16.3	63	16.9			
GLY	6.3	4.3	43	2.7	49	3.1			
SER	6.3	4.2	60	3.7	64	4.0			
PRO	4.3	2.9	40	1.7	51	2.2			

Rapeseed meal

By-product from the manufacture of rapeseed oil, obtained by solvent extraction of rapeseeds from low-erucic, low-glucosinolate ('00') varieties (n = 2820).

Extruded rapeseed meal and formaldehyde-treated rapeseed meal for ruminants: see page 293

All values are expressed on an as fed basis unless otherwise noted.

Main constituents	mean	sd	Fatty acids	%FA	g/kg
Dry matter (%)	88.7	1.3	Myristic acid C14:0	0.1	0.0
Crude protein (%)	33.7	1.3	Palmitic acid C16:0	4.2	0.8
Crude fibre (%)	12.4	1.3	Palmitoleic acid C16:1	0.4	0.1
Ether extract (%)	2.3	0.9	Stearic acid C18:0	1.8	0.3
Ash (%)	7.0	0.5	Oleic acid C18:1	58.0	10.7
Insoluble ash (%)	1.4		Linoleic acid C18:2	20.5	3.8
Neutral detergent fibre (%)	28.3	4.0	Linolenic acid C18:3	9.8	1.8
Acid detergent fibre (%)	19.6	2.0	Fatty acids/ether extract (%)	80	
Acid detergent lignin (%)	9.5	1.8			
Water insoluble cell walls (%)	32.7	4.1			
Starch (%)	0.0				
Total sugars (%)	7.7	1.8			
Gross energy (MJ/kg)	17.1	0.6			

Mineral elements	mean	sd	Vitamins	mean
Calcium (g/kg)	8.3	1.3	Vitamin E (mg/kg)	14
Phosphorus (g/kg)	11.4	0.9	Vitamin B1 - thiamin (mg/kg)	3
Phytate P / total P (%)	60		Vitamin B2 - riboflavin (mg/kg)	4
Magnesium (g/kg)	4.9	0.5	Vitamin B6 - pyridoxine (mg/kg)	11
Potassium (g/kg)	12.3	0.9	Vitamin B12 (µg/kg)	0
Sodium (g/kg)	0.4	0.1	Niacin (mg/kg)	166
Chlorine (g/kg)	0.7	0.2	Pantothenic acid (mg/kg)	9
Sulphur (mg/kg)	5.9		Folic acid (mg/kg)	0.82
DCAD (mEq/kg)	-53		Biotin (mg/kg)	0.90
EB (mEq/kg)	315		Choline (%)	6539
Manganese (mg/kg)	52	6		
Zinc (mg/kg)	65	17		
Copper (mg/kg)	7	6		
Iron (mg/kg)	172	44		
Selenium (mg/kg)	1.1	0.30		
Cobalt (mg/kg)	0.09			
Molybdenum (mg/kg)	1.6			
Iodine (mg/kg)	0.09			
			Other	mean
			Phytase activity (UI/kg)	10

Pigs	Growing	Sow	Poultry	Cockerel	Broiler
DE (MJ/kg)	11.6	12.4	AMEn (MJ/kg)	6.1	5.9
ME (MJ/kg)	10.6	11.2	P availability (%)		25
NE (MJ/kg)	6.3	6.8	Horses		
Ed (%)	68	73	UFC (per kg)	0.66	
OMd (%)	70	75	MADC (g/kg)	270	
Nd (%)	75	79	Rabbits		
NSId (%)		79	DE (MJ/kg)	11.2	
EEEd (%)		31	MEEn (MJ/kg)	9.9	
Pd (%)		32	Ed (%)	65	
Ruminants			Nd (%)	76	
UFL (per kg)		0.85	Fish		
UFV (per kg)		0.80	DE (MJ/kg)	10.5	
PDIA (g/kg)		92	Ed (%)	62	
PDIN (g/kg)		219	Nd (%)	82	
PDIE (g/kg)		138	Pd (%)	26	
ME (kcal/kg)		10.0			
Ed (%)		76			
OMd (%)		77			
Nd (%)		78			
TId (%)		79			
FAd (%)		69			
Absorbed phosphorus (g/kg)		8.1			
<i>Ruminal degradation</i>	<i>Nitrogen</i>	<i>Starch</i>	<i>DM</i>		
Effective degradability	69	60			
a (%)	27	28			
b (%)	67	55			
c (%/h)	10.0	8.5			

Amino acid content and digestibility

Amino acids	Total		Pigs				Poultry		Ruminants
	g/kg	% CP	AID	AIDC	SID	SIDC	TD	TDC	AADI
			%	g/kg	%	g/kg	%	g/kg	% PDIE
LYS	18.0	5.3	74	13.3	75	13.6	78	14.0	6.8
THR	14.5	4.3	72	10.5	75	10.8	84	12.2	5.1
MET	6.9	2.0	86	5.9	87	6.0	87	6.0	2.0
CYS	8.2	2.4	80	6.5	81	6.6	82	6.7	
MET+CYS	15.1	4.5	83	12.4	84	12.6	84	12.7	
TRP	4.1	1.2	77	3.1	80	3.3			
ILE	13.6	4.0	77	10.4	78	10.6	87	11.8	5.1
VAL	17.0	5.1	75	12.8	77	13.1	88	15.0	5.7
LEU	22.6	6.7	81	18.2	82	18.6	90	20.3	8.1
PHE	13.1	3.9	81	10.7	83	10.9	91	11.9	4.6
TYR	9.8	2.9	77	7.6	80	7.8	91	8.9	
PHE+TYR	23.0	6.8	80	18.3	82	18.8	91	20.9	
HIS	8.8	2.6	83	7.3	84	7.4	89	7.9	2.4
ARG	20.3	6.0	86	17.4	87	17.6	89	18.0	5.2
ALA	14.7	4.4	78	11.4	80	11.8	89	13.1	
ASP	23.9	7.1	74	17.7	76	18.2	85	20.3	
GLU	56.8	16.9	85	48.4	87	49.1	92	52.2	
GLY	16.7	5.0	76	12.6	78	13.0	83	13.9	
SER	14.9	4.4	76	11.2	78	11.5	88	13.1	
PRO	20.7	6.1	76	15.7	78	16.2	89	18.4	

Sesame meal, expeller

By-product from the manufacture of sesame oil (*Sesamum indicum* L.), obtained by mechanical extraction of sesame seeds (n = 26).

All values are expressed on an as fed basis unless otherwise noted.

Main constituents	mean	sd	Fatty acids	%FA	g/kg
Dry matter (%)	93.9	1.6	Myristic acid C14:0	0.1	0.1
Crude protein (%)	43.4	4.8	Palmitic acid C16:0	8.8	8.7
Crude fibre (%)	6.0	1.6	Palmitoleic acid C16:1	0.1	0.1
Ether extract (%)	11.0	3.1	Stearic acid C18:0	4.9	4.9
Ash (%)	11.4	2.2	Oleic acid C18:1	38.9	38.6
Insoluble ash (%)	2.2	1.6	Linoleic acid C18:2	43.7	43.4
Neutral detergent fibre (%)	18.9	1.4	Linolenic acid C18:3	0.4	0.4
Acid detergent fibre (%)	9.9	1.0	Fatty acids/ether extract (%)	90	
Acid detergent lignin (%)	1.8	0.1			
Starch (%)	0.0				
Total sugars (%)	3.4	0.3			
Gross energy (MJ/kg)	19.5	0.9			

Mineral elements	mean	sd	Vitamins	mean
Calcium (g/kg)	17.0	5.2	Vitamin E (mg/kg)	3
Phosphorus (g/kg)	11.8	3.4		
Phytate P / total P (%)	75			
Magnesium (g/kg)	5.5	0.6		
Potassium (g/kg)	9.7	0.6		
Sodium (g/kg)	0.1			
Chlorine (g/kg)	0.9	0.1		
Sulphur (mg/kg)	4.9			
DCAD (mEq/kg)	-80			
EB (mEq/kg)	225			
Manganese (mg/kg)	64			
Zinc (mg/kg)	125			
Copper (mg/kg)	34			
Iron (mg/kg)	1780	231		
Selenium (mg/kg)	0.21	0.04		
Cobalt (mg/kg)	0.71	0.22		
Molybdenum (mg/kg)	1.9	0.10		
Iodine (mg/kg)	0.17			

Pigs	Growing	Sow	Poultry	Cockerel	Broiler
DE (MJ/kg)	15.4	15.9	AMEn (MJ/kg)		
ME (MJ/kg)	14.1	14.4	P availability (%)		
NE (MJ/kg)	9.4	9.7			
Ed (%)	79	81	Horses		
OMd (%)	80	83	UFC (per kg)	0.74	
Nd (%)	91	92	MADC (g/kg)	387	
EEed (%)		73			
Pd (%)		29	Rabbits		
			DE (MJ/kg)		
Ruminants			MEEn (MJ/kg)		
UFL (per kg)		1.14	Ed (%)		
UFV (per kg)		1.12	Nd (%)		
PDIA (g/kg)		131			
PDIN (g/kg)		303	Fish		
PDIE (g/kg)		177	DE (MJ/kg)		
ME (kcal/kg)		12.9	Ed (%)		
Ed (%)		88	Nd (%)		
OMd (%)		88			
Nd (%)		80			
TId (%)		97			
FAd (%)		77			
Absorbed phosphorus (g/kg)		8.0			
<i>Ruminal degradation</i>	<i>Nitrogen</i>	<i>Starch</i>	<i>DM</i>		
Effective degradability	72		65		
a (%)	34				
b (%)	61				
c (%/h)	10.0				

Amino acid content and digestibility

Amino acids	Total		Pigs				Poultry		Ruminants
	g/kg	% CP	AID %	AIDC g/kg	SID %	SIDC g/kg	TD %	TDC g/kg	AADI % PDIE
LYS	10.2	2.3							5.0
THR	12.8	3.0							4.6
MET	11.2	2.6							2.4
CYS	7.7	1.8							
MET+CYS	18.9	4.4							
TRP	4.8	1.1							
ILE	14.5	3.3							4.8
VAL	18.6	4.3							5.5
LEU	27.0	6.2							8.1
PHE	18.4	4.2							5.1
TYR	13.4	3.1							
PHE+TYR	31.8	7.3							
HIS	9.7	2.2							2.3
ARG	44.6	10.3							7.0
ALA	19.0	4.4							
ASP	31.3	7.2							
GLU	74.4	17.1							
GLY	19.9	4.6							
SER	15.8	3.6							
PRO	14.1	3.2							

Soybean meal, 46

By-product from the manufacture of soybean oil, obtained by solvent extraction and heat treatment of soybeans, with partial reintroduction of the hulls. This product should contain about 46% (as fed) of protein + fat (n = 316).

Extruded soybean meal and formaldehyde-treated soybean meal for ruminants: see page 293

All values are expressed on an as fed basis unless otherwise noted.

Main constituents	mean	sd	Fatty acids	%FA	g/kg
Dry matter (%)	87.6	0.7	Myristic acid C14:0	0.1	0.0
Crude protein (%)	43.3	1.4	Palmitic acid C16:0	10.5	1.3
Crude fibre (%)	6.1	0.7	Palmitoleic acid C16:1	0.2	0.0
Ether extract (%)	1.7	0.5	Stearic acid C18:0	3.8	0.5
Ash (%)	6.5	0.7	Oleic acid C18:1	21.7	2.8
Insoluble ash (%)	0.2		Linoleic acid C18:2	53.1	6.8
Neutral detergent fibre (%)	12.4	1.0	Linolenic acid C18:3	7.4	0.9
Acid detergent fibre (%)	7.4	1.0			
Acid detergent lignin (%)	0.4	0.1	Fatty acids/ether extract (%)	75	
Water insoluble cell walls (%)	19.2				
Starch (%)	0.0				
Total sugars (%)	8.5				
Gross energy (MJ/kg)	17.1				

Mineral elements	mean	sd	Vitamins	mean
Calcium (g/kg)	3.4	0.9	Vitamin E (mg/kg)	5
Phosphorus (g/kg)	6.2	0.6	Vitamin B1 - thiamin (mg/kg)	3
Magnesium (g/kg)	2.9		Vitamin B2 - riboflavin (mg/kg)	3
Potassium (g/kg)	21.2		Vitamin B6 - pyridoxine (mg/kg)	7
Sodium (g/kg)	0.04		Vitamin B12 (µg/kg)	0
Chlorine (g/kg)	0.4		Niacin (mg/kg)	40
EB (mEq/kg)	536		Pantothenic acid (mg/kg)	15
Manganese (mg/kg)	35		Biotin (mg/kg)	0.35
			Choline (%)	2789

Pigs	Growing	Sow	Poultry	Cockerel	Broiler
DE (MJ/kg)	14.5	15.4	AMEn (MJ/kg)	9.4	9.2
ME (MJ/kg)	13.3	13.9	P availability (%)		22
NE (MJ/kg)	8.0	8.7	Horses		
Ed (%)	85	90	UFC (per kg)	0.80	
OMd (%)	86	91	MADC (g/kg)	386	
Nd (%)	87	90	Rabbits		
NSId (%)		87	DE (MJ/kg)	13.7	
EEed (%)		31	MEEn (MJ/kg)	11.9	
Ruminants			Ed (%)	80	
UFL (per kg)		1.05	Nd (%)	83	
UFV (per kg)		1.04	Fish		
PDIA (g/kg)		169	DE (MJ/kg)		
PDIN (g/kg)		316	Ed (%)		
PDIE (g/kg)		222	Nd (%)		
ME (kcal/kg)		11.8	Nd extruded (%)		
Ed (%)		92	Pd (%)		
OMd (%)		92			
Nd (%)		80			
TId (%)		95			
FAd (%)		65			
Absorbed phosphorus (g/kg)		4.4			
Ruminal degradation	Nitrogen	Starch			
Effective degradability	63				
a (%)					26
b (%)					71
c (%/h)					8.0

Amino acid content and digestibility

Amino acids	Total		Pigs				Poultry		Ruminants
	g/kg	% CP	AID	AIDC	SID	SIDC	TD	TDC	AADI
			%	g/kg	%	g/kg	%	g/kg	% PDIE
LYS	26.6	6.1	87	23.2	90	23.8			6.9
THR	17.0	3.9	82	13.9	86	14.7			4.8
MET	6.2	1.4	88	5.5	91	5.7			1.6
CYS	6.5	1.5	82	5.3	86	5.6			
MET+CYS	12.7	2.9	85	10.7	89	11.2			
TRP	5.6	1.3	84	4.7	89	5.0			
ILE	19.9	4.6	87	17.3	89	17.8			5.2
VAL	20.8	4.8	85	17.6	88	18.4			5.4
LEU	31.9	7.4	86	27.6	89	28.5			8.2
PHE	21.7	5.0	88	19.1	90	19.7			5.2
TYR	14.6	3.4	88	12.9	91	13.3			
PHE+TYR	36.3	8.4	88	32.0	91	33.0			
HIS	11.5	2.7	88	10.2	91	10.4			2.4
ARG	32.0	7.4	92	29.5	94	30.1			5.6
ALA	19.0	4.4	82	15.5	86	16.3			
ASP	49.0	11.3	87	42.6	89	43.8			
GLU	77.1	17.8	88	67.7	90	69.3			
GLY	18.1	4.2	79	14.3	84	15.3			
SER	21.8	5.0	86	18.7	89	19.4			
PRO	21.6	5.0							

Soybean meal, 48

By-product from the manufacture of soybean oil, obtained by solvent extraction and heat treatment of soybeans, with partial reintroduction of the hulls. This product should contain about 48% (as fed) of protein + fat (n = 10409).

Extruded soybean meal and formaldehyde-treated soybean meal for ruminants: see page 293

All values are expressed on an as fed basis unless otherwise noted.

Main constituents	mean	sd	Fatty acids	%FA	g/kg
Dry matter (%)	87.8	0.6	Myristic acid C14:0	0.1	0.0
Crude protein (%)	45.3	1.0	Palmitic acid C16:0	10.5	1.5
Crude fibre (%)	6.0	0.5	Palmitoleic acid C16:1	0.2	0.0
Ether extract (%)	1.9	0.4	Stearic acid C18:0	3.8	0.5
Ash (%)	6.4	0.5	Oleic acid C18:1	21.7	3.0
Insoluble ash (%)	0.3	0.3	Linoleic acid C18:2	53.1	7.4
Neutral detergent fibre (%)	12.2	1.7	Linolenic acid C18:3	7.4	1.0
Acid detergent fibre (%)	7.3	1.9			
Acid detergent lignin (%)	0.7	0.4	Fatty acids/ether extract (%)	75	
Water insoluble cell walls (%)	19.1	2.3			
Starch (%)	0.0				
Total sugars (%)	8.3	1.1			
Gross energy (MJ/kg)	17.3	0.5			

Mineral elements	mean	sd	Vitamins	mean
Calcium (g/kg)	3.4	0.9	Vitamin E (mg/kg)	4
Phosphorus (g/kg)	6.2	0.5	Vitamin B1 - thiamin (mg/kg)	6
Phytate P / total P (%)	60		Vitamin B2 - riboflavin (mg/kg)	3
Magnesium (g/kg)	2.9	0.3	Vitamin B6 - pyridoxine (mg/kg)	6
Potassium (g/kg)	21.1	1.5	Niacin (mg/kg)	39
Sodium (g/kg)	0.3	0.5	Pantothenic acid (mg/kg)	16
Chlorine (g/kg)	0.5	0.9	Folic acid (mg/kg)	0.59
Sulphur (mg/kg)	4.0		Biotin (mg/kg)	0.27
DCAD (mEq/kg)	289		Choline (%)	2545
EB (mEq/kg)	539			
Manganese (mg/kg)	38	11		
Zinc (mg/kg)	47	8		
Copper (mg/kg)	18	7		
Iron (mg/kg)	283	145		
Selenium (mg/kg)	0.20			
Cobalt (mg/kg)	0.26			
Molybdenum (mg/kg)	4			
Iodine (mg/kg)	0.15			

Other	mean
Phytase activity (U/kg)	20

Pigs	Growing	Sow	Poultry	Cockerel	Broiler
DE (MJ/kg)	14.7	15.6	AMEn (MJ/kg)	9.5	9.3
ME (MJ/kg)	13.4	14.1	P availability (%)		22
NE (MJ/kg)	8.1	8.7	Horses		
Ed (%)	85	90	UFC (per kg)	0.80	
OMd (%)	86	91	MADC (g/kg)	407	
Nd (%)	87	90	Rabbits		
NSId (%)		88	DE (MJ/kg)	13.8	
EEEd (%)		36	MEEn (MJ/kg)	11.9	
Pd (%)		32	Ed (%)	80	
Ruminants			Nd (%)	83	
UFL (per kg)		1.06	Fish		
UFV (per kg)		1.05	DE (MJ/kg)	13.0	
PDIA (g/kg)		177	Ed (%)	75	
PDIN (g/kg)		331	Nd (%)	86	
PDIE (g/kg)		229	Nd extruded (%)	97	
ME (kcal/kg)		11.9	Pd (%)	26	
Ed (%)		92			
OMd (%)		92			
Nd (%)		80			
TId (%)		95			
FAd (%)		66			
Absorbed phosphorus (g/kg)		4.4			
Ruminal degradation	Nitrogen	Starch	DM		
Effective degradability	63		67		
a (%)			26		
b (%)			71		
c (%/h)			8.0		

Amino acid content and digestibility

Amino acids	Total		Pigs				Poultry		Ruminants
	g/kg	% CP	AId	AIDC	SID	SIDC	TD	TDC	AADI % PDIE
LYS	27.8	6.1	87	24.2	90	24.9	91	25.3	6.9
THR	17.7	3.9	82	14.5	87	15.3	89	15.8	4.7
MET	6.4	1.4	88	5.7	92	5.9	91	5.8	1.5
CYS	6.7	1.5	82	5.5	86	5.8	86	5.7	
MET+CYS	13.1	2.9	85	11.1	89	11.6	88	11.5	
TRP	5.9	1.3	85	5.0	89	5.2			
ILE	20.9	4.6	87	18.1	90	18.7	92	19.2	5.2
VAL	21.8	4.8	85	18.5	88	19.3	91	19.8	5.4
LEU	33.4	7.4	87	28.9	89	29.8	92	30.7	8.2
PHE	22.8	5.0	88	20.0	91	20.6	93	21.2	5.2
TYR	15.1	3.3	88	13.4	92	13.9	93	14.0	
PHE+TYR	37.9	8.4	88	33.4	91	34.5	93	35.2	
HIS	12.0	2.7	88	10.6	91	10.9	93	11.1	2.4
ARG	33.6	7.4	92	31.0	94	31.6	92	31.0	5.6
ALA	19.9	4.4	82	16.2	86	17.1	89	17.6	
ASP	51.4	11.3	87	44.8	90	46.1	91	47.0	
GLU	80.8	17.8	88	71.2	90	72.8	94	76.1	
GLY	19.0	4.2	79	15.0	85	16.0	85	16.1	
SER	22.8	5.0	86	19.6	89	20.3	92	21.0	
PRO	22.4	4.9	87	19.5	90	20.1	93	20.8	

Soybean meal, 50

By-product from the manufacture of soybean oil, obtained by solvent extraction and heat treatment of dehulled soybeans. This product should contain about 50% (as fed) of protein + fat (n = 1453).

Extruded soybean meal and formaldehyde-treated soybean meal for ruminants: see page 293

All values are expressed on an as fed basis unless otherwise noted.

Main constituents	mean	sd	Fatty acids	%FA	g/kg
Dry matter (%)	87.6	1.0	Myristic acid C14:0	0.1	0.0
Crude protein (%)	47.2	1.5	Palmitic acid C16:0	10.5	1.2
Crude fibre (%)	3.9	0.5	Palmitoleic acid C16:1	0.2	0.0
Ether extract (%)	1.5	0.5	Stearic acid C18:0	3.8	0.4
Ash (%)	6.3	0.5	Oleic acid C18:1	21.7	2.5
Insoluble ash (%)	0.3	0.4	Linoleic acid C18:2	53.1	6.0
Neutral detergent fibre (%)	8.9	1.3	Linolenic acid C18:3	7.4	0.8
Acid detergent fibre (%)	4.8	0.7			
Acid detergent lignin (%)	0.4	0.3	Fatty acids/ether extract (%)	75	
Water insoluble cell walls (%)	15.9				
Starch (%)	0.0				
Total sugars (%)	9.2	0.8			
Gross energy (MJ/kg)	17.2	0.3			

Mineral elements	mean	sd	Vitamins	mean
Calcium (g/kg)	3.4	0.6	Vitamin E (mg/kg)	4
Phosphorus (g/kg)	6.2	0.5	Vitamin B1 - thiamin (mg/kg)	3
Phytate P / total P (%)	60		Vitamin B2 - riboflavin (mg/kg)	3
Magnesium (g/kg)	2.9		Vitamin B6 - pyridoxine (mg/kg)	6
Potassium (g/kg)	21.0		Vitamin B12 (µg/kg)	0
Sodium (g/kg)	0.3		Niacin (mg/kg)	22
Chlorine (g/kg)	0.9	0.9	Pantothenic acid (mg/kg)	14
Sulphur (mg/kg)	4.2		Folic acid (mg/kg)	0.68
DCAD (mEq/kg)	262		Biotin (mg/kg)	0.33
EB (mEq/kg)	523		Choline (%)	2709
Manganese (mg/kg)	34			
Zinc (mg/kg)	47			
Copper (mg/kg)	17			
Iron (mg/kg)	178			
Selenium (mg/kg)	0.21			
Cobalt (mg/kg)	0.10			
Molybdenum (mg/kg)	3			
Iodine (mg/kg)	0.25			
			Other	mean
			Phytase activity (UI/kg)	20

Pigs	Growing	Sow	Poultry	Cockerel	Broiler
DE (MJ/kg)	15.1	15.9	AMEn (MJ/kg)	9.9	9.7
ME (MJ/kg)	13.8	14.3	P availability (%)		22
NE (MJ/kg)	8.4	8.9	Horses		
Ed (%)	88	92	UFC (per kg)	0.79	
OMd (%)	88	93	MADC (g/kg)	425	
Nd (%)	90	93	Rabbits		
NSId (%)		90	DE (MJ/kg)	14.6	
EEd (%)		29	MEEn (MJ/kg)	12.6	
Pd (%)		32	Ed (%)	84	
Ruminants			Nd (%)	84	
UFL (per kg)		1.06	Fish		
UFV (per kg)		1.06	DE (MJ/kg)	12.9	
PDIA (g/kg)		186	Ed (%)	75	
PDIN (g/kg)		346	Nd (%)	95	
PDIE (g/kg)		238	Pd (%)		
ME (kcal/kg)		11.9			
Ed (%)		93			
OMd (%)		93			
Nd (%)		80			
TId (%)		96			
FAd (%)		63			
Absorbed phosphorus (g/kg)		4.4			
<i>Ruminal degradation</i>	<i>Nitrogen</i>	<i>Starch</i>	<i>DM</i>		
Effective degradability	63		67		
a (%)	13		26		
b (%)	85		71		
c (%/h)	8.5		8.0		

Amino acid content and digestibility

Amino acids	Total		Pigs				Poultry		Ruminants
	g/kg	% CP	AID	AIDC	SID	SIDC	TD	TDC	AADI
			%	g/kg	%	g/kg	%	g/kg	% PDIE
LYS	28.9	6.1	89	25.8	92	26.5	91	26.4	6.9
THR	18.3	3.9	84	15.5	89	16.3	89	16.4	4.7
MET	6.6	1.4	90	5.9	93	6.1	91	6.0	1.5
CYS	6.9	1.5	84	5.8	89	6.1	86	5.9	
MET+CYS	13.5	2.9	87	11.7	91	12.2	88	11.9	
TRP	6.1	1.3	87	5.3	91	5.6			
ILE	21.7	4.6	89	19.3	91	19.9	92	20.0	5.2
VAL	22.8	4.8	86	19.7	90	20.5	91	20.6	5.4
LEU	34.7	7.3	88	30.7	91	31.6	92	32.0	8.2
PHE	23.7	5.0	90	21.3	92	22.0	93	22.1	5.2
TYR	15.6	3.3	90	14.1	93	14.5	93	14.5	
PHE+TYR	39.4	8.3	90	35.4	93	36.4	93	36.6	
HIS	12.5	2.7	90	11.3	92	11.6	93	11.6	2.4
ARG	35.0	7.4	94	32.7	95	33.3	92	32.3	5.6
ALA	20.7	4.4	84	17.4	88	18.3	89	18.3	
ASP	53.7	11.4	89	47.8	91	49.0	91	49.1	
GLU	84.3	17.8	91	76.6	93	78.3	94	79.3	
GLY	19.7	4.2	84	16.5	90	17.7	85	16.7	
SER	23.6	5.0	88	20.8	91	21.6	92	21.8	
PRO	23.2	4.9	90	20.7	92	21.2	93	21.5	

Sunflower meal, partially decorticated

By-product from the manufacture of sunflower oil, obtained by solvent extraction of partially or completely dehulled seeds (n = 1141).

Toasted sunflower meal and formaldehyde-treated sunflower meal for ruminants: see page 293

All values are expressed on an as fed basis unless otherwise noted.

Main constituents	mean	sd	Fatty acids	%FA	g/kg
Dry matter (%)	89.7	1.2	Myristic acid C14:0	0.2	0.0
Crude protein (%)	33.4	2.2	Palmitic acid C16:0	6.3	0.8
Crude fibre (%)	21.2	2.0	Palmitoleic acid C16:1	0.4	0.1
Ether extract (%)	1.7	0.6	Stearic acid C18:0	4.3	0.6
Ash (%)	6.7	0.5	Oleic acid C18:1	20.3	2.6
Insoluble ash (%)	0.3	0.5	Linoleic acid C18:2	64.9	8.4
Neutral detergent fibre (%)	35.9	3.6	Linolenic acid C18:3	0.3	0.0
Acid detergent fibre (%)	24.7	2.4			
Acid detergent lignin (%)	8.2	1.2	Fatty acids/ether extract (%)	75	
Water insoluble cell walls (%)	38.5				
Starch (%)	0.0				
Total sugars (%)	5.7	0.7			
Gross energy (MJ/kg)	17.4	0.4			

Mineral elements	mean	sd	Vitamins	mean
Calcium (g/kg)	4.1	0.8	Vitamin E (mg/kg)	11
Phosphorus (g/kg)	10.8	1.7	Vitamin B1 - thiamin (mg/kg)	3
Phytate P / total P (%)	85		Vitamin B2 - riboflavin (mg/kg)	3
Magnesium (g/kg)	5.5	0.3	Vitamin B6 - pyridoxine (mg/kg)	13
Potassium (g/kg)	16.2	1.0	Niacin (mg/kg)	233
Sodium (g/kg)	0.1	0.1	Pantothenic acid (mg/kg)	39
Chlorine (g/kg)	1.4		Choline (%)	2538
Sulphur (mg/kg)	3.3			
DCAD (mEq/kg)	177			
EB (mEq/kg)	381			
Manganese (mg/kg)	48			
Zinc (mg/kg)	69			
Copper (mg/kg)	62			
Iron (mg/kg)	207			
Selenium (mg/kg)	0.49			
Cobalt (mg/kg)	0.13			
Molybdenum (mg/kg)	1.6			
Iodine (mg/kg)	0.09			
			Other	mean
			Phytase activity (UI/kg)	0

Pigs	Growing	Sow	Poultry	Cockerel	Broiler
DE (MJ/kg)	10.2	11.3	AMEn (MJ/kg)	6.3	6.2
ME (MJ/kg)	9.3	10.2	P availability (%)		17
NE (MJ/kg)	5.3	5.9	Horses		
Ed (%)	59	65	UFC (per kg)	0.57	
OMd (%)	62	68	MADC (g/kg)	261	
Nd (%)	74	79	Rabbits		
NSId (%)		82	DE (MJ/kg)	10.4	
EEEd (%)		4	MEEn (MJ/kg)	9.0	
Pd (%)		19	Ed (%)	60	
Ruminants			Nd (%)	81	
UFL (per kg)		0.66	Fish		
UFV (per kg)		0.57	DE (MJ/kg)		
PDIA (g/kg)		76	Ed (%)		
PDIN (g/kg)		219	Nd (%)		
PDIE (g/kg)		115			
ME (kcal/kg)		8.1			
Ed (%)		61			
OMd (%)		62			
Nd (%)		75			
TId (%)		89			
FAd (%)		65			
Absorbed phosphorus (g/kg)		7.1			
<i>Ruminal degradation</i>	<i>Nitrogen</i>	<i>Starch</i>	<i>DM</i>		
Effective degradability	77	60			
a (%)	33	34			
b (%)	60	44			
c (%/h)	16.0	8.5			

Amino acid content and digestibility

Amino acids	Total		Pigs				Poultry		Ruminants
	g/kg	% CP	AID	AIDC	SID	SIDC	TD	TDC	AADI % PDIE
LYS	11.8	3.5	80	9.4	82	9.7	83	9.8	5.8
THR	12.0	3.6	79	9.5	81	9.8	87	10.5	4.8
MET	7.6	2.3	90	6.9	92	7.0	93	7.1	2.1
CYS	5.8	1.7	80	4.6	82	4.7	84	4.8	
MET+CYS	13.4	4.0	86	11.5	88	11.7	89	11.9	
TRP	4.1	1.2	82	3.4	84	3.5			
ILE	13.6	4.1	83	11.2	85	11.5	91	12.4	5.1
VAL	16.4	4.9	81	13.3	83	13.6	90	14.8	5.6
LEU	20.6	6.2	83	17.2	85	17.6	90	18.6	7.8
PHE	14.6	4.4	85	12.5	87	12.8	92	13.5	4.9
TYR	7.5	2.2	86	6.5	89	6.7	89	6.7	
PHE+TYR	22.2	6.6	86	19.0	88	19.5	91	20.2	
HIS	8.1	2.4	82	6.6	84	6.7	89	7.2	2.3
ARG	27.4	8.2	92	25.3	93	25.5	93	25.5	5.8
ALA	14.6	4.4	79	11.5	82	11.9	86	12.5	
ASP	29.8	8.9	82	24.4	84	25.0	89	26.5	
GLU	65.5	19.6	89	58.4	90	59.1	94	61.6	
GLY	19.0	5.7	71	13.6	73	14.0	82	15.6	
SER	14.3	4.3	80	11.4	82	11.7	88	12.6	
PRO	14.6	4.4	84	12.3	87	12.8	90	13.2	

Sunflower meal, undecorticated

By-product from the manufacture of sunflower oil, obtained by solvent extraction of whole seeds (n = 2729).

Toasted sunflower meal and formaldehyde-treated sunflower meal for ruminants: see page 293

All values are expressed on an as fed basis unless otherwise noted.

Main constituents	mean	sd	Fatty acids	%FA	g/kg
Dry matter (%)	88.7	1.4	Myristic acid C14:0	0.2	0.0
Crude protein (%)	27.7	2.2	Palmitic acid C16:0	6.3	1.0
Crude fibre (%)	25.5	2.6	Palmitoleic acid C16:1	0.4	0.1
Ether extract (%)	2.0	0.8	Stearic acid C18:0	4.3	0.7
Ash (%)	6.2	0.6	Oleic acid C18:1	20.3	3.1
Insoluble ash (%)	0.6	1.1	Linoleic acid C18:2	64.9	9.9
Neutral detergent fibre (%)	41.1	3.7	Linolenic acid C18:3	0.3	0.0
Acid detergent fibre (%)	29.3	3.0			
Acid detergent lignin (%)	10.1	1.4	Fatty acids/ether extract (%)	75	
Water insoluble cell walls (%)	45.0	3.8			
Starch (%)	0.0				
Total sugars (%)	5.2	0.8			
Gross energy (MJ/kg)	17.2	0.5			

Mineral elements	mean	sd	Vitamins	mean
Calcium (g/kg)	3.9	0.8	Vitamin E (mg/kg)	12
Phosphorus (g/kg)	10.1	1.4	Vitamin B1 - thiamin (mg/kg)	33
Phytate P / total P (%)	85		Vitamin B2 - riboflavin (mg/kg)	3
Magnesium (g/kg)	5.1	0.8	Vitamin B6 - pyridoxine (mg/kg)	13
Potassium (g/kg)	15.1	1.6	Vitamin B12 (µg/kg)	0
Sodium (g/kg)	0.2	0.3	Niacin (mg/kg)	197
Chlorine (g/kg)	1.4	0.3	Pantothenic acid (mg/kg)	10
Sulphur (mg/kg)	3.4		Folic acid (mg/kg)	0.41
DCAD (mEq/kg)	141		Biotin (mg/kg)	1.2
EB (mEq/kg)	355		Choline (%)	2465
Manganese (mg/kg)	27	10		
Zinc (mg/kg)	92	11		
Copper (mg/kg)	27	2		
Iron (mg/kg)	243			
Selenium (mg/kg)	0.51			
Cobalt (mg/kg)	0.14			
Molybdenum (mg/kg)	0.70			
Iodine (mg/kg)	0.09			

Other	mean
Phytase activity (UI/kg)	0

Pigs	Growing	Sow	Poultry	Cockerel	Broiler
DE (MJ/kg)	9.0	10.3	AMEn (MJ/kg)	5.7	5.5
ME (MJ/kg)	8.2	9.2	P availability (%)		17
NE (MJ/kg)	4.6	5.2	Horses		
Ed (%)	52	60	UFC (per kg)	0.52	
OMd (%)	56	63	MADC (g/kg)	210	
Nd (%)	70	77	Rabbits		
NSId (%)		81	DE (MJ/kg)	9.4	
EEEd (%)		11	MEEn (MJ/kg)	8.3	
Pd (%)		19	Ed (%)	55	
Ruminants			Nd (%)	77	
UFL (per kg)		0.56	Fish		
UFV (per kg)		0.46	DE (MJ/kg)		
PDIA (g/kg)		59	Ed (%)		
PDIN (g/kg)		178	Nd (%)		
PDIE (g/kg)		93			
ME (kcal/kg)		7.0			
Ed (%)		53			
OMd (%)		54			
Nd (%)		71			
TId (%)		84			
FAd (%)		67			
Absorbed phosphorus (g/kg)		6.6			
Ruminal degradation	Nitrogen	Starch	DM		
Effective degradability	77		51		
a (%)			22		
b (%)			46		
c (%/h)			10.5		

Amino acid content and digestibility

Amino acids	Total		Pigs				Poultry		Ruminants
	g/kg	% CP	AID	AIDC	SID	SIDC	TD	TDC	AADI % PDIE
LYS	10.0	3.6	77	7.7	80	8.0	83	8.3	5.9
THR	10.0	3.6	79	7.9	82	8.2	87	8.7	4.9
MET	6.4	2.3	91	5.8	92	5.8	93	5.9	2.1
CYS	4.8	1.7	78	3.7	81	3.9	84	4.0	
MET+CYS	11.2	4.0	86	9.6	88	9.8	89	9.9	
TRP	3.4	1.2	83	2.8	85	2.9			
ILE	11.3	4.1	84	9.5	86	9.7	91	10.3	5.1
VAL	13.5	4.9	82	11.0	84	11.3	90	12.1	5.6
LEU	17.0	6.1	85	14.4	87	14.8	90	15.3	7.8
PHE	12.1	4.4	88	10.7	90	10.9	92	11.1	4.9
TYR	6.5	2.3	88	5.7	92	5.9	89	5.8	
PHE+TYR	18.6	6.7	88	16.4	91	16.8	91	16.9	
HIS	6.7	2.4	84	5.6	86	5.8	89	6.0	2.3
ARG	22.6	8.1	94	21.2	95	21.4	93	21.0	5.8
ALA	12.3	4.4	80	9.8	83	10.1	86	10.5	
ASP	24.4	8.8	83	20.2	85	20.7	89	21.7	
GLU	52.7	19.0	90	47.4	91	48.1	94	49.5	
GLY	15.9	5.7	70	11.1	72	11.5	82	13.0	
SER	12.0	4.3	80	9.5	82	9.8	88	10.5	
PRO	12.1	4.4	83	10.0	87	10.5	90	10.9	

Cassava, starch 67%

Dried cassava root (*Manihot esculenta* Crantz), containing 61-72% starch (as fed) (n = 755).
All values are expressed on an as fed basis unless otherwise noted.

Main constituents	mean	sd	Fatty acids	%FA	g/kg
Dry matter (%)	88.0	1.1	Sum C6 + C8 + C10	0.6	0.0
Crude protein (%)	2.7	0.5	Lauric acid C12:0	3.9	0.2
Crude fibre (%)	4.4	1.0	Myristic acid C14:0	1.7	0.1
Ether extract (%)	0.7	0.3	Palmitic acid C16:0	31.9	1.7
Ash (%)	5.5	0.9	Palmitoleic acid C16:1	0.7	0.0
Insoluble ash (%)	2.7	1.0	Stearic acid C18:0	2.9	0.2
Neutral detergent fibre (%)	8.5	1.5	Oleic acid C18:1	35.2	1.8
Acid detergent fibre (%)	6.1	1.0	Linoleic acid C18:2	16.4	0.9
Acid detergent lignin (%)	2.1	0.7	Linolenic acid C18:3	7.6	0.4
Water insoluble cell walls (%)	9.4	1.5			
Starch (%)	67.0	2.7	Fatty acids/ether extract (%)	80	
Total sugars (%)	2.0	0.6			
Gross energy (MJ/kg)	14.5	0.3			

Mineral elements	mean	sd	Vitamins	mean
Calcium (g/kg)	2.3	0.7	Vitamin B1 - thiamin (mg/kg)	1.7
Phosphorus (g/kg)	0.9	0.3	Vitamin B2 - riboflavin (mg/kg)	0.83
Phytate P / total P (%)	25		Vitamin B6 - pyridoxine (mg/kg)	1.0
Magnesium (g/kg)	1.1		Vitamin B12 (µg/kg)	0
Potassium (g/kg)	7.8	0.7	Niacin (mg/kg)	3
Sodium (g/kg)	0.3	0.4	Pantothenic acid (mg/kg)	1.0
Chlorine (g/kg)	0.2	0.1		
Sulphur (mg/kg)	2.7			
DCAD (mEq/kg)	38			
EB (mEq/kg)	208			
Manganese (mg/kg)	26			
Zinc (mg/kg)	15			
Copper (mg/kg)	4			
Iron (mg/kg)	15			
Selenium (mg/kg)	0.07			
Cobalt (mg/kg)	0.04			
Molybdenum (mg/kg)	0.05			

Pigs	Growing	Sow	Poultry	Cockerel	Broiler
DE (MJ/kg)	12.6	12.8	AMEn (MJ/kg)	12.6	12.6
ME (MJ/kg)	12.3	12.6	P availability (%)	25	
NE (MJ/kg)	10.0	10.1			
Ed (%)	87	88	Horses		
OMd (%)	89	91	UFC (per kg)	1.08	
Nd (%)	30	44	MADC (g/kg)	18	
EEd (%)		0			
Pd (%)		10	Rabbits		
			DE (MJ/kg)	12.8	
Ruminants			MEEn (MJ/kg)	12.6	
UFL (per kg)		0.91	Ed (%)	88	
UFV (per kg)		0.90	Nd (%)	50	
PDIA (g/kg)		11			
PDIN (g/kg)		19	Fish		
PDIE (g/kg)		63	DE (MJ/kg)		
ME (kcal/kg)		10.1	Ed (%)		
Ed (%)		82	Nd (%)		
OMd (%)		87			
Nd (%)		36			
TId (%)		85			
FAd (%)		44			
Absorbed phosphorus (g/kg)		0.5			
Ruminal degradation	Nitrogen	Starch	DM		
Effective degradability	59	84	89		
a (%)			76		
b (%)			23		
c (%/h)			8.0		

Amino acid content and digestibility

Amino acids	Total		Pigs				Poultry		Ruminants
	g/kg	% CP	AID %	AIDC g/kg	SID %	SIDC g/kg	TD %	TDC g/kg	AADI % PDIE
LYS	1.1	3.9							7.4
THR	0.8	3.0							5.3
MET	0.5	1.7							2.1
CYS	0.5	1.8							
MET+CYS	0.9	3.5							
TRP	0.2	0.8							
ILE	0.8	3.0							5.4
VAL	1.6	5.9							6.1
LEU	1.5	5.3							8.1
PHE	1.0	3.5							5.1
TYR	0.7	2.6							
PHE+TYR	1.7	6.1							
HIS	1.2	4.4							2.3
ARG	1.2	4.2							4.7
ALA	1.3	4.7							
ASP	1.9	6.9							
GLU	3.3	12.3							
GLY	0.9	3.3							
SER	0.9	3.4							
PRO	1.3	4.7							

Cassava, starch 72%

Dried cassava root (*Manihot esculenta* Crantz), containing 70-74% starch (as fed) (n = 2363).
All values are expressed on an as fed basis unless otherwise noted.

Main constituents	mean	sd	Fatty acids	%FA	g/kg
Dry matter (%)	87.3	1.1	Sum C6 + C8 + C10	0.6	0.0
Crude protein (%)	2.5	0.6	Lauric acid C12:0	3.9	0.2
Crude fibre (%)	2.9	0.7	Myristic acid C14:0	1.7	0.1
Ether extract (%)	0.5	0.3	Palmitic acid C16:0	31.9	1.4
Ash (%)	2.3	0.6	Palmitoleic acid C16:1	0.7	0.0
Insoluble ash (%)	0.3	0.6	Stearic acid C18:0	2.9	0.1
Neutral detergent fibre (%)	6.3	2.1	Oleic acid C18:1	35.2	1.5
Acid detergent fibre (%)	4.1	1.6	Linoleic acid C18:2	16.4	0.7
Acid detergent lignin (%)	1.2	0.6	Linolenic acid C18:3	7.6	0.3
Water insoluble cell walls (%)	11.1				
Starch (%)	71.6	2.4	Fatty acids/ether extract (%)	80	
Total sugars (%)	2.4	1.4			
Gross energy (MJ/kg)	14.9	0.3			

Mineral elements	mean	sd	Vitamins	mean
Calcium (g/kg)	1.5	0.8	Vitamin B1 - thiamin (mg/kg)	1.6
Phosphorus (g/kg)	0.8	0.3	Vitamin B2 - riboflavin (mg/kg)	0.82
Phytate P / total P (%)	25		Vitamin B6 - pyridoxine (mg/kg)	1.0
Magnesium (g/kg)	1.4		Vitamin B12 (µg/kg)	0
Potassium (g/kg)	5.7		Niacin (mg/kg)	3
Sodium (g/kg)	0.4		Pantothenic acid (mg/kg)	1.0
Chlorine (g/kg)	0.2	0.1		
Sulphur (mg/kg)	2.7			
DCAD (mEq/kg)	-6			
EB (mEq/kg)	161			
Manganese (mg/kg)	16			
Zinc (mg/kg)	19			
Copper (mg/kg)	4			
Iron (mg/kg)	17			
Selenium (mg/kg)	0.06			

Pigs	Growing	Sow	Poultry	Cockerel	Broiler
DE (MJ/kg)	13.8	14.0	AMEn (MJ/kg)	13.4	13.4
ME (MJ/kg)	13.6	13.7	P availability (%)	25	
NE (MJ/kg)	11.0	11.0	Horses		
Ed (%)	93	94	UFC (per kg)	1.12	
OMd (%)	93	94	MADC (g/kg)	17	
Nd (%)	30	40	Rabbits		
EEd (%)		0	DE (MJ/kg)	13.2	
Pd (%)		10	MEEn (MJ/kg)	13.1	
Ruminants			Ed (%)	89	
UFL (per kg)		0.99	Nd (%)	50	
UFV (per kg)		1.00	Fish		
PDIA (g/kg)		10	DE (MJ/kg)		
PDIN (g/kg)		18	Ed (%)		
PDIE (g/kg)		65	Nd (%)		
ME (kcal/kg)		10.9			
Ed (%)		86			
OMd (%)		90			
Nd (%)		37			
TId (%)		85			
FAd (%)		37			
Absorbed phosphorus (g/kg)		0.4			
<i>Ruminal degradation</i>	<i>Nitrogen</i>	<i>Starch</i>	<i>DM</i>		
Effective degradability	59	84	89		
a (%)	47	73	76		
b (%)	28	27	23		
c (%/h)	4.5	4.0	8.0		

Amino acid content and digestibility

Amino acids	Total		Pigs				Poultry		Ruminants
	g/kg	% CP	AID %	AIDC g/kg	SID %	SIDC g/kg	TD %	TDC g/kg	AADI % PDIE
LYS	1.0	3.9							7.4
THR	0.8	3.0							5.3
MET	0.4	1.7							2.1
CYS	0.5	1.8							
MET+CYS	0.9	3.5							
TRP	0.2	0.8							
ILE	0.8	3.0							5.4
VAL	1.5	5.8							6.1
LEU	1.3	5.3							8.1
PHE	0.9	3.5							5.1
TYR	0.6	2.6							
PHE+TYR	1.5	6.0							
HIS	1.1	4.3							2.3
ARG	1.1	4.3							4.7
ALA	1.2	4.7							
ASP	1.7	6.9							
GLU	3.1	12.4							
GLY	0.8	3.3							
SER	0.8	3.4							
PRO	1.2	4.6							

Maize starch

Maize starch (n = 10).

All values are expressed on an as fed basis unless otherwise noted.

Main constituents	mean	sd	Fatty acids	%FA	g/kg
Dry matter (%)	88.1	1.4	Myristic acid C14:0	0.1	0.0
Crude protein (%)	0.8	0.5	Palmitic acid C16:0	11.1	0.4
Crude fibre (%)	0.2	0.1	Palmitoleic acid C16:1	0.4	0.0
Ether extract (%)	0.4	0.3	Stearic acid C18:0	1.8	0.1
Ash (%)	0.2	0.2	Oleic acid C18:1	26.9	1.0
Neutral detergent fibre (%)	0.0		Linoleic acid C18:2	56.5	2.0
Starch (%)	83.7	4.8	Linolenic acid C18:3	1.0	0.0
Total sugars (%)	0.0				
Gross energy (MJ/kg)	15.4	0.3	Fatty acids/ether extract (%)	85	

Mineral elements	mean	sd
Calcium (g/kg)	0.2	

Pigs	Growing	Sow	Poultry	Cockerel	Broiler
DE (MJ/kg)	15.1	15.1	AMEn (MJ/kg)	14.8	
ME (MJ/kg)	14.9	14.9	P availability (%)		
NE (MJ/kg)	12.2	12.2	Horses		
Ed (%)	98	98	UFC (per kg)	1.31	
OMd (%)	98	98	MADC (g/kg)	7	
Nd (%)	0	0	Rabbits		
EEd (%)		0	DE (MJ/kg)	15.1	
Ruminants			ME (MJ/kg)	15.0	
UFL (per kg)		1.26	Ed (%)	98	
UFV (per kg)		1.33	Nd (%)	100	
PDIA (g/kg)		5	Fish		
PDIN (g/kg)		6	DE (MJ/kg)		
PDIE (g/kg)		69	Ed (%)		
ME (kcal/kg)		13.3	Nd (%)		
Ed (%)		100			
OMd (%)		100			
Nd (%)		0			
TId (%)		95			
Ruminal degradation	Nitrogen	Starch	DM		
Effective degradability	45	60	82		
a (%)					
b (%)					
c (%/h)					

Potato tuber, dried

Dried whole potato tuber (*Solanum tuberosum* L.), often a by-product from different potato processing industries (n = 49).

All values are expressed on an as fed basis unless otherwise noted.

Main constituents	mean	sd	Fatty acids	%FA	g/kg
Dry matter (%)	89.3	1.9	Myristic acid C14:0	0.4	0.0
Crude protein (%)	8.8	1.3	Palmitic acid C16:0	17.2	0.4
Crude fibre (%)	2.3	0.3	Palmitoleic acid C16:1	0.5	0.0
Ether extract (%)	0.3	0.3	Stearic acid C18:0	3.9	0.1
Ash (%)	5.0	1.0	Oleic acid C18:1	1.6	0.0
Insoluble ash (%)	0.8	1.1	Linoleic acid C18:2	29.2	0.8
Neutral detergent fibre (%)	7.9	3.8	Linolenic acid C18:3	20.7	0.5
Acid detergent fibre (%)	3.4	0.5	Arachidic acid C20:0	1.0	0.0
Acid detergent lignin (%)	0.8	0.4	Behenic acid C22:0	0.6	0.0
Starch (%)	65.5	3.5			
Total sugars (%)	1.9	0.8	Fatty acids/ether extract (%)	80	
Gross energy (MJ/kg)	15.2				

Mineral elements	mean	sd	Vitamins	mean
Calcium (g/kg)	1.1	0.4	Vitamin B1 - thiamin (mg/kg)	1.0
Phosphorus (g/kg)	2.1	0.4	Vitamin B2 - riboflavin (mg/kg)	0.60
Phytate P / total P (%)	25		Vitamin B6 - pyridoxine (mg/kg)	3
Magnesium (g/kg)	0.8		Vitamin B12 (µg/kg)	0
Potassium (g/kg)	19.5		Niacin (mg/kg)	10
Sodium (g/kg)	0.4		Pantothenic acid (mg/kg)	2
Chlorine (g/kg)	1.8		Folic acid (mg/kg)	0.80
Sulphur (mg/kg)	0.9		Biotin (mg/kg)	0.10
DCAD (mEq/kg)	408		Choline (%)	828
EB (mEq/kg)	466			
Manganese (mg/kg)	19			
Zinc (mg/kg)	25			
Copper (mg/kg)	4			
Iron (mg/kg)	58			
Selenium (mg/kg)	0.04			
Cobalt (mg/kg)	0.03			
Molybdenum (mg/kg)	1.2			
Iodine (mg/kg)	0.13			

Pigs	Growing	Sow	
DE (MJ/kg)	13.9	14.1	
ME (MJ/kg)	13.6	13.7	
NE (MJ/kg)	10.7	10.8	
Ed (%)	91	92	
OMd (%)	93	94	
Nd (%)	60	63	
EEd (%)		0	
Ruminants			
UFL (per kg)		0.96	
UFV (per kg)		0.96	
PDIA (g/kg)		21	
PDIN (g/kg)		58	
PDIE (g/kg)		74	
ME (kcal/kg)		10.8	
Ed (%)		84	
OMd (%)		88	
Nd (%)		67	
TId (%)		85	
FAd (%)		7	
<i>Ruminal degradation</i>	<i>Nitrogen</i>	<i>Starch</i>	<i>DM</i>
Effective degradability	75	79	70
a (%)	57	45	45
b (%)	30	55	52
c (%/h)	8.0	9.5	5.5

Amino acid content and digestibility

Amino acids	Total		Pigs				Poultry		Ruminants
	g/kg	% CP	AID %	AIDC g/kg	SID %	SIDC g/kg	TD %	TDC g/kg	AADI % PDIE
LYS	3.9	4.4							7.2
THR	3.1	3.5							5.2
MET	1.2	1.4							1.9
CYS	1.2	1.4							
MET+CYS	2.4	2.7							
TRP	0.7	0.8							
ILE	2.7	3.1							5.3
VAL	4.2	4.7							5.9
LEU	4.3	4.9							7.8
PHE	3.1	3.5							4.9
TYR	3.3	3.7							
PHE+TYR	6.4	7.2							
HIS	1.4	1.6							1.9
ARG	3.0	3.4							4.6
ALA	3.0	3.4							
ASP	14.3	16.1							
GLU	13.6	15.3							
GLY	2.6	2.9							
SER	3.0	3.4							
PRO	2.5	2.8							

Sweet potato, dried

Dried sweet potato tuber (*Ipomea batatas* (L.) Lam.) (n = 83).

All values are expressed on an as fed basis unless otherwise noted.

Main constituents	mean	sd	Fatty acids	%FA	g/kg
Dry matter (%)	87.8	1.5	Palmitic acid C16:0	28.0	1.7
Crude protein (%)	4.2	0.7	Stearic acid C18:0	2.9	0.2
Crude fibre (%)	2.6	0.4	Oleic acid C18:1	5.3	0.3
Ether extract (%)	0.8	0.5	Linoleic acid C18:2	53.6	3.2
Ash (%)	2.8	1.3	Linolenic acid C18:3	9.7	0.6
Insoluble ash (%)	0.2	0.2			
Neutral detergent fibre (%)	8.0	2.3	Fatty acids/ether extract (%)	70	
Acid detergent fibre (%)	4.2				
Acid detergent lignin (%)	0.8				
Starch (%)	64.5	2.9			
Total sugars (%)	6.7	1.9			
Gross energy (MJ/kg)	15.2	0.8			

Mineral elements	mean	sd
Calcium (g/kg)	1.2	1.7
Phosphorus (g/kg)	1.1	0.4
Phytate P / total P (%)	25	
Magnesium (g/kg)	0.8	
Potassium (g/kg)	3.6	
Sodium (g/kg)	1.6	
Chlorine (g/kg)	1.3	
Sulphur (mg/kg)	0.7	
DCAD (mEq/kg)	81	
EB (mEq/kg)	126	
Manganese (mg/kg)	11	
Zinc (mg/kg)	17	
Copper (mg/kg)	5	
Iron (mg/kg)	27	
Selenium (mg/kg)	0.02	
Iodine (mg/kg)	0.07	

Pigs	Growing	Sow	
DE (MJ/kg)	13.8	14.0	
ME (MJ/kg)	13.5	13.6	
NE (MJ/kg)	10.7	10.8	
Ed (%)	90	92	
OMd (%)	92	93	
Nd (%)	60	67	
EEd (%)		0	
Ruminants			
UFL (per kg)	0.97		
UFV (per kg)	0.97		
PDIA (g/kg)	12		
PDIN (g/kg)	28		
PDIE (g/kg)	66		
ME (kcal/kg)	10.8		
Ed (%)	84		
OMd (%)	88		
Nd (%)	51		
TId (%)	85		
FAd (%)	48		
<i>Ruminal degradation</i>	<i>Nitrogen</i>	<i>Starch</i>	<i>DM</i>
Effective degradability	70	79	75
a (%)			
b (%)			
c (%/h)			

Amino acid content and digestibility

Amino acids	Total		Pigs				Poultry		Ruminants
	g/kg	% CP	AID %	AIDC g/kg	SID %	SIDC g/kg	TD %	TDC g/kg	AADI % PDIE
LYS	1.9	4.6							7.3
THR	1.8	4.4							5.3
MET	0.7	1.6							2.0
CYS	0.7	1.8							
MET+CYS	1.4	3.4							
TRP	0.6	1.5							
ILE	1.9	4.7							5.5
VAL	2.8	6.8							6.0
LEU	2.5	6.0							8.0
PHE	2.3	5.5							5.2
TYR	1.8	4.3							
PHE+TYR	4.1	9.8							
HIS	0.8	1.9							1.9
ARG	1.8	4.4							4.6
ALA	2.3	5.5							
ASP	7.2	17.1							
GLU	4.1	9.8							
GLY	1.9	4.5							
SER	2.2	5.2							
PRO	1.8	4.4							

Alfalfa protein concentrate

Protein concentrate obtained by pressing the aerial part of alfalfa (*Medicago sativa* L.) (n = 69).
All values are expressed on an as fed basis unless otherwise noted.

Main constituents	mean	sd
Dry matter (%)	91.8	0.8
Crude protein (%)	50.2	2.4
Crude fibre (%)	2.6	1.0
Ether extract (%)	8.3	1.0
Ash (%)	11.2	1.8
Neutral detergent fibre (%)	7.3	
Acid detergent fibre (%)	3.8	
Water insoluble cell walls (%)	9.7	
Starch (%)	0.0	
Total sugars (%)	1.2	
Gross energy (MJ/kg)	19.8	

Mineral elements	mean	sd
Calcium (g/kg)	33.8	4.8
Phosphorus (g/kg)	8.0	0.9
Phytate P / total P (%)	5	
Magnesium (g/kg)	1.4	
Potassium (g/kg)	9.5	
Sodium (g/kg)	0.2	
Chlorine (g/kg)	1.8	
EB (mEq/kg)	201	

Vitamins	mean
Vitamin A (1000 UI/kg)	206
Vitamin E (mg/kg)	895
Vitamin K (mg/kg)	102
Vitamin B1 - thiamin (mg/kg)	3
Vitamin B2 - riboflavin (mg/kg)	5
Vitamin B6 - pyridoxine (mg/kg)	84
Vitamin B12 (µg/kg)	14
Niacin (mg/kg)	6
Pantothenic acid (mg/kg)	0
Folic acid (mg/kg)	0.73
Biotin (mg/kg)	0.20
Choline (%)	1069

Other	mean
Xanthophylls (mg/kg)	1297

Pigs	Growing	Sow	Poultry	Cockerel	Broiler
DE (MJ/kg)	16.5	16.8	AMEn (MJ/kg)	11.2	11.2
ME (MJ/kg)	15.1	15.3	P availability (%)	80	
NE (MJ/kg)	9.6	9.9	Horses		
Ed (%)	83	85	UFC (per kg)		
OMd (%)	86	88	MADC (g/kg)		
Nd (%)	85	86	Rabbits		
EEEd (%)		80	DE (MJ/kg)		
Ruminants			MEEn (MJ/kg)		
UFL (per kg)		1.16	Ed (%)		
UFV (per kg)		1.13	Nd (%)		
PDIA (g/kg)		397	Fish		
PDIN (g/kg)		446	DE (MJ/kg)		
PDIE (g/kg)		422	Ed (%)		
ME (kcal/kg)		13.1	Nd (%)		
Ed (%)		90			
OMd (%)		90			
Nd (%)		80			
TId (%)		95			
Absorbed phosphorus (g/kg)		5.9			
Ruminal degradation	Nitrogen	Starch	DM		
Effective degradability	25	65			
a (%)					
b (%)					
c (%/h)					

Amino acid content and digestibility

Amino acids	Total		Pigs				Poultry		Ruminants
	g/kg	% CP	AID %	AIDC g/kg	SID %	SIDC g/kg	TD %	TDC g/kg	AADI % PDIE
LYS	29.6	5.9							6.8
THR	21.8	4.3							4.9
MET	10.2	2.0							1.9
CYS	5.1	1.0							
MET+CYS	15.3	3.1							
TRP	11.8	2.4							
ILE	24.9	5.0							5.4
VAL	29.0	5.8							6.1
LEU	43.4	8.6							9.5
PHE	29.0	5.8							6.2
TYR	20.3	4.0							
PHE+TYR	49.3	9.8							
HIS	12.8	2.5							2.5
ARG	27.5	5.5							5.1
ALA	29.5	5.9							
ASP	46.3	9.2							
GLU	50.0	10.0							
GLY	25.5	5.1							
SER	19.0	3.8							
PRO	20.5	4.1							

Beet pulp, dried

Dried by-product from the manufacture of sugar, consisting of extracted beet roots (*Beta vulgaris* L.) (n = 2234).

All values are expressed on an as fed basis unless otherwise noted.

Main constituents	mean	sd	Fatty acids	%FA	g/kg
Dry matter (%)	89.1	1.3	Palmitic acid C16:0	20.6	0.7
Crude protein (%)	8.1	0.7	Stearic acid C18:0	1.4	0.1
Crude fibre (%)	17.3	1.4	Oleic acid C18:1	9.7	0.3
Ether extract (%)	0.9	0.4	Linoleic acid C18:2	57.8	2.0
Ash (%)	6.8	1.3	Linolenic acid C18:3	10.5	0.4
Insoluble ash (%)	1.6	1.2			
Neutral detergent fibre (%)	40.5	4.9	Fatty acids/ether extract (%)	40	
Acid detergent fibre (%)	20.6	2.0			
Acid detergent lignin (%)	1.9	0.8			
Water insoluble cell walls (%)	58.6	4.4			
Starch (%)	0.0				
Total sugars (%)	6.6	2.2			
Gross energy (MJ/kg)	15.2	0.7			

Mineral elements	mean	sd	Vitamins	mean
Calcium (g/kg)	13.2	4.0	Vitamin A (1000 UI/kg)	0.09
Phosphorus (g/kg)	0.9	0.3	Vitamin D (1000 UI/kg)	0.53
Phytate P / total P (%)	10		Vitamin E (mg/kg)	13
Magnesium (g/kg)	1.8	0.6	Vitamin B1 - thiamin (mg/kg)	0.34
Potassium (g/kg)	4.3	2.7	Vitamin B2 - riboflavin (mg/kg)	0.84
Sodium (g/kg)	2.9	4.5	Vitamin B6 - pyridoxine (mg/kg)	2
Chlorine (g/kg)	1.2	1.0	Vitamin B12 (µg/kg)	0
Sulphur (mg/kg)	2.4	1.2	Niacin (mg/kg)	18
DCAD (mEq/kg)	60		Pantothenic acid (mg/kg)	1.1
EB (mEq/kg)	207		Choline (%)	796
Manganese (mg/kg)	70	17		
Zinc (mg/kg)	19	9		
Copper (mg/kg)	5	2		
Iron (mg/kg)	601	310		
Selenium (mg/kg)	0.11	0.06		
Cobalt (mg/kg)	0.19			
Molybdenum (mg/kg)	0.67			
Iodine (mg/kg)	2			

Pigs	Growing	Sow	Poultry	Cockerel	Broiler
DE (MJ/kg)	10.9	12.3	AMEn (MJ/kg)		
ME (MJ/kg)	10.3	11.2	P availability (%)		
NE (MJ/kg)	6.2	7.1	Horses		
Ed (%)	72	81	UFC (per kg)	0.76	
OMd (%)	76	84	MADC (g/kg)	37	
Nd (%)	50	75	Rabbits		
NSId (%)		53	DE (MJ/kg)	10.3	
EEd (%)		0	MEEn (MJ/kg)	10.0	
Ruminants			Ed (%)	68	
UFL (per kg)		0.89	Nd (%)	50	
UFV (per kg)		0.87	Fish		
PDIA (g/kg)		37	DE (MJ/kg)		
PDIN (g/kg)		59	Ed (%)		
PDIE (g/kg)		97	Nd (%)		
ME (kcal/kg)		10.0			
Ed (%)		81			
OMd (%)		84			
Nd (%)		71			
TId (%)		85			
FAd (%)		26			
Absorbed phosphorus (g/kg)		0.8			
<i>Ruminal degradation</i>	<i>Nitrogen</i>	<i>Starch</i>	<i>DM</i>		
Effective degradability	52		59		
a (%)	3		4		
b (%)	89		90		
c (%/h)	7.5		9.5		

Amino acid content and digestibility

Amino acids	Total		Pigs				Poultry		Ruminants
	g/kg	% CP	AID	AIDC	SID	SIDC	TD	TDC	AADI
			%	g/kg	%	g/kg	%	g/kg	% PDIE
LYS	6.4	7.9	44	2.8	50	3.2			7.9
THR	4.0	4.9	22	0.9	31	1.2			5.3
MET	1.5	1.9	57	0.9	61	0.9			2.0
CYS	1.1	1.3	10	0.1	22	0.2			
MET+CYS	2.6	3.2	36	0.9	43	1.1			
TRP	0.8	1.0	31	0.3	41	0.3			
ILE	3.6	4.4	54	1.9	59	2.1			5.3
VAL	5.5	6.8	36	2.0	42	2.3			6.2
LEU	5.7	7.0	52	3.0	59	3.4			8.1
PHE	3.7	4.5	45	1.7	52	1.9			5.0
TYR	4.7	5.7	48	2.2	53	2.5			
PHE+TYR	8.4	10.3	47	3.9	52	4.4			
HIS	3.0	3.7	57	1.7	61	1.9			2.4
ARG	4.0	4.9	50	2.0	58	2.3			4.7
ALA	4.3	5.3	40	1.7	48	2.0			
ASP	6.5	8.0	53	3.4	59	3.8			
GLU	8.3	10.2	81	6.7	84	6.9			
GLY	3.8	4.7	12	0.5	25	0.9			
SER	4.6	5.7	31	1.4	38	1.7			
PRO	3.9	4.7							

Beet pulp, dried, molasses added

Dried by-product from the manufacture of sugar, consisting of extracted beet roots (*Beta vulgaris* L.), to which molasses have been added (n = 101).

All values are expressed on an as fed basis unless otherwise noted.

Main constituents	mean	sd	Fatty acids	%FA	g/kg
Dry matter (%)	88.3	2.1	Palmitic acid C16:0	20.6	0.5
Crude protein (%)	8.8	0.9	Stearic acid C18:0	1.4	0.0
Crude fibre (%)	17.1	2.2	Oleic acid C18:1	9.7	0.2
Ether extract (%)	0.6	0.4	Linoleic acid C18:2	57.8	1.3
Ash (%)	6.3	1.6	Linolenic acid C18:3	10.5	0.2
Insoluble ash (%)	1.4	0.9			
Neutral detergent fibre (%)	40.1	3.9	Fatty acids/ether extract (%)	40	
Acid detergent fibre (%)	20.4	0.8			
Acid detergent lignin (%)	1.0				
Water insoluble cell walls (%)	58.0				
Starch (%)	0.0				
Total sugars (%)	8.9	2.7			
Gross energy (MJ/kg)	15.1	0.8			

Mineral elements	mean	sd
Calcium (g/kg)	12.7	3.5
Phosphorus (g/kg)	0.9	0.1
Phytate P / total P (%)	10	
Magnesium (g/kg)	1.1	0.2
Potassium (g/kg)	4.3	
Sodium (g/kg)	2.9	1.8
Chlorine (g/kg)	1.1	
Sulphur (mg/kg)	2.3	1.2
DCAD (mEq/kg)	60	
EB (mEq/kg)	204	
Manganese (mg/kg)	73	
Zinc (mg/kg)	13	
Copper (mg/kg)	4	
Iron (mg/kg)	683	
Selenium (mg/kg)	0.11	
Cobalt (mg/kg)	0.19	
Molybdenum (mg/kg)	0.29	

Pigs	Growing	Sow	Poultry	Cockerel	Broiler
DE (MJ/kg)	11.0	12.3	AMEn (MJ/kg)		
ME (MJ/kg)	10.4	11.3	P availability (%)		
NE (MJ/kg)	6.3	7.2	Horses		
Ed (%)	73	82	UFC (per kg)	0.76	
OMd (%)	76	84	MADC (g/kg)	40	
Nd (%)	52	74	Rabbits		
EEd (%)		0	DE (MJ/kg)		
Ruminants			MEEn (MJ/kg)		
UFL (per kg)		0.88	Ed (%)		
UFV (per kg)		0.87	Nd (%)		
PDIA (g/kg)		22	Fish		
PDIN (g/kg)		57	DE (MJ/kg)		
PDIE (g/kg)		83	Ed (%)		
ME (kcal/kg)		10.0	Nd (%)		
Ed (%)		81			
OMd (%)		84			
Nd (%)		71			
TId (%)		85			
FAd (%)		0			
Absorbed phosphorus (g/kg)		0.8			
<i>Ruminal degradation</i>	<i>Nitrogen</i>	<i>Starch</i>	<i>DM</i>		
Effective degradability	74	64			
a (%)	26				
b (%)	65				
c (%/h)	17.5				

Amino acid content and digestibility

Amino acids	Total		Pigs				Poultry		Ruminants
	g/kg	% CP	AID %	AIDC g/kg	SID %	SIDC g/kg	TD %	TDC g/kg	AADI % PDIE
LYS	7.2	8.2							7.9
THR	4.2	4.8							5.3
MET	1.6	1.9							2.0
CYS	1.1	1.3							
MET+CYS	2.8	3.2							
TRP	0.9	1.0							
ILE	3.8	4.3							5.4
VAL	5.8	6.6							6.1
LEU	6.1	7.0							8.1
PHE	4.0	4.5							5.0
TYR	5.1	5.8							
PHE+TYR	9.1	10.3							
HIS	3.1	3.6							2.2
ARG	4.4	5.0							4.7
ALA	4.6	5.2							
ASP	7.0	8.0							
GLU	8.9	10.1							
GLY	4.0	4.6							
SER	5.0	5.7							
PRO	4.1	4.6							

Beet pulp, pressed

Moist by-product from the manufacture of sugar, consisting of extracted beet roots (*Beta vulgaris* L.), further pressed to reduce water content (n = 585).

All values are expressed on an as fed basis unless otherwise noted.

Main constituents	mean	sd	Fatty acids	%FA	g/kg
Dry matter (%)	24.1	2.6	Palmitic acid C16:0	20.6	0.1
Crude protein (%)	2.1	0.3	Stearic acid C18:0	1.4	0.0
Crude fibre (%)	5.0	0.6	Oleic acid C18:1	9.7	0.0
Ether extract (%)	0.1	0.1	Linoleic acid C18:2	57.8	0.3
Ash (%)	1.6	0.4	Linolenic acid C18:3	10.5	0.1
Insoluble ash (%)	0.3	0.3			
Neutral detergent fibre (%)	11.6	1.5	Fatty acids/ether extract (%)	40	
Acid detergent fibre (%)	5.8	0.7			
Acid detergent lignin (%)	0.4	0.1			
Water insoluble cell walls (%)	16.7	2.0			
Starch (%)	0.0				
Total sugars (%)	1.2	0.5			
Gross energy (MJ/kg)	4.1				

Mineral elements	mean	sd
Calcium (g/kg)	3.4	0.7
Phosphorus (g/kg)	0.2	0.1
Phytate P / total P (%)	10	
Magnesium (g/kg)	0.4	0.1
Potassium (g/kg)	1.0	0.2
Sodium (g/kg)	0.8	
Chlorine (g/kg)	0.3	
Sulphur (mg/kg)	0.5	0.2
DCAD (mEq/kg)	24	
EB (mEq/kg)	52	
Manganese (mg/kg)	17	3
Zinc (mg/kg)	4	1.0
Copper (mg/kg)	1.0	0
Iron (mg/kg)	116	42
Selenium (mg/kg)	0.03	

Pigs	Growing	Sow	
DE (MJ/kg)	3.0	3.3	
ME (MJ/kg)	2.8	3.1	
NE (MJ/kg)	1.7	1.9	
Ed (%)	72	81	
OMd (%)	76	84	
Nd (%)	50	76	
EEd (%)		0	
Ruminants			
UFL (per kg)		0.24	
UFV (per kg)		0.23	
PDIA (g/kg)		8	
PDIN (g/kg)		15	
PDIE (g/kg)		24	
ME (kcal/kg)		2.7	
Ed (%)		80	
OMd (%)		83	
Nd (%)		69	
TId (%)		85	
FAd (%)		0	
Absorbed phosphorus (g/kg)		0.2	
<i>Ruminal degradation</i>	<i>Nitrogen</i>	<i>Starch</i>	<i>DM</i>
Effective degradability	60		60
a (%)			
b (%)			
c (%/h)			

Amino acid content and digestibility

Amino acids	Total		Pigs				Poultry		Ruminants
	g/kg	% CP	AID %	AIDC g/kg	SID %	SIDC g/kg	TD %	TDC g/kg	AADI % PDIE
LYS	1.6	7.7							7.8
THR	1.0	5.0							5.3
MET	0.4	1.9							2.0
CYS	0.3	1.3							
MET+CYS	0.7	3.2							
TRP	0.2	1.0							
ILE	0.9	4.4							5.4
VAL	1.5	6.9							6.2
LEU	1.5	7.1							8.1
PHE	1.0	4.5							5.0
TYR	1.2	5.7							
PHE+TYR	2.1	10.2							
HIS	0.8	3.8							2.4
ARG	1.0	4.8							4.7
ALA	1.1	5.3							
ASP	1.7	8.0							
GLU	2.1	10.2							
GLY	1.0	4.7							
SER	1.2	5.7							
PRO	1.0	4.8							

Brewers' yeast, dried

Dried yeast (*Saccharomyces cerevisiae*), obtained in the main fermentation vats of malt wort after removal of the fermented liquid (n = 57).

All values are expressed on an as fed basis unless otherwise noted.

Main constituents	mean	sd
Dry matter (%)	93.3	2.5
Crude protein (%)	46.5	4.3
Crude fibre (%)	1.9	1.4
Ether extract (hydrolysis) (%)	3.9	1.1
Ash (%)	7.1	1.1
Neutral detergent fibre (%)	6.2	8.7
Acid detergent fibre (%)	1.8	2.4
Acid detergent lignin (%)	0.6	0.7
Starch (%)	1.0	
Total sugars (%)	0.3	
Gross energy (MJ/kg)	18.7	

Mineral elements	mean	sd	Vitamins	mean
Calcium (g/kg)	3.2	2.8	Vitamin E (mg/kg)	2
Phosphorus (g/kg)	11.6	1.6	Vitamin B1 - thiamin (mg/kg)	85
Phytate P / total P (%)	0		Vitamin B2 - riboflavin (mg/kg)	40
Magnesium (g/kg)	2.2		Vitamin B6 - pyridoxine (mg/kg)	34
Potassium (g/kg)	17.7		Vitamin B12 (µg/kg)	5
Sodium (g/kg)	1.7	1.1	Niacin (mg/kg)	448
Chlorine (g/kg)	2.9		Pantothenic acid (mg/kg)	111
Sulphur (mg/kg)	4.3		Folic acid (mg/kg)	10
DCAD (mEq/kg)	179		Biotin (mg/kg)	1.1
EB (mEq/kg)	445		Choline (%)	3335
Manganese (mg/kg)	40			
Zinc (mg/kg)	64			
Copper (mg/kg)	47			
Iron (mg/kg)	97			
Selenium (mg/kg)	0.82			
Cobalt (mg/kg)	0.20			
Molybdenum (mg/kg)	1.1			
Iodine (mg/kg)	0.02			

Pigs	Growing	Sow	Poultry	Cockerel	Broiler
DE (MJ/kg)	15.9	16.2	AMEn (MJ/kg)		
ME (MJ/kg)	14.5	14.6	P availability (%)		
NE (MJ/kg)	9.0	9.3			
Ed (%)	85	87	Horses		
OMd (%)	86	88	UFC (per kg)		
Nd (%)	85	86	MADC (g/kg)		
NSId (%)		69			
EEd (%)		80	Rabbits		
			DE (MJ/kg)		
Ruminants			MEEn (MJ/kg)		
UFL (per kg)		1.02	Ed (%)		
UFV (per kg)		0.98	Nd (%)		
PDIA (g/kg)		79			
PDIN (g/kg)		299	Fish		
PDIE (g/kg)		136	DE (MJ/kg)	13.4	
ME (kcal/kg)		11.7	Ed (%)	72	
Ed (%)		83	Nd (%)	82	
OMd (%)		85	Pd (%)		
Nd (%)		79			
TId (%)		95			
<i>Ruminal degradation</i>	<i>Nitrogen</i>	<i>Starch</i>	<i>DM</i>		
Effective degradability	84		81		
a (%)	64		60		
b (%)	29		34		
c (%/h)	14.0		9.5		

Amino acid content and digestibility

Amino acids	Total		Pigs				Poultry		Ruminants
	g/kg	% CP	AID	AIDC	SID	SIDC	TD	TDC	AADI
			%	g/kg	%	g/kg	%	g/kg	% PDIE
LYS	28.5	6.1	74	20.9	74	21.1			7.5
THR	20.1	4.3	65	13.1	66	13.3			5.3
MET	7.0	1.5	69	4.8	69	4.8			1.8
CYS	2.9	0.6	46	1.3	49	1.4			
MET+CYS	9.9	2.1	62	6.1	63	6.3			
TRP	4.9	1.0	53	2.6	55	2.7			
ILE	19.9	4.3	71	14.2	72	14.4			5.4
VAL	22.0	4.7	65	14.4	66	14.6			5.7
LEU	27.6	5.9	72	19.9	73	20.1			7.9
PHE	16.1	3.5	65	10.4	66	10.6			4.5
TYR	12.4	2.7	63	7.8	64	7.9			
PHE+TYR	28.5	6.1	64	18.3	65	18.6			
HIS	9.8	2.1	76	7.4	77	7.5			2.2
ARG	20.6	4.4	77	15.9	78	16.1			4.8
ALA	30.1	6.5	73	21.8	74	22.1			
ASP	36.9	7.9	74	27.3	75	27.7			
GLU	66.4	14.3	76	50.3	77	50.9			
GLY	17.9	3.8	64	11.5	67	12.0			
SER	19.4	4.2	68	13.1	69	13.3			
PRO	41.4	8.9							

Buckwheat hulls

Buckwheat hulls (*Fagopyrum esculentum* L.) (n = 71).

All values are expressed on an as fed basis unless otherwise noted.

Main constituents	mean	sd
Dry matter (%)	88.2	1.1
Crude protein (%)	6.9	2.4
Crude fibre (%)	38.7	5.4
Ether extract (%)	1.0	0.5
Ash (%)	2.8	0.9
Neutral detergent fibre (%)	78.9	
Acid detergent fibre (%)	64.1	
Acid detergent lignin (%)	26.4	
Starch (%)	1.1	
Total sugars (%)	0.9	
Gross energy (MJ/kg)	16.9	

Mineral elements	mean	sd
Calcium (g/kg)	0.6	
Phosphorus (g/kg)	1.2	
Potassium (g/kg)	2.7	

Pigs	Growing	Sow	
DE (MJ/kg)	4.2	5.4	
ME (MJ/kg)	3.8	4.7	
NE (MJ/kg)	1.8	2.2	
Ed (%)	25	32	
OMd (%)	31	37	
Nd (%)	27	52	
EEd (%)		0	
Ruminants			
UFL (per kg)		0.45	
UFV (per kg)		0.35	
PDIA (g/kg)		12	
PDIN (g/kg)		34	
PDIE (g/kg)		44	
ME (kcal/kg)		5.9	
Ed (%)		43	
OMd (%)		45	
Nd (%)		44	
TId (%)		40	
<i>Ruminal degradation</i>	<i>Nitrogen</i>	<i>Starch</i>	<i>DM</i>
Effective degradability	60		20
a (%)			
b (%)			
c (%/h)			

Carob pod meal

Dried, ground carob pods (*Ceratonia siliqua* L), a by-product from the extraction of mannogalactan from carob seeds (n = 76).

All values are expressed on an as fed basis unless otherwise noted.

Main constituents	mean	sd
Dry matter (%)	84.5	3.8
Crude protein (%)	4.4	0.6
Crude fibre (%)	7.3	1.2
Ether extract (%)	0.4	0.2
Ash (%)	3.0	0.8
Insoluble ash (%)	0.0	
Neutral detergent fibre (%)	27.1	2.6
Acid detergent fibre (%)	23.3	5.2
Acid detergent lignin (%)	13.0	3.7
Water insoluble cell walls (%)	33.1	
Starch (%)	0.6	0.5
Total sugars (%)	39.8	4.6
Gross energy (MJ/kg)	14.7	

Mineral elements	mean	sd
Calcium (g/kg)	4.3	2.0
Phosphorus (g/kg)	0.9	0.8
Phytate P / total P (%)	80	
Magnesium (g/kg)	0.5	0.2
Potassium (g/kg)	8.9	
Sodium (g/kg)	0.2	0.1
Chlorine (g/kg)	1.4	
EB (mEq/kg)	197	
Manganese (mg/kg)	10	
Zinc (mg/kg)	7	
Copper (mg/kg)	3	
Iron (mg/kg)	34	

Pigs	Growing	Sow	Poultry	Cockerel	Broiler
DE (MJ/kg)	7.6	8.3	AMEn (MJ/kg)		
ME (MJ/kg)	7.3	8.0	P availability (%)		
NE (MJ/kg)	5.1	5.5	Horses		
Ed (%)	51	56	UFC (per kg)	0.64	
OMd (%)	56	60	MADC (g/kg)	13	
Nd (%)	70	93	Rabbits		
EEd (%)		0	DE (MJ/kg)	8.5	
Ruminants			MEEn (MJ/kg)	8.4	
UFL (per kg)		0.70	Ed (%)	58	
UFV (per kg)		0.65	Nd (%)	20	
PDIA (g/kg)		14	Fish		
PDIN (g/kg)		27	DE (MJ/kg)		
PDIE (g/kg)		65	Ed (%)		
ME (kcal/kg)		8.3	Nd (%)		
Ed (%)		67			
OMd (%)		70			
Nd (%)		38			
TId (%)		65			
Ruminal degradation	Nitrogen	Starch	DM		
Effective degradability	55	65			
a (%)					
b (%)					
c (%/h)					

Amino acid content and digestibility

Amino acids	Total		Pigs				Poultry		Ruminants
	g/kg	% CP	AID %	AIDC g/kg	SID %	SIDC g/kg	TD %	TDC g/kg	AADI % PDIE
LYS	1.5	3.5							7.2
THR	1.4	3.1							5.2
MET	0.9	2.0							2.1
CYS	0.5	1.2							
MET+CYS	1.4	3.2							
TRP	0.8	1.8							
ILE	1.5	3.5							5.4
VAL	3.1	7.1							6.4
LEU	2.6	6.0							8.2
PHE	1.5	3.3							4.9
TYR	1.2	2.8							
PHE+TYR	2.7	6.1							
HIS	1.0	2.2							2.0
ARG	1.2	2.8							4.5
ALA	2.1	4.8							
ASP	3.6	8.2							
GLU	2.8	6.4							
GLY	1.2	2.8							
SER	1.8	4.0							
PRO	6.1	13.9							

Citrus pulp, dried

Dried by-product from citrus fruit processing for juice production or canning. It consists principally of the pulp and can include the skin and pips (n = 1413).

All values are expressed on an as fed basis unless otherwise noted.

Main constituents	mean	sd	Fatty acids	%FA	g/kg
Dry matter (%)	89.3	1.3	Lauric acid C12:0	0.8	0.1
Crude protein (%)	6.3	0.6	Myristic acid C14:0	0.7	0.1
Crude fibre (%)	12.1	0.9	Palmitic acid C16:0	25.9	3.4
Ether extract (%)	2.2	0.7	Stearic acid C18:0	4.8	0.6
Ash (%)	6.3	0.6	Oleic acid C18:1	25.9	3.4
Insoluble ash (%)	0.3	0.1	Linoleic acid C18:2	35.9	4.7
Neutral detergent fibre (%)	19.3	2.4	Linolenic acid C18:3	6.4	0.8
Acid detergent fibre (%)	13.8	1.7			
Acid detergent lignin (%)	2.5	2.6	Fatty acids/ether extract (%)	60	
Water insoluble cell walls (%)	33.1				
Starch (%)	2.9	2.1			
Total sugars (%)	20.3	3.7			
Gross energy (MJ/kg)	15.7	0.4			

Mineral elements	mean	sd
Calcium (g/kg)	15.2	2.5
Phosphorus (g/kg)	0.9	0.2
Phytate P / total P (%)	40	
Magnesium (g/kg)	1.2	0.4
Potassium (g/kg)	8.3	1.7
Sodium (g/kg)	1.4	1.5
Chlorine (g/kg)	0.3	0.1
Sulphur (mg/kg)	1.1	0.9
DCAD (mEq/kg)	195	
EB (mEq/kg)	264	
Manganese (mg/kg)	7	3
Zinc (mg/kg)	12	13
Copper (mg/kg)	3	2
Iron (mg/kg)	71	28
Cobalt (mg/kg)	0.14	
Molybdenum (mg/kg)	0.19	
Iodine (mg/kg)	0.09	

Pigs			Growing	Sow	Poultry		Cockerel	Broiler
DE (MJ/kg)			11.6	12.9	AMEn (MJ/kg)			
ME (MJ/kg)			11.0	12.0	P availability (%)			
NE (MJ/kg)			7.2	8.0	Horses			
Ed (%)			74	82	UFC (per kg)			
OMd (%)			77	85	MADC (g/kg)			
Nd (%)			57	87	Rabbits			
EEd (%)				36	DE (MJ/kg)		11.2	
Ruminants					MEEn (MJ/kg)		11.0	
UFL (per kg)			0.98		Ed (%)		72	
UFV (per kg)			0.98		Nd (%)		60	
PDIA (g/kg)			22		Fish			
PDIN (g/kg)			45		DE (MJ/kg)			
PDIE (g/kg)			86		Ed (%)			
ME (kcal/kg)			11.0		Nd (%)			
Ed (%)			84					
OMd (%)			88					
Nd (%)			68					
TId (%)			92					
FAd (%)			65					
Absorbed phosphorus (g/kg)			0.8					
<i>Ruminal degradation</i>								
			<i>Nitrogen</i>	<i>Starch</i>	<i>DM</i>			
Effective degradability			66	71				
a (%)			35	34				
b (%)			59	61				
c (%/h)			6.5	9.5				

Amino acid content and digestibility

Amino acids	Total		Pigs				Poultry		Ruminants
	g/kg	% CP	AID %	AIDC g/kg	SID %	SIDC g/kg	TD %	TDC g/kg	AADI % PDIE
LYS	2.6	4.1							7.3
THR	2.0	3.1							5.2
MET	0.7	1.2							1.9
CYS	0.9	1.4							
MET+CYS	1.6	2.5							
TRP	0.5	0.8							
ILE	2.0	3.1							5.3
VAL	2.8	4.4							5.9
LEU	3.3	5.2							8.0
PHE	2.6	4.1							5.2
TYR	1.9	3.0							
PHE+TYR	4.5	7.1							
HIS	1.5	2.3							2.1
ARG	2.9	4.6							4.8
ALA	2.7	4.2							
ASP	6.6	10.4							
GLU	5.1	8.1							
GLY	2.6	4.1							
SER	2.4	3.8							
PRO	5.8	9.2							

Cocoa hulls

Cocoa bean hulls, a by-product from the dehulling step in the cocoa butter extraction process (n = 237).

All values are expressed on an as fed basis unless otherwise noted.

Main constituents	mean	sd	Fatty acids	%FA	g/kg
Dry matter (%)	88.3	2.7	Myristic acid C14:0	0.1	0.0
Crude protein (%)	16.1	1.0	Palmitic acid C16:0	25.5	9.7
Crude fibre (%)	18.1	1.6	Palmitoleic acid C16:1	0.2	0.1
Ether extract (%)	5.1	1.7	Stearic acid C18:0	33.8	12.9
Ash (%)	8.4	0.8	Oleic acid C18:1	33.3	12.7
Insoluble ash (%)	0.7		Linoleic acid C18:2	2.3	0.9
Neutral detergent fibre (%)	41.5	4.4	Linolenic acid C18:3	0.5	0.2
Acid detergent fibre (%)	31.5	3.4	Arachidic acid C20:0	1.0	0.4
Acid detergent lignin (%)	15.9	2.0			
Starch (%)	7.2		Fatty acids/ether extract (%)	75	
Total sugars (%)	0.4				
Gross energy (MJ/kg)	16.5				

Mineral elements	mean	sd
Calcium (g/kg)	3.4	0.8
Phosphorus (g/kg)	4.0	0.7
Magnesium (g/kg)	3.8	
Potassium (g/kg)	20.7	
Sodium (g/kg)	0.3	
Chlorine (g/kg)	0.3	
EB (mEq/kg)	534	
Iron (mg/kg)	491	

Pigs	Growing	Sow	Poultry	Cockerel	Broiler
DE (MJ/kg)	3.3	4.5	AMEn (MJ/kg)		
ME (MJ/kg)	3.1	4.1	P availability (%)		
NE (MJ/kg)	2.1	2.6	Horses		
Ed (%)	20	27	UFC (per kg)		
OMd (%)	24	31	MADC (g/kg)		
Nd (%)	0	11	Rabbits		
EEd (%)		53	DE (MJ/kg)	5.4	
Ruminants			MEEn (MJ/kg)	5.1	
UFL (per kg)		0.41	Ed (%)	32	
UFV (per kg)		0.31	Nd (%)	25	
PDIA (g/kg)		54	Fish		
PDIN (g/kg)		95	DE (MJ/kg)		
PDIE (g/kg)		73	Ed (%)		
ME (kcal/kg)		5.4	Nd (%)		
Ed (%)		41			
OMd (%)		43			
Nd (%)		60			
TId (%)		60			
FAd (%)		74			
Ruminal degradation	Nitrogen	Starch	DM		
Effective degradability	50		38		
a (%)			8		
b (%)			53		
c (%/h)			8.0		

Amino acid content and digestibility

Amino acids	Total		Pigs				Poultry		Ruminants
	g/kg	% CP	AID %	AIDC g/kg	SID %	SIDC g/kg	TD %	TDC g/kg	AADI % PDIE
LYS	6.9	4.3							6.6
THR	5.6	3.5							5.0
MET	1.5	0.9							1.4
CYS	1.8	1.1							
MET+CYS	3.2	2.0							
TRP	1.8	1.1							
ILE	5.6	3.5							5.1
VAL	6.1	3.8							5.4
LEU	10.0	6.2							8.5
PHE	6.8	4.2							5.4
TYR	4.4	2.7							
PHE+TYR	11.1	6.9							
HIS	2.6	1.6							2.1
ARG	8.1	5.0							5.2
ALA	6.5	4.0							
ASP	13.9	8.6							
GLU	24.2	15.0							
GLY	5.2	3.2							
SER	6.5	4.0							
PRO	5.2	3.2							

Grape marc, dried

Dried by-product from pressing grapes (*Vitis vinifera* L.), containing the skins, pips, peduncles and sometimes the lignified stalks (n = 82).

All values are expressed on an as fed basis unless otherwise noted.

Main constituents	mean	sd	Fatty acids	%FA	g/kg
Dry matter (%)	91.8	1.7	Myristic acid C14:0	0.0	0.0
Crude protein (%)	13.1	1.2	Palmitic acid C16:0	6.6	2.9
Crude fibre (%)	22.4	3.4	Palmitoleic acid C16:1	0.2	0.1
Ether extract (%)	5.9	1.0	Stearic acid C18:0	3.3	1.5
Ash (%)	8.4	2.3	Oleic acid C18:1	15.8	7.0
Neutral detergent fibre (%)	57.1	6.6	Linoleic acid C18:2	68.5	30.3
Acid detergent fibre (%)	48.1	6.3	Linolenic acid C18:3	0.3	0.1
Acid detergent lignin (%)	32.2	6.0			
Starch (%)	0.0		Fatty acids/ether extract (%)	75	
Total sugars (%)	2.3	2.5			
Gross energy (MJ/kg)	17.3				

Mineral elements	mean	sd	Vitamins	mean
Calcium (g/kg)	7.8	2.3	Vitamin E (mg/kg)	4
Phosphorus (g/kg)	2.8	1.0		
Magnesium (g/kg)	0.8			
Potassium (g/kg)	7.4			
Sodium (g/kg)	0.1			
Chlorine (g/kg)	1.6			
Sulphur (mg/kg)	1.4			
DCAD (mEq/kg)	64			
EB (mEq/kg)	151			
Manganese (mg/kg)	11			
Zinc (mg/kg)	25			
Copper (mg/kg)	75	29		
Iron (mg/kg)	244			
Cobalt (mg/kg)	0.39			

Ruminants				Poultry		Cockerel	Broiler
UFL (per kg)			0.28	AMEn (MJ/kg)			
UFV (per kg)			0.17	P availability (%)			
PDIA (g/kg)			16	Horses			
PDIN (g/kg)			29	UFC (per kg)			
PDIE (g/kg)			25	MADC (g/kg)			
ME (kcal/kg)			3.9	Rabbits			
Ed (%)			28	DE (MJ/kg)		5.1	
OMd (%)			30	MEEn (MJ/kg)		5.1	
Nd (%)			49	Ed (%)		30	
TId (%)			15	Nd (%)		0	
FAd (%)			75	Fish			
<i>Ruminal degradation</i>	<i>Nitrogen</i>	<i>Starch</i>	<i>DM</i>	DE (MJ/kg)			
Effective degradability	26		26	Ed (%)			
a (%)	0		10	Nd (%)			
b (%)	45		35				
c (%/h)	8.0		5.0				

Amino acid content and digestibility

Amino acids	Total		Pigs				Poultry		Ruminants
	g/kg	% CP	AID %	AIDC g/kg	SID %	SIDC g/kg	TD %	TDC g/kg	AADI % PDIE
LYS	5.4	4.1							6.4
THR	2.6	2.0							4.3
MET	2.2	1.7							1.9
CYS	2.7	2.1							
MET+CYS	5.0	3.8							
TRP	1.2	0.9							
ILE	5.4	4.1							5.3
VAL	6.7	5.1							6.0
LEU	8.0	6.1							8.2
PHE	5.1	3.9							4.9
TYR	3.1	2.4							
PHE+TYR	8.2	6.3							
HIS	2.7	2.1							2.2
ARG	8.6	6.6							5.6
ALA	3.7	2.8							
ASP	8.6	6.6							
GLU	22.2	17.0							
GLY	8.2	6.3							
SER	3.7	2.8							
PRO	5.1	3.9							

Grape seeds

Grape seeds (*Vitis vinifera* L.). Synonym: grape pips (n = 14).

All values are expressed on an as fed basis unless otherwise noted.

Main constituents	mean	sd	Fatty acids	%FA	g/kg
Dry matter (%)	92.4	2.4	Myristic acid C14:0	0.0	0.0
Crude protein (%)	8.9	1.2	Palmitic acid C16:0	6.8	7.6
Crude fibre (%)	39.1	7.4	Palmitoleic acid C16:1	0.2	0.2
Ether extract (%)	11.8	3.5	Stearic acid C18:0	3.3	3.7
Ash (%)	3.2	0.7	Oleic acid C18:1	15.8	17.7
Neutral detergent fibre (%)	69.4	3.9	Linoleic acid C18:2	68.5	76.7
Acid detergent fibre (%)	60.3	6.2	Linolenic acid C18:3	0.3	0.3
Acid detergent lignin (%)	44.8	8.6			
Starch (%)	0.0		Fatty acids/ether extract (%)	95	
Total sugars (%)	1.1				
Gross energy (MJ/kg)	20.0				

Mineral elements	mean	sd
Calcium (g/kg)	7.0	
Phosphorus (g/kg)	1.6	
Copper (mg/kg)	14	

	Pigs	Growing	Sow
DE (MJ/kg)		7.8	8.8
ME (MJ/kg)		7.4	8.1
NE (MJ/kg)		4.9	5.2
Ed (%)		39	44
OMd (%)		44	49
Nd (%)		30	46
EEd (%)			65
Ruminants			
UFL (per kg)		0.35	
UFV (per kg)		0.23	
PDIA (g/kg)		8	
PDIN (g/kg)		29	
PDIE (g/kg)		17	
ME (kcal/kg)		4.8	
Ed (%)		30	
OMd (%)		30	
Nd (%)		34	
TId (%)		15	
FAd (%)		78	
<i>Ruminal degradation</i>	<i>Nitrogen</i>	<i>Starch</i>	<i>DM</i>
Effective degradability	47		19
a (%)	7		0
b (%)	56		33
c (%/h)	15.5		8.0

Amino acid content and digestibility

Amino acids	Total		Pigs				Poultry		Ruminants
	g/kg	% CP	AID %	AIDC g/kg	SID %	SIDC g/kg	TD %	TDC g/kg	AADI % PDIE
LYS	3.6	4.1							6.8
THR	1.8	2.0							4.6
MET	1.5	1.7							2.0
CYS	1.9	2.1							
MET+CYS	3.4	3.8							
TRP	0.8	0.9							
ILE	3.6	4.1							5.4
VAL	4.5	5.1							6.0
LEU	5.4	6.1							8.2
PHE	3.5	3.9							5.0
TYR	2.1	2.4							
PHE+TYR	5.6	6.3							
HIS	1.9	2.1							2.1
ARG	5.9	6.6							5.3
ALA	2.5	2.8							
ASP	5.9	6.6							
GLU	15.1	17.0							
GLY	5.6	6.3							
SER	2.5	2.8							
PRO	3.5	3.9							

Liquid potato feed

Liquid by-product from potato processing, composed of peels and discarded pieces of potato (n = 15).

All values are expressed on an as fed basis unless otherwise noted.

Main constituents	mean	sd	Fatty acids	%FA	g/kg
Dry matter (%)	17.6	4.2	Myristic acid C14:0	0.4	0.0
Crude protein (%)	2.2	0.8	Palmitic acid C16:0	17.2	0.2
Crude fibre (%)	0.8	0.4	Palmitoleic acid C16:1	0.5	0.0
Ether extract (%)	0.2	0.3	Stearic acid C18:0	3.9	0.1
Ash (%)	1.2	0.7	Oleic acid C18:1	1.6	0.0
Insoluble ash (%)	0.4		Linoleic acid C18:2	29.2	0.4
Neutral detergent fibre (%)	2.0	1.4	Linolenic acid C18:3	20.7	0.3
Acid detergent fibre (%)	1.1		Arachidic acid C20:0	1.0	0.0
Acid detergent lignin (%)	0.3		Behenic acid C22:0	0.6	0.0
Starch (%)	8.3	2.4			
Total sugars (%)	0.4		Fatty acids/ether extract (%)	60	
Gross energy (MJ/kg)	3.0				

Mineral elements	mean	sd
Calcium (g/kg)	0.3	
Phosphorus (g/kg)	0.4	
Phytate P / total P (%)	15	
Magnesium (g/kg)	0.3	
Potassium (g/kg)	6.2	
Sodium (g/kg)	0.1	
Chlorine (g/kg)	0.4	
Sulphur (mg/kg)	0.0	
DCAD (mEq/kg)	146	
EB (mEq/kg)	148	
Manganese (mg/kg)	5	
Zinc (mg/kg)	7	
Copper (mg/kg)	2	
Iron (mg/kg)	168	

Pigs	Growing	Sow	
DE (MJ/kg)	2.6	2.7	
ME (MJ/kg)	2.6	2.6	
NE (MJ/kg)	1.8	1.9	
Ed (%)	89	92	
OMd (%)	90	92	
Nd (%)	74	78	
EEed (%)		0	
Ruminants			
UFL (per kg)		0.18	
UFV (per kg)		0.17	
PDIA (g/kg)		8	
PDIN (g/kg)		15	
PDIE (g/kg)		20	
ME (kcal/kg)		2.0	
Ed (%)		81	
OMd (%)		85	
Nd (%)		69	
TId (%)		85	
FAd (%)		52	
<i>Ruminal degradation</i>	<i>Nitrogen</i>	<i>Starch</i>	<i>DM</i>
Effective degradability	64	79	64
a (%)	6		6
b (%)	80		90
c (%/h)	16.5		11.0

Amino acid content and digestibility

Amino acids	Total		Pigs				Poultry		Ruminants
	g/kg	% CP	AID %	AIDC g/kg	SID %	SIDC g/kg	TD %	TDC g/kg	AADI % PDIE
LYS	1.2	5.2							7.2
THR	0.9	4.0							5.2
MET	0.4	1.6							1.9
CYS	0.3	1.3							
MET+CYS	0.7	2.9							
TRP	0.2	0.9							
ILE	0.8	3.7							5.3
VAL	1.2	5.2							5.9
LEU	1.4	6.1							8.0
PHE	0.9	4.2							5.0
TYR	0.9	4.1							
PHE+TYR	1.8	8.3							
HIS	0.4	1.7							2.0
ARG	0.9	3.8							4.6
ALA	0.8	3.8							
ASP	3.4	15.2							
GLU	3.2	14.2							
GLY	0.8	3.4							
SER	0.9	3.8							
PRO	0.7	3.4							

Molasses, beet

Syrupy by-product from the crystallisation of beet sugar (*Beta vulgaris* L.) (n = 325).

All values are expressed on an as fed basis unless otherwise noted.

Main constituents	mean	sd
Dry matter (%)	75.7	2.7
Crude protein (%)	11.0	2.0
Crude fibre (%)	0.0	
Ether extract (%)	0.2	
Ash (%)	9.8	1.8
Insoluble ash (%)	0.0	
Starch (%)	0.0	
Total sugars (%)	46.6	3.9
Gross energy (MJ/kg)	11.7	0.6

Mineral elements	mean	sd	Vitamins	mean
Calcium (g/kg)	1.0	1.0	Vitamin E (mg/kg)	4
Phosphorus (g/kg)	0.2	0.2	Pantothenic acid (mg/kg)	3
Phytate P / total P (%)	10			
Magnesium (g/kg)	0.5	0.8		
Potassium (g/kg)	39.2	9.3		
Sodium (g/kg)	6.8	5.4		
Chlorine (g/kg)	4.5	3.2		
Sulphur (mg/kg)	4.2			
DCAD (mEq/kg)	909			
EB (mEq/kg)	1174			
Manganese (mg/kg)	29			
Zinc (mg/kg)	17			
Copper (mg/kg)	13			
Iron (mg/kg)	117			
Cobalt (mg/kg)	0.55			
Molybdenum (mg/kg)	0.26			
Iodine (mg/kg)	1.1			

Pigs	Growing	Sow	Poultry	Cockerel	Broiler
DE (MJ/kg)	9.9	10.2	AMEn (MJ/kg)	9.0	
ME (MJ/kg)	9.6	9.9	P availability (%)		
NE (MJ/kg)	6.6	6.8			
Ed (%)	85	88	Horses		
OMd (%)	85	87	UFC (per kg)	0.89	
Nd (%)	50	54	MADC (g/kg)	93	
EEd (%)		0			
Ruminants			Rabbits		
UFL (per kg)		0.75	DE (MJ/kg)	10.8	
UFV (per kg)		0.75	MEEn (MJ/kg)	10.3	
PDIA (g/kg)		0	Ed (%)	92	
PDIN (g/kg)		63	Nd (%)	70	
PDIE (g/kg)		54			
ME (kcal/kg)		8.3	Fish		
Ed (%)		86	DE (MJ/kg)		
OMd (%)		89	Ed (%)		
Nd (%)		72	Nd (%)		
TId (%)		100			
Absorbed phosphorus (g/kg)		0.1			
Ruminal degradation	Nitrogen	Starch	DM		
Effective degradability	100	100			
a (%)					
b (%)					
c (%/h)					

Amino acid content and digestibility

Amino acids	Total		Pigs				Poultry		Ruminants
	g/kg	% CP	AID %	AIDC g/kg	SID %	SIDC g/kg	TD %	TDC g/kg	AADI % PDIE
LYS	1.6	1.5							7.7
THR	0.7	0.6							5.4
MET	0.2	0.2							2.1
CYS	0.7	0.6							
MET+CYS	0.9	0.9							
TRP	0.8	0.8							
ILE	2.8	2.6							5.6
VAL	1.9	1.8							5.9
LEU	2.9	2.6							8.1
PHE	0.5	0.5							5.1
TYR	2.9	2.7							
PHE+TYR	3.4	3.1							
HIS	0.6	0.5							1.9
ARG	0.8	0.8							4.6
ALA	1.9	1.8							
ASP	5.9	5.4							
GLU	52.5	47.9							
GLY	1.9	1.7							
SER	2.2	2.0							
PRO	1.0	0.9							

Molasses, sugarcane

Syrupy by-product from the crystallisation of cane sugar (*Saccharum officinarum* L.) (n = 1287).
All values are expressed on an as fed basis unless otherwise noted.

Main constituents	mean	sd	Fatty acids	%FA	g/kg
Dry matter (%)	73.7	1.5	Myristic acid C14:0	1.1	0.1
Crude protein (%)	4.0	1.1	Palmitic acid C16:0	26.8	3.0
Crude fibre (%)	0.0		Stearic acid C18:0	3.2	0.4
Ether extract (%)	1.1	0.5	Oleic acid C18:1	13.9	1.6
Ash (%)	10.3	2.1	Linoleic acid C18:2	43.4	4.9
Insoluble ash (%)	0.1				
Starch (%)	0.0				
Total sugars (%)	47.1	2.8			
Gross energy (MJ/kg)	11.0	0.5			

Mineral elements	mean	sd	Vitamins	mean
Calcium (g/kg)	7.4	1.5	Vitamin E (mg/kg)	5
Phosphorus (g/kg)	0.6	0.3	Vitamin B1 - thiamin (mg/kg)	0.71
Phytate P / total P (%)	10		Vitamin B2 - riboflavin (mg/kg)	2
Magnesium (g/kg)	3.3	0.9	Vitamin B6 - pyridoxine (mg/kg)	3
Potassium (g/kg)	37.4	10.9	Niacin (mg/kg)	28
Sodium (g/kg)	2.4	4.1	Pantothenic acid (mg/kg)	29
Chlorine (g/kg)	15.9	6.0	Folic acid (mg/kg)	0.08
Sulphur (mg/kg)	5.3	2.2	Biotin (mg/kg)	0.53
DCAD (mEq/kg)	283		Choline (%)	552
EB (mEq/kg)	615			
Manganese (mg/kg)	59	21		
Zinc (mg/kg)	13	15		
Copper (mg/kg)	29			
Iron (mg/kg)	188			
Cobalt (mg/kg)	0.90			
Molybdenum (mg/kg)	1.3			

Pigs	Growing	Sow	Poultry	Cockerel	Broiler
DE (MJ/kg)	9.4	9.7	AMEn (MJ/kg)	9.6	
ME (MJ/kg)	9.2	9.5	P availability (%)		
NE (MJ/kg)	6.4	6.7			
Ed (%)	85	88	Horses		
OMd (%)	85	87	UFC (per kg)	0.88	
Nd (%)	40	50	MADC (g/kg)	24	
EEd (%)		0			
Ruminants			Rabbits		
UFL (per kg)		0.63	DE (MJ/kg)	9.9	
UFV (per kg)		0.62	MEEn (MJ/kg)	9.8	
PDIA (g/kg)		0	Ed (%)	90	
PDIN (g/kg)		23	Nd (%)	60	
PDIE (g/kg)		46			
ME (kcal/kg)		7.2	Fish		
Ed (%)		77	DE (MJ/kg)		
OMd (%)		80	Ed (%)		
Nd (%)		42	Nd (%)		
TId (%)		100			
FAd (%)		65			
Absorbed phosphorus (g/kg)		0.4			
Ruminal degradation	Nitrogen	Starch	DM		
Effective degradability	100	100	100		
a (%)					
b (%)					
c (%/h)					

Amino acid content and digestibility

Amino acids	Total		Pigs				Poultry		Ruminants
	g/kg	% CP	AID %	AIDC g/kg	SID %	SIDC g/kg	TD %	TDC g/kg	AADI % PDIE
LYS	0.1	0.4							7.7
THR	0.6	1.4							5.4
MET	0.2	0.4							2.1
CYS	0.4	0.9							
MET+CYS	0.5	1.3							
TRP	0.1	0.2							
ILE	0.3	0.9							5.6
VAL	1.2	3.0							5.9
LEU	0.5	1.3							8.1
PHE	0.2	0.6							5.1
TYR	0.5	1.3							
PHE+TYR	0.8	1.9							
HIS	0.1	0.3							1.9
ARG	0.2	0.6							4.6
ALA	2.5	6.1							
ASP	9.0	22.2							
GLU	4.2	10.3							
GLY	0.7	1.7							
SER	0.8	1.9							
PRO	0.5	1.3							

Potato protein concentrate

Dried by-product from potato starch manufacture composed mainly of protein substances obtained after the separation of starch (n = 103).

All values are expressed on an as fed basis unless otherwise noted.

Main constituents	mean	sd	Fatty acids	%FA	g/kg
Dry matter (%)	92.3	1.6	Myristic acid C14:0	0.4	0.0
Crude protein (%)	77.6	3.0	Palmitic acid C16:0	17.2	1.3
Crude fibre (%)	0.8	1.0	Palmitoleic acid C16:1	0.5	0.0
Ether extract (%)	0.9	0.9	Stearic acid C18:0	3.9	0.3
Ash (%)	2.6	0.9	Oleic acid C18:1	1.6	0.1
Neutral detergent fibre (%)	6.0		Linoleic acid C18:2	29.2	2.2
Acid detergent fibre (%)	1.7		Linolenic acid C18:3	20.7	1.5
Acid detergent lignin (%)	0.4		Arachidic acid C20:0	1.0	0.1
Starch (%)	0.7	1.6	Behenic acid C22:0	0.6	0.0
Total sugars (%)	0.9				
Gross energy (MJ/kg)	20.5		Fatty acids/ether extract (%)	80	

Mineral elements	mean	sd
Calcium (g/kg)	2.9	2.8
Phosphorus (g/kg)	4.0	1.2
Phytate P / total P (%)	15	
Magnesium (g/kg)	0.5	
Potassium (g/kg)	5.5	0.9
Sodium (g/kg)	0.1	
Chlorine (g/kg)	2.9	
Sulphur (mg/kg)	3.6	
DCAD (mEq/kg)	-164	
EB (mEq/kg)	63	
Manganese (mg/kg)	5	
Zinc (mg/kg)	21	
Copper (mg/kg)	38	
Iron (mg/kg)	455	257
Selenium (mg/kg)	1.0	

Pigs	Growing	Sow	
DE (MJ/kg)	19.4	19.5	
ME (MJ/kg)	17.3	17.4	
NE (MJ/kg)	10.3	10.4	
Ed (%)	94	95	
OMd (%)	95	95	
Nd (%)	95	95	
NSId (%)		87	
EEd (%)		0	
Ruminants			
UFL (per kg)		1.19	
UFV (per kg)		1.16	
PDIA (g/kg)		462	
PDIN (g/kg)		626	
PDIE (g/kg)		495	
ME (kcal/kg)		13.5	
Ed (%)		95	
OMd (%)		91	
Nd (%)		81	
TId (%)		94	
FAd (%)		53	
Absorbed phosphorus (g/kg)		3.0	
<i>Ruminal degradation</i>	<i>Nitrogen</i>	<i>Starch</i>	<i>DM</i>
Effective degradability	43		35
a (%)	2		4
b (%)	94		94
c (%/h)	4.5		3.0

Amino acid content and digestibility

Amino acids	Total		Pigs				Poultry		Ruminants
	g/kg	% CP	AID	AIDC	SID	SIDC	TD	TDC	AADI
			%	g/kg	%	g/kg	%	g/kg	% PDIE
LYS	58.9	7.6	89	52.4	89	52.6			7.4
THR	43.1	5.6	89	38.3	90	38.6			5.3
MET	17.3	2.2	91	15.7	91	15.8			1.9
CYS	10.3	1.3	77	8.0	78	8.1			
MET+CYS	27.7	3.6	86	23.7	86	23.8			
TRP	9.5	1.2	73	7.0	75	7.2			
ILE	44.0	5.7	89	39.1	89	39.3			5.4
VAL	51.2	6.6	89	45.4	89	45.7			6.1
LEU	76.1	9.8	91	69.0	91	69.4			9.5
PHE	48.3	6.2	91	43.7	91	43.9			5.9
TYR	40.2	5.2	88	35.5	89	35.6			
PHE+TYR	88.5	11.4	90	79.2	90	79.6			
HIS	17.3	2.2	89	15.4	89	15.5			2.1
ARG	40.2	5.2	92	36.9	92	37.2			4.7
ALA	37.0	4.8	85	31.4	86	31.7			
ASP	97.0	12.5	89	86.6	90	87.2			
GLU	82.5	10.6	86	71.0	87	71.6			
GLY	36.6	4.7	83	30.3	84	30.7			
SER	39.7	5.1	88	35.1	89	35.4			
PRO	39.3	5.1	98	38.7	100	39.1			

Potato pulp, dried

Dried by-product from potato processing, and particularly of starch manufacture (n = 52).

All values are expressed on an as fed basis unless otherwise noted.

Main constituents	mean	sd	Fatty acids	%FA	g/kg
Dry matter (%)	87.4	1.9	Myristic acid C14:0	0.4	0.0
Crude protein (%)	4.6	1.1	Palmitic acid C16:0	17.2	0.4
Crude fibre (%)	15.9	1.9	Palmitoleic acid C16:1	0.5	0.0
Ether extract (%)	0.4	0.3	Stearic acid C18:0	3.9	0.1
Ash (%)	3.2	1.6	Oleic acid C18:1	1.6	0.0
Insoluble ash (%)	0.1		Linoleic acid C18:2	29.2	0.7
Neutral detergent fibre (%)	25.9	3.4	Linolenic acid C18:3	20.7	0.5
Acid detergent fibre (%)	18.0	2.8	Arachidic acid C20:0	1.0	0.0
Acid detergent lignin (%)	5.0	2.8	Behenic acid C22:0	0.6	0.0
Starch (%)	37.8	6.9			
Total sugars (%)	1.8		Fatty acids/ether extract (%)	60	
Gross energy (MJ/kg)	15.4				

Mineral elements	mean	sd
Calcium (g/kg)	5.4	3.3
Phosphorus (g/kg)	1.3	0.9
Phytate P / total P (%)	10	
Magnesium (g/kg)	1.4	
Potassium (g/kg)	7.5	
Sodium (g/kg)	1.3	
Chlorine (g/kg)	1.8	
Sulphur (mg/kg)	1.0	
DCAD (mEq/kg)	135	
EB (mEq/kg)	198	
Manganese (mg/kg)	43	
Zinc (mg/kg)	40	
Copper (mg/kg)	7	
Iron (mg/kg)	692	

Pigs	Growing	Sow	Poultry	Cockerel	Broiler
DE (MJ/kg)	11.0	11.9	AMEn (MJ/kg)		
ME (MJ/kg)	10.6	11.3	P availability (%)		
NE (MJ/kg)	7.7	8.2	Horses		
Ed (%)	72	77	UFC (per kg)	0.95	
OMd (%)	74	79	MADC (g/kg)	8	
Nd (%)	57	84	Rabbits		
EEd (%)		0	DE (MJ/kg)	10.6	
Ruminants			MEEn (MJ/kg)	10.3	
UFL (per kg)		0.65	Ed (%)	69	
UFV (per kg)		0.58	Nd (%)	74	
PDIA (g/kg)		13	Fish		
PDIN (g/kg)		30	DE (MJ/kg)		
PDIE (g/kg)		52	Ed (%)		
ME (kcal/kg)		7.8	Nd (%)		
Ed (%)		61			
OMd (%)		64			
Nd (%)		25			
TId (%)		75			
FAd (%)		0.76			
Ruminal degradation	Nitrogen	Starch	DM		
Effective degradability	65	79	65		
a (%)					
b (%)					
c (%/h)					

Amino acid content and digestibility

Amino acids	Total		Pigs				Poultry		Ruminants
	g/kg	% CP	AID %	AIDC g/kg	SID %	SIDC g/kg	TD %	TDC g/kg	AADI % PDIE
LYS	0.6	1.2							6.7
THR	0.7	1.4							5.0
MET	0.2	0.5							1.8
CYS	0.6	1.4							
MET+CYS	0.9	1.9							
TRP	0.2	0.4							
ILE	0.2	0.5							4.9
VAL	1.3	2.9							5.7
LEU	0.0	0.0							6.7
PHE	0.4	0.8							4.2
TYR	1.0	2.3							
PHE+TYR	1.4	3.1							
HIS	0.4	1.0							1.9
ARG	0.8	1.6							4.4
ALA	1.0	2.1							
ASP	9.1	19.8							
GLU	9.2	20.0							
GLY	0.5	1.2							
SER	0.8	1.7							
PRO	0.2	0.5							

Soybean hulls

Soybean hulls, a by-product from the dehulling step in soybean oil manufacturing (n = 349)

All values are expressed on an as fed basis unless otherwise noted.

Main constituents	mean	sd	Fatty acids	%FA	g/kg
Dry matter (%)	89.4	1.1	Myristic acid C14:0	0.1	0.0
Crude protein (%)	12.0	2.3	Palmitic acid C16:0	10.5	2.2
Crude fibre (%)	34.2	3.2	Palmitoleic acid C16:1	0.2	0.0
Ether extract (%)	2.2	1.2	Stearic acid C18:0	3.8	0.8
Ash (%)	4.7	0.4	Oleic acid C18:1	21.7	4.5
Insoluble ash (%)	0.2		Linoleic acid C18:2	53.1	11.1
Neutral detergent fibre (%)	56.4	4.8	Linolenic acid C18:3	7.4	1.6
Acid detergent fibre (%)	40.4	3.9			
Acid detergent lignin (%)	2.1	1.0	Fatty acids/ether extract (%)	95	
Water insoluble cell walls (%)	61.8	3.8			
Starch (%)	0.0				
Total sugars (%)	1.5				
Gross energy (MJ/kg)	16.3	0.3			

Mineral elements	mean	sd
Calcium (g/kg)	4.9	1.0
Phosphorus (g/kg)	1.4	0.5
Phytate P / total P (%)	60	
Magnesium (g/kg)	2.2	0.5
Potassium (g/kg)	12.0	3.1
Sodium (g/kg)	0.1	0.1
Chlorine (g/kg)	0.2	0.1
Sulphur (mg/kg)	1.1	
DCAD (mEq/kg)	239	
EB (mEq/kg)	305	
Manganese (mg/kg)	22	8
Zinc (mg/kg)	40	11
Copper (mg/kg)	8	3
Iron (mg/kg)	580	247
Selenium (mg/kg)	0.21	
Cobalt (mg/kg)	0.11	
Molybdenum (mg/kg)	1.2	

Pigs			Growing	Sow	Poultry		Cockerel	Broiler
DE (MJ/kg)			8.4	11.5	AMEn (MJ/kg)			
ME (MJ/kg)			7.8	10.4	P availability (%)			
NE (MJ/kg)			4.2	6.0	Horses			
Ed (%)			51	70	UFC (per kg)		0.62	
OMd (%)			55	72	MADC (g/kg)		60	
Nd (%)			41	78	Rabbits			
NSId (%)				57	DE (MJ/kg)		7.2	
EEd (%)				2	MEEn (MJ/kg)		6.8	
Ruminants					Ed (%)		44	
UFL (per kg)				0.90	Nd (%)		50	
UFV (per kg)				0.87	Fish			
PDIA (g/kg)				40	DE (MJ/kg)			
PDIN (g/kg)				75	Ed (%)			
PDIE (g/kg)				98	Nd (%)			
ME (kcal/kg)				10.4	Ruminants			
Ed (%)				80	UFL (per kg)			
OMd (%)				82	UFV (per kg)			
Nd (%)				78	PDIA (g/kg)			
TId (%)				67	PDIN (g/kg)			
FAd (%)				70	PDIE (g/kg)			
<i>Ruminal degradation</i>	<i>Nitrogen</i>	<i>Starch</i>	<i>DM</i>		ME (kcal/kg)			
Effective degradability	55		43		Ed (%)			
a (%)	19		6		OMd (%)			
b (%)	71		92		Nd (%)			
c (%/h)	6.0		4.0		TId (%)			

Amino acid content and digestibility

Amino acids	Total		Pigs				Poultry		Ruminants
	g/kg	% CP	AID	AIDC	SID	SIDC	TD	TDC	AADI
			%	g/kg	%	g/kg	%	g/kg	% PDIE
LYS	7.1	5.9	57	4.0	60	4.3			7.5
THR	4.3	3.6	55	2.4	61	2.6			5.1
MET	1.4	1.2	68	1.0	71	1.0			1.8
CYS	1.9	1.6	57	1.1	63	1.2			
MET+CYS	3.3	2.8	62	2.1	66	2.2			
TRP	1.4	1.2	57	0.8	63	0.9			
ILE	4.4	3.7	64	2.8	68	3.0			5.3
VAL	5.1	4.3	57	2.9	61	3.1			5.6
LEU	7.4	6.2	66	4.9	70	5.2			8.1
PHE	4.5	3.8	68	3.1	72	3.2			4.9
TYR	3.6	3.0	61	2.2	64	2.3			
PHE+TYR	8.1	6.7	65	5.2	69	5.5			
HIS	2.8	2.3	55	1.5	58	1.6			2.2
ARG	5.9	4.9	81	4.7	84	4.9			4.8
ALA	4.8	4.0	51	2.4	56	2.7			
ASP	10.5	8.8	65	6.8	69	7.2			
GLU	14.2	11.8	71	10.0	74	10.5			
GLY	8.0	6.6	32	2.6	38	3.0			
SER	6.4	5.3	55	3.6	59	3.8			
PRO	4.6	3.9							

Vinasse, different origins

Moist product obtained by mixing the fermentation by-products of different industries.

This product has been concentrated and demineralised (n = 229).

All values are expressed on an as fed basis unless otherwise noted.

Main constituents	mean	sd
Dry matter (%)	68.7	3.4
Crude protein (%)	44.1	3.4
Crude fibre (%)	0.0	
Ether extract (%)	0.7	
Ash (%)	4.7	1.1
Starch (%)	0.0	
Total sugars (%)	5.4	1.6
Gross energy (MJ/kg)	13.6	

Mineral elements	mean	sd	Vitamins	mean
Calcium (g/kg)	1.7	0.6	Vitamin B1 - thiamin (mg/kg)	79
Phosphorus (g/kg)	2.2	1.1	Vitamin B2 - riboflavin (mg/kg)	28
Phytate P / total P (%)	10		Niacin (mg/kg)	264
Magnesium (g/kg)	1.0			
Potassium (g/kg)	6.2	2.1		
Sodium (g/kg)	9.4	2.3		
Chlorine (g/kg)	15.4	5.0		
EB (mEq/kg)	132			
Iron (mg/kg)	277			
Selenium (mg/kg)	0			

Pigs	Growing	Sow	
DE (MJ/kg)	10.2	10.2	
ME (MJ/kg)	9.2	9.2	
NE (MJ/kg)	5.6	5.5	
Ed (%)	75	75	
OMd (%)	75	75	
Nd (%)	75	75	
EEd (%)		75	
Ruminants			
UFL (per kg)		0.62	
UFV (per kg)		0.57	
PDIA (g/kg)		0	
PDIN (g/kg)		254	
PDIE (g/kg)		44	
ME (kcal/kg)		7.4	
Ed (%)		75	
OMd (%)		75	
Nd (%)		78	
TId (%)		100	
Absorbed phosphorus (g/kg)		1.6	
Ruminal degradation	Nitrogen	Starch	DM
Effective degradability	100		100
a (%)			
b (%)			
c (%/h)			

Amino acid content and digestibility

Amino acids	Total		Pigs				Poultry		Ruminants
	g/kg	% CP	AID %	AIDC g/kg	SID %	SIDC g/kg	TD %	TDC g/kg	AADI % PDIE
LYS	5.7	1.3							7.7
THR	7.1	1.6							5.4
MET	0.0	0.0							2.1
CYS	3.0	0.7							
MET+CYS	3.0	0.7							
TRP	1.8	0.4							
ILE	1.1	0.3							5.6
VAL	2.9	0.7							5.9
LEU	1.0	0.2							8.1
PHE	0.0	0.0							5.1
TYR	0.0	0.0							
PHE+TYR	0.0	0.0							
HIS	0.0	0.0							1.9
ARG	0.0	0.0							4.6
ALA	25.2	5.7							
ASP	1.9	0.4							
GLU	9.6	2.2							
GLY	2.5	0.6							
SER	0.5	0.1							
PRO	2.5	0.6							

Vinasse, from the production of glutamic acid

Moist by-product from the production of glutamic acid obtained after fermentation of organic substances, particularly molasses. This product has been concentrated and demineralised (n = 174).

All values are expressed on an as fed basis unless otherwise noted.

Main constituents	mean	sd
Dry matter (%)	71.2	3.3
Crude protein (%)	49.3	3.7
Crude fibre (%)	0.0	
Ether extract (%)	0.6	
Ash (%)	4.2	0.5
Starch (%)	0.0	
Total sugars (%)	4.9	1.5
Gross energy (MJ/kg)	14.4	

Mineral elements	mean	sd
Calcium (g/kg)	0.3	
Phosphorus (g/kg)	3.0	
Phytate P / total P (%)	10	
Magnesium (g/kg)	0.6	
Potassium (g/kg)	2.6	0.7
Sodium (g/kg)	10.4	2.0
Chlorine (g/kg)	9.6	1.5
EB (mEq/kg)	249	
Selenium (mg/kg)	2	

Pigs	Growing	Sow	
DE (MJ/kg)	10.8	10.8	
ME (MJ/kg)	9.8	9.8	
NE (MJ/kg)	5.8	5.8	
Ed (%)	75	75	
OMd (%)	75	75	
Nd (%)	75	75	
EEd (%)		75	
Ruminants			
UFL (per kg)		0.65	
UFV (per kg)		0.60	
PDIA (g/kg)		0	
PDIN (g/kg)		284	
PDIE (g/kg)		46	
ME (kcal/kg)		7.7	
Ed (%)		75	
OMd (%)		75	
Nd (%)		78	
TId (%)		100	
Absorbed phosphorus (g/kg)		2.2	
Ruminal degradation	Nitrogen	Starch	DM
Effective degradability	100		100
a (%)			
b (%)			
c (%/h)			

Amino acid content and digestibility

Amino acids	Total		Pigs				Poultry		Ruminants
	g/kg	% CP	AID %	AIDC g/kg	SID %	SIDC g/kg	TD %	TDC g/kg	AADI % PDIE
LYS	1.0	0.2							7.7
THR	0.3	0.1							5.4
MET	0.6	0.1							2.1
CYS	0.7	0.2							
MET+CYS	1.4	0.3							
TRP	2.0	0.4							
ILE	1.6	0.3							5.6
VAL	3.2	0.6							5.9
LEU	2.3	0.5							8.1
PHE	0.4	0.1							5.1
TYR	1.7	0.3							
PHE+TYR	2.1	0.4							
HIS	0.4	0.1							1.9
ARG	0.9	0.2							4.6
ALA	21.5	4.4							
ASP	5.8	1.2							
GLU	110.8	22.5							
GLY	2.1	0.4							
SER	0.8	0.2							
PRO	1.3	0.3							

Vinasse, from yeast production

Moist by-product from yeast production obtained after fermentation of organic substances, particularly molasses. This product has been concentrated and demineralised (n = 331).

All values are expressed on an as fed basis unless otherwise noted.

Main constituents	mean	sd
Dry matter (%)	70.4	2.7
Crude protein (%)	46.4	3.3
Crude fibre (%)	0.0	
Ether extract (%)	0.7	
Ash (%)	8.0	2.4
Insoluble ash (%)	0.0	
Starch (%)	0.0	
Total sugars (%)	5.3	
Gross energy (MJ/kg)	13.4	

Mineral elements	mean	sd
Calcium (g/kg)	1.9	
Phosphorus (g/kg)	0.4	
Phytate P / total P (%)	10	
Magnesium (g/kg)	1.0	
Potassium (g/kg)	15.0	8.3
Sodium (g/kg)	10.1	
Chlorine (g/kg)	21.6	
Sulphur (mg/kg)	10.8	
DCAD (mEq/kg)	-458	
EB (mEq/kg)	218	
Manganese (mg/kg)	23	
Zinc (mg/kg)	97	
Copper (mg/kg)	9	
Iron (mg/kg)	180	

Pigs	Growing	Sow	
DE (MJ/kg)	10.0	10.0	
ME (MJ/kg)	9.1	9.0	
NE (MJ/kg)	5.4	5.4	
Ed (%)	75	75	
OMd (%)	75	75	
Nd (%)	75	75	
EEd (%)		75	
Ruminants			
UFL (per kg)		0.63	
UFV (per kg)		0.59	
PDIA (g/kg)		0	
PDIN (g/kg)		267	
PDIE (g/kg)		45	
ME (kcal/kg)		7.5	
Ed (%)		78	
OMd (%)		78	
Nd (%)		79	
TId (%)		100	
Absorbed phosphorus (g/kg)		0.3	
Ruminal degradation	Nitrogen	Starch	DM
Effective degradability	100		100
a (%)			
b (%)			
c (%/h)			

Amino acid content and digestibility

Amino acids	Total		Pigs				Poultry		Ruminants
	g/kg	% CP	AID %	AIDC g/kg	SID %	SIDC g/kg	TD %	TDC g/kg	AADI % PDIE
LYS	2.8	0.6							7.7
THR	1.9	0.4							5.4
MET	1.7	0.4							2.1
CYS	0.9	0.2							
MET+CYS	2.6	0.6							
TRP	1.9	0.4							
ILE	1.3	0.3							5.6
VAL	2.3	0.5							5.9
LEU	1.6	0.3							8.1
PHE	0.9	0.2							5.1
TYR	1.4	0.3							
PHE+TYR	2.3	0.5							
HIS	1.6	0.3							1.9
ARG	2.1	0.4							4.6
ALA	2.2	0.5							
ASP	4.9	1.1							
GLU	70.6	15.2							
GLY	2.2	0.5							
SER	1.9	0.4							
PRO	1.4	0.3							

Alfalfa, dehydrated, protein < 16% dry matter

Dehydrated aerial part of alfalfa (*Medicago sativa* L.), containing less than 16% protein (in dry matter) (n = 955).

All values are expressed on an as fed basis unless otherwise noted.

Main constituents	mean	sd	Fatty acids	%FA	g/kg
Dry matter (%)	91.4	1.2	Lauric acid C12:0	2.0	0.2
Crude protein (%)	13.8	0.9	Myristic acid C14:0	1.9	0.2
Crude fibre (%)	29.2	2.5	Palmitic acid C16:0	25.6	2.8
Ether extract (%)	2.2	0.5	Palmitoleic acid C16:1	1.4	0.2
Ash (%)	9.9	1.5	Stearic acid C18:0	3.8	0.4
Insoluble ash (%)	1.0		Oleic acid C18:1	4.4	0.5
Neutral detergent fibre (%)	45.9		Linoleic acid C18:2	19.3	2.1
Acid detergent fibre (%)	33.1	3.0	Linolenic acid C18:3	37.0	4.1
Acid detergent lignin (%)	8.3	2.1	Arachidic acid C20:0	3.6	0.4
Water insoluble cell walls (%)	45.3		Behenic acid C22:0	2.9	0.3
Starch (%)	0.0		Lignoceric acid C24:0	1.4	0.2
Total sugars (%)	3.2				
Gross energy (MJ/kg)	16.4	0.4	Fatty acids/ether extract (%)	50	

Mineral elements	mean	sd
Calcium (g/kg)	18.6	4.3
Phosphorus (g/kg)	2.4	0.4
Phytate P / total P (%)	5	
Magnesium (g/kg)	1.5	
Potassium (g/kg)	21.3	
Sodium (g/kg)	0.2	
Chlorine (g/kg)	5.8	
Sulphur (mg/kg)	2.4	
DCAD (mEq/kg)	238	
EB (mEq/kg)	390	
Manganese (mg/kg)	40	
Zinc (mg/kg)	21	
Copper (mg/kg)	9	
Iron (mg/kg)	315	
Selenium (mg/kg)	0.25	
Cobalt (mg/kg)	0.86	
Molybdenum (mg/kg)	1.4	

Other	mean
Xanthophylls (mg/kg)	153

Pigs	Growing	Sow	Poultry	Cockerel	Broiler
DE (MJ/kg)	6.6	7.9	AMEn (MJ/kg)	4.4	
ME (MJ/kg)	6.1	7.2	P availability (%)		85
NE (MJ/kg)	3.2	3.9	Horses		
Ed (%)	40	48	UFC (per kg)	0.52	
OMd (%)	45	53	MADC (g/kg)	78	
Nd (%)	31	45	Rabbits		
NSId (%)		57	DE (MJ/kg)	7.0	
EEd (%)		12	MEEn (MJ/kg)	6.6	
Ruminants			Ed (%)	43	
UFL (per kg)		0.60	Nd (%)	57	
UFV (per kg)		0.51	Fish		
PDIA (g/kg)		43	DE (MJ/kg)		
PDIN (g/kg)		87	Ed (%)		
PDIE (g/kg)		81	Nd (%)		
ME (kcal/kg)		7.4			
Ed (%)		56			
OMd (%)		60			
Nd (%)		65			
TId (%)		70			
FAd (%)		62			
Absorbed phosphorus (g/kg)		1.8			
<i>Ruminal degradation</i>	<i>Nitrogen</i>	<i>Starch</i>	<i>DM</i>		
Effective degradability	60		52		
a (%)	26		26		
b (%)	57		47		
c (%/h)	9.0		7.5		

Amino acid content and digestibility

Amino acids	Total		Pigs				Poultry		Ruminants
	g/kg	% CP	AID	AIDC	SID	SIDC	TD	TDC	AADI
			%	g/kg	%	g/kg	%	g/kg	% PDIE
LYS	5.8	4.2	45	2.6	52	3.0	60	3.5	6.7
THR	5.5	4.0	54	3.0	61	3.3	69	3.8	5.2
MET	1.8	1.3	67	1.2	74	1.3	74	1.3	1.8
CYS	2.0	1.5	24	0.5	35	0.7	39	0.8	
MET+CYS	3.8	2.8	47	1.8	56	2.1	55	2.1	
TRP	1.9	1.4							
ILE	4.9	3.5	62	3.0	67	3.3	74	3.6	5.2
VAL	7.5	5.4	59	4.4	66	4.9	73	5.4	6.1
LEU	8.8	6.4	66	5.8	71	6.3	78	6.9	8.3
PHE	5.6	4.1	66	3.7	71	4.0	77	4.3	5.1
TYR	3.8	2.8	58	2.2	64	2.5	62	2.4	
PHE+TYR	9.4	6.8	62	5.9	68	6.4	71	6.7	
HIS	2.8	2.0	51	1.4	55	1.6	70	2.0	2.1
ARG	5.6	4.1	66	3.7	71	4.0	80	4.5	4.7
ALA	7.2	5.2	60	4.3	67	4.8			
ASP	17.1	12.4	67	11.5	72	12.3			
GLU	12.8	9.3	62	7.9	68	8.7			
GLY	5.9	4.3	42	2.5	49	2.9			
SER	6.1	4.4	55	3.3	61	3.7			
PRO	7.1	5.2	56	4.0	64	4.5			

Alfalfa, dehydrated, protein 17-18% dry matter

Dehydrated aerial part of alfalfa (*Medicago sativa* L.), containing between 17 and 18% protein (in dry matter) (n = 1005).

All values are expressed on an as fed basis unless otherwise noted.

Main constituents	mean	sd	Fatty acids	%FA	g/kg
Dry matter (%)	90.6	1.2	Lauric acid C12:0	2.0	0.2
Crude protein (%)	15.8	0.3	Myristic acid C14:0	1.9	0.2
Crude fibre (%)	26.7	1.9	Palmitic acid C16:0	25.6	3.1
Ether extract (%)	2.5	0.6	Palmitoleic acid C16:1	1.4	0.2
Ash (%)	10.4	1.0	Stearic acid C18:0	3.8	0.5
Neutral detergent fibre (%)	43.0	3.0	Oleic acid C18:1	4.4	0.5
Acid detergent fibre (%)	30.6	2.4	Linoleic acid C18:2	19.3	2.4
Acid detergent lignin (%)	7.8	1.4	Linolenic acid C18:3	37.0	4.5
Water insoluble cell walls (%)	43.8		Arachidic acid C20:0	3.6	0.4
Starch (%)	0.0		Behenic acid C22:0	2.9	0.4
Total sugars (%)	3.8		Lignoceric acid C24:0	1.4	0.2
Gross energy (MJ/kg)	16.3	0.5			
			Fatty acids/ether extract (%)	50	

Mineral elements	mean	sd	Vitamins	mean
Calcium (g/kg)	19.7	3.6	Vitamin A (1000 UI/kg)	55
Phosphorus (g/kg)	2.4	0.3	Vitamin E (mg/kg)	122
Phytate P / total P (%)	5		Vitamin K (mg/kg)	20
Magnesium (g/kg)	1.5	0.1	Vitamin B1 - thiamin (mg/kg)	3
Potassium (g/kg)	22.8	2.8	Vitamin B2 - riboflavin (mg/kg)	12
Sodium (g/kg)	0.2		Vitamin B6 - pyridoxine (mg/kg)	285
Chlorine (g/kg)	6.0	2.8	Vitamin B12 (µg/kg)	24
Sulphur (mg/kg)	2.5		Niacin (mg/kg)	41
DCAD (mEq/kg)	266		Pantothenic acid (mg/kg)	31
EB (mEq/kg)	423		Folic acid (mg/kg)	1.5
Manganese (mg/kg)	49		Biotin (mg/kg)	0.41
Zinc (mg/kg)	19	5	Choline (%)	1417
Copper (mg/kg)	5	1		
Iron (mg/kg)	312			
Selenium (mg/kg)	0.25			
Cobalt (mg/kg)	0.85			
Molybdenum (mg/kg)	1.4			
			Other	mean
			Xanthophylls (mg/kg)	207

Pigs	Growing	Sow	Poultry	Cockerel	Broiler
DE (MJ/kg)	6.9	8.2	AMEn (MJ/kg)	4.3	
ME (MJ/kg)	6.4	7.4	P availability (%)		85
NE (MJ/kg)	3.5	4.2	Horses		
Ed (%)	43	50	UFC (per kg)	0.54	
OMd (%)	47	55	MADC (g/kg)	94	
Nd (%)	35	47	Rabbits		
EEd (%)		21	DE (MJ/kg)	7.4	
Ruminants			MEEn (MJ/kg)	6.9	
UFL (per kg)		0.62	Ed (%)	45	
UFV (per kg)		0.54	Nd (%)	58	
PDIA (g/kg)		53	Fish		
PDIN (g/kg)		103	DE (MJ/kg)	7.0	
PDIE (g/kg)		91	Ed (%)	43	
ME (kcal/kg)		7.6	Nd (%)	87	
Ed (%)		59	Pd (%)		
OMd (%)		62			
Nd (%)		68			
TId (%)		75			
FAd (%)		64			
Absorbed phosphorus (g/kg)		1.8			
<i>Ruminal degradation</i>	<i>Nitrogen</i>	<i>Starch</i>	<i>DM</i>		
Effective degradability	60		52		
a (%)			26		
b (%)			47		
c (%/h)			7.5		

Amino acid content and digestibility

Amino acids	Total		Pigs				Poultry		Ruminants
	g/kg	% CP	AID %	AIDC g/kg	SID %	SIDC g/kg	TD %	TDC g/kg	AADI % PDIE
LYS	7.2	4.5					60	4.3	6.7
THR	6.4	4.0					69	4.4	5.2
MET	2.2	1.4					74	1.7	1.8
CYS	2.2	1.4					39	0.9	
MET+CYS	4.5	2.8					57	2.5	
TRP	2.2	1.4							
ILE	6.0	3.8					74	4.5	5.2
VAL	8.7	5.5					73	6.3	6.1
LEU	10.8	6.8					78	8.4	8.5
PHE	7.0	4.4					77	5.4	5.2
TYR	4.8	3.0					62	2.9	
PHE+TYR	11.7	7.4					71	8.3	
HIS	3.4	2.1					70	2.4	2.2
ARG	6.9	4.3					80	5.5	4.7
ALA	8.5	5.4							
ASP	18.7	11.8							
GLU	14.9	9.4							
GLY	7.0	4.4							
SER	6.8	4.3							
PRO	7.8	5.0							

Alfalfa, dehydrated, protein 18-19% dry matter

Dehydrated aerial part of alfalfa (*Medicago sativa* L.), containing between 18 and 19% protein (in dry matter) (n = 1703).

All values are expressed on an as fed basis unless otherwise noted.

Main constituents	mean	sd	Fatty acids	%FA	g/kg
Dry matter (%)	90.6	1.3	Lauric acid C12:0	2.0	0.3
Crude protein (%)	16.7	0.4	Myristic acid C14:0	1.9	0.2
Crude fibre (%)	25.7	2.2	Palmitic acid C16:0	25.6	3.3
Ether extract (%)	2.6	0.6	Palmitoleic acid C16:1	1.4	0.2
Ash (%)	10.6	1.1	Stearic acid C18:0	3.8	0.5
Insoluble ash (%)	1.8		Oleic acid C18:1	4.4	0.6
Neutral detergent fibre (%)	41.8	3.7	Linoleic acid C18:2	19.3	2.5
Acid detergent fibre (%)	29.5	3.3	Linolenic acid C18:3	37.0	4.7
Acid detergent lignin (%)	7.5	1.3	Arachidic acid C20:0	3.6	0.5
Water insoluble cell walls (%)	43.3		Behenic acid C22:0	2.9	0.4
Starch (%)	0.0		Lignoceric acid C24:0	1.4	0.2
Total sugars (%)	4.2				
Gross energy (MJ/kg)	16.3	0.4	Fatty acids/ether extract (%)	50	

Mineral elements	mean	sd
Calcium (g/kg)	20.2	4.1
Phosphorus (g/kg)	2.4	0.3
Phytate P / total P (%)	5	
Magnesium (g/kg)	1.6	0.4
Potassium (g/kg)	23.5	5.4
Sodium (g/kg)	0.2	
Chlorine (g/kg)	6.1	1.9
Sulphur (mg/kg)	2.6	
DCAD (mEq/kg)	278	
EB (mEq/kg)	438	
Manganese (mg/kg)	56	
Zinc (mg/kg)	19	7
Copper (mg/kg)	5	1.0
Iron (mg/kg)	312	
Selenium (mg/kg)	0.25	
Cobalt (mg/kg)	0.85	
Molybdenum (mg/kg)	1.4	

Pigs	Growing	Sow	Poultry	Cockerel	Broiler
DE (MJ/kg)	7.2	8.4	AMEn (MJ/kg)	4.3	
ME (MJ/kg)	6.6	7.6	P availability (%)		85
NE (MJ/kg)	3.6	4.3	Horses		
Ed (%)	44	51	UFC (per kg)	0.56	
OMd (%)	48	56	MADC (g/kg)	100	
Nd (%)	37	48	Rabbits		
EEd (%)		25	DE (MJ/kg)	7.6	
Ruminants			MEEn (MJ/kg)	7.1	
UFL (per kg)		0.63	Ed (%)	47	
UFV (per kg)		0.55	Nd (%)	59	
PDIA (g/kg)		56	Fish		
PDIN (g/kg)		109	DE (MJ/kg)		
PDIE (g/kg)		94	Ed (%)		
ME (kcal/kg)		7.7	Nd (%)		
Ed (%)		60			
OMd (%)		63			
Nd (%)		69			
TId (%)		75			
FAd (%)		64			
Absorbed phosphorus (g/kg)		1.8			
Ruminal degradation	Nitrogen	Starch	DM		
Effective degradability	60		52		
a (%)			26		
b (%)			47		
c (%/h)			7.5		

Amino acid content and digestibility

Amino acids	Total		Pigs				Poultry		Ruminants
	g/kg	% CP	AID %	AIDC g/kg	SID %	SIDC g/kg	TD %	TDC g/kg	AADI % PDIE
LYS	7.7	4.6					60	4.6	6.7
THR	6.8	4.1					69	4.7	5.2
MET	2.5	1.5					74	1.8	1.8
CYS	2.3	1.4					39	0.9	
MET+CYS	4.7	2.8					57	2.7	
TRP	2.4	1.4							
ILE	6.5	3.9					74	4.8	5.2
VAL	9.2	5.5					73	6.7	6.1
LEU	11.6	7.0					78	9.1	8.5
PHE	7.5	4.5					77	5.8	5.3
TYR	5.2	3.1					62	3.2	
PHE+TYR	12.7	7.6					71	9.0	
HIS	3.6	2.2					70	2.5	2.2
ARG	7.4	4.4					80	5.9	4.8
ALA	9.0	5.4							
ASP	19.4	11.6							
GLU	15.8	9.5							
GLY	7.5	4.5							
SER	7.1	4.2							
PRO	8.2	4.9							

Alfalfa, dehydrated, protein 22-25% dry matter

Dehydrated aerial part of alfalfa (*Medicago sativa* L.), containing between 22 and 25% protein (in dry matter) (n = 473).

All values are expressed on an as fed basis unless otherwise noted.

Main constituents	mean	sd	Fatty acids	%FA	g/kg
Dry matter (%)	89.8	1.3	Lauric acid C12:0	2.0	0.3
Crude protein (%)	20.9	0.8	Myristic acid C14:0	1.9	0.3
Crude fibre (%)	18.9	2.3	Palmitic acid C16:0	25.6	3.9
Ether extract (%)	3.1	0.6	Palmitoleic acid C16:1	1.4	0.2
Ash (%)	11.6	1.6	Stearic acid C18:0	3.8	0.6
Neutral detergent fibre (%)	34.0	4.1	Oleic acid C18:1	4.4	0.7
Acid detergent fibre (%)	22.8	3.3	Linoleic acid C18:2	19.3	3.0
Acid detergent lignin (%)	6.2	1.6	Linolenic acid C18:3	37.0	5.7
Water insoluble cell walls (%)	39.7		Arachidic acid C20:0	3.6	0.6
Starch (%)	0.0		Behenic acid C22:0	2.9	0.4
Total sugars (%)	6.0		Lignoceric acid C24:0	1.4	0.2
Gross energy (MJ/kg)	16.1	0.4			
			Fatty acids/ether extract (%)	50	

Mineral elements	mean	sd	Vitamins	mean
Calcium (g/kg)	22.6	5.8	Vitamin A (1000 UI/kg)	91
Phosphorus (g/kg)	2.4	0.5	Vitamin E (mg/kg)	202
Phytate P / total P (%)	5		Vitamin K (mg/kg)	20
Magnesium (g/kg)	1.7	0.9	Vitamin B1 - thiamin (mg/kg)	4
Potassium (g/kg)	26.6	9.7	Vitamin B2 - riboflavin (mg/kg)	17
Sodium (g/kg)	0.2		Vitamin B6 - pyridoxine (mg/kg)	283
Chlorine (g/kg)	6.5		Vitamin B12 (µg/kg)	23
Sulphur (mg/kg)	2.7		Niacin (mg/kg)	50
DCAD (mEq/kg)	335		Pantothenic acid (mg/kg)	40
EB (mEq/kg)	506		Folic acid (mg/kg)	3
Manganese (mg/kg)	37		Biotin (mg/kg)	0.40
Zinc (mg/kg)	26	8	Choline (%)	1405
Copper (mg/kg)	7	1		
Iron (mg/kg)	309			
Selenium (mg/kg)	0.24			
Cobalt (mg/kg)	0.84			
Molybdenum (mg/kg)	1.4			
			Other	mean
			Xanthophylls (mg/kg)	339

Pigs	Growing	Sow	Poultry	Cockerel	Broiler
DE (MJ/kg)	8.2	9.3	AMEn (MJ/kg)	4.4	
ME (MJ/kg)	7.6	8.4	P availability (%)		85
NE (MJ/kg)	4.5	5.0	Horses		
Ed (%)	51	58	UFC (per kg)	0.63	
OMd (%)	55	62	MADC (g/kg)	131	
Nd (%)	48	55	Rabbits		
NSId (%)		63	DE (MJ/kg)	8.8	
EEEd (%)		39	MEEn (MJ/kg)	8.1	
Ruminants			Ed (%)	55	
UFL (per kg)		0.70	Nd (%)	64	
UFV (per kg)		0.64	Fish		
PDIA (g/kg)		74	DE (MJ/kg)		
PDIN (g/kg)		141	Ed (%)		
PDIE (g/kg)		114	Nd (%)		
ME (kcal/kg)		8.4			
Ed (%)		67			
OMd (%)		70			
Nd (%)		73			
TId (%)		80			
FAd (%)		67			
Absorbed phosphorus (g/kg)		1.8			
Ruminal degradation	Nitrogen	Starch	DM		
Effective degradability	60		52		
a (%)			26		
b (%)			47		
c (%/h)			7.5		

Amino acid content and digestibility

Amino acids	Total		Pigs				Poultry		Ruminants
	g/kg	% CP	AID	AIDC	SID	SIDC	TD	TDC	AADI
			%	g/kg	%	g/kg	%	g/kg	% PDIE
LYS	10.5	5.0	63	6.6	67	7.0	60	6.3	6.8
THR	8.7	4.2	65	5.6	69	6.0	69	6.0	5.1
MET	3.4	1.6	73	2.5	77	2.7	74	2.5	1.8
CYS	2.6	1.3					39	1.0	
MET+CYS	6.1	2.9					59	3.6	
TRP	3.0	1.4	40	1.2	46	1.4			
ILE	8.8	4.2	70	6.2	73	6.5	74	6.5	5.3
VAL	11.7	5.6	66	7.6	70	8.1	73	8.5	6.1
LEU	15.7	7.5	72	11.2	75	11.8	78	12.2	8.8
PHE	10.2	4.9	70	7.2	74	7.6	77	7.9	5.5
TYR	7.1	3.4	69	4.9	73	5.2	62	4.4	
PHE+TYR	17.3	8.3	70	12.0	73	12.7	71	12.3	
HIS	4.8	2.3	62	3.0	65	3.1	70	3.3	2.3
ARG	9.9	4.7	79	7.8	82	8.2	80	7.9	4.8
ALA	11.6	5.5	67	7.8	72	8.3			
ASP	22.7	10.9	78	17.8	81	18.3			
GLU	20.1	9.6	68	13.8	73	14.7			
GLY	9.8	4.7	51	5.0	56	5.5			
SER	8.6	4.1	64	5.5	68	5.8			
PRO	9.7	4.6							

Grass, dehydrated

Dehydrated grass (n = 79).

All values are expressed on an as fed basis unless otherwise noted.

Main constituents	mean	sd	Fatty acids	%FA	g/kg
Dry matter (%)	89.6	2.9	Lauric acid C12:0	0.2	0.0
Crude protein (%)	15.0	3.3	Myristic acid C14:0	2.0	0.3
Crude fibre (%)	23.3	3.0	Palmitic acid C16:0	23.5	3.6
Ether extract (%)	3.1	0.9	Palmitoleic acid C16:1	2.0	0.3
Ash (%)	7.8	2.5	Stearic acid C18:0	4.3	0.7
Insoluble ash (%)	2.0	0.9	Oleic acid C18:1	6.0	0.9
Neutral detergent fibre (%)	48.6	5.7	Linoleic acid C18:2	18.6	2.9
Acid detergent fibre (%)	27.5	3.2	Linolenic acid C18:3	40.8	6.3
Acid detergent lignin (%)	3.2	1.2			
Starch (%)	0.0		Fatty acids/ether extract (%)	50	
Total sugars (%)	9.1	4.5			
Gross energy (MJ/kg)	16.7	0.8			

Mineral elements	mean	sd	Vitamins	mean
Calcium (g/kg)	5.4	1.1	Vitamin E (mg/kg)	109
Phosphorus (g/kg)	2.8	0.4	Vitamin B1 - thiamin (mg/kg)	5
Phytate P / total P (%)	5		Vitamin B2 - riboflavin (mg/kg)	10
Magnesium (g/kg)	1.7	0.4	Vitamin B6 - pyridoxine (mg/kg)	9
Potassium (g/kg)	21.0	6.5	Niacin (mg/kg)	77
Sodium (g/kg)	3.9	1.5	Pantothenic acid (mg/kg)	18
Chlorine (g/kg)	7.8		Biotin (mg/kg)	0.22
Sulphur (mg/kg)	1.0		Choline (%)	1448
DCAD (mEq/kg)	424			
EB (mEq/kg)	490			
Manganese (mg/kg)	49	17		
Zinc (mg/kg)	32	7		
Copper (mg/kg)	7	1.0		
Iron (mg/kg)	525			
Selenium (mg/kg)	0.20	0.08		
Cobalt (mg/kg)	0.52			
Molybdenum (mg/kg)	2			
Iodine (mg/kg)	0.65			

Pigs	Growing	Sow	Poultry	Cockerel	Broiler
DE (MJ/kg)	6.4	7.8	AMEn (MJ/kg)		
ME (MJ/kg)	5.9	7.0	P availability (%)		
NE (MJ/kg)	3.5	4.2	Horses		
Ed (%)	38	46	UFC (per kg)	0.59	
OMd (%)	43	51	MADC (g/kg)	87	
Nd (%)	46	59	Rabbits		
EEd (%)		30	DE (MJ/kg)	8.1	
Ruminants			MEEn (MJ/kg)	7.6	
UFL (per kg)		0.80	Ed (%)	48	
UFV (per kg)		0.74	Nd (%)	61	
PDIA (g/kg)		53	Fish		
PDIN (g/kg)		101	DE (MJ/kg)		
PDIE (g/kg)		100	Ed (%)		
ME (kcal/kg)		9.4	Nd (%)		
Ed (%)		70			
OMd (%)		73			
Nd (%)		72			
TId (%)		80			
FAd (%)		67			
Absorbed phosphorus (g/kg)		2.1			
<i>Ruminal degradation</i>	<i>Nitrogen</i>	<i>Starch</i>	<i>DM</i>		
Effective degradability	60		52		
a (%)					
b (%)					
c (%/h)					

Amino acid content and digestibility

Amino acids	Total		Pigs				Poultry		Ruminants
	g/kg	% CP	AID %	AIDC g/kg	SID %	SIDC g/kg	TD %	TDC g/kg	AADI % PDIE
LYS	6.2	4.1							6.7
THR	5.8	3.8							5.2
MET	2.1	1.4							1.8
CYS	1.3	0.9							
MET+CYS	3.4	2.3							
TRP	2.1	1.4							
ILE	6.0	4.0							5.4
VAL	7.6	5.1							6.1
LEU	10.2	6.8							8.6
PHE	6.7	4.5							5.4
TYR	3.5	2.3							
PHE+TYR	10.2	6.8							
HIS	3.4	2.3							2.3
ARG	6.2	4.1							4.7
ALA	8.2	5.5							
ASP	14.2	9.5							
GLU	14.8	9.9							
GLY	6.8	4.5							
SER	5.8	3.8							
PRO	7.7	5.2							

Wheat straw

Wheat straw, untreated (n = 236).

All values are expressed on an as fed basis unless otherwise noted.

Main constituents	mean	sd
Dry matter (%)	91.4	1.5
Crude protein (%)	3.8	0.8
Crude fibre (%)	38.2	2.6
Ether extract (%)	1.3	0.4
Ash (%)	5.9	1.4
Insoluble ash (%)	2.6	1.3
Neutral detergent fibre (%)	72.1	4.2
Acid detergent fibre (%)	45.8	3.5
Acid detergent lignin (%)	7.5	1.4
Starch (%)	0.7	1.0
Total sugars (%)	1.5	1.6
Gross energy (MJ/kg)	16.9	0.8

Mineral elements	mean	sd	Vitamins	mean
Calcium (g/kg)	4.4	1.2	Vitamin A (1000 UI/kg)	0.90
Phosphorus (g/kg)	0.7	0.3	Vitamin D (1000 UI/kg)	0.64
Phytate P / total P (%)	5			
Magnesium (g/kg)	0.6			
Potassium (g/kg)	9.4	3.4		
Sodium (g/kg)	0.3	1.1		
Chlorine (g/kg)	5.5			
Sulphur (mg/kg)	1.0			
DCAD (mEq/kg)	37			
EB (mEq/kg)	100			
Manganese (mg/kg)	42			
Zinc (mg/kg)	19			
Copper (mg/kg)	3			
Iron (mg/kg)	171			
Molybdenum (mg/kg)	1.2			

Pigs	Growing	Sow	Poultry	Cockerel	Broiler
DE (MJ/kg)	2.0	3.1	AMEn (MJ/kg)		
ME (MJ/kg)	1.8	2.8	P availability (%)		
NE (MJ/kg)	1.0	1.5			
Ed (%)	12	19	Horses		
OMd (%)	12	18	UFC (per kg)	0.26	
Nd (%)	0	42	MADC (g/kg)	0	
EEd (%)		0			
Ruminants			Rabbits		
UFL (per kg)		0.43	DE (MJ/kg)	2.8	
UFV (per kg)		0.33	MEEn (MJ/kg)	2.7	
PDIA (g/kg)		11	Ed (%)	16	
PDIN (g/kg)		23	Nd (%)	15	
PDIE (g/kg)		44	Fish		
ME (kcal/kg)		5.7	DE (MJ/kg)		
Ed (%)		41	Ed (%)		
OMd (%)		44	Nd (%)		
Nd (%)		-5			
TId (%)		65			
Absorbed phosphorus (g/kg)		0.3			
<i>Ruminal degradation</i>	<i>Nitrogen</i>	<i>Starch</i>	<i>DM</i>		
Effective degradability	60		18		
a (%)			0		
b (%)			50		
c (%/h)			3.5		

Milk powder, skimmed

Dried skimmed milk (n = 47).

All values are expressed on an as fed basis unless noted otherwise.

Main constituents	mean	sd	Fatty acids	%FA	g/kg
Dry matter (%)	94.7	1.6	Sum C6 + C8 + C10	8.5	1.3
Crude protein (%)	34.1	2.3	Lauric acid C12:0	2.8	0.4
Ether extract (hydrolysis) (%)	1.6	0.6	Myristic acid C14:0	10.8	1.7
Ash (%)	8.2	0.5	Palmitic acid C16:0	27.6	4.3
Lactose (%)	47.8		Palmitoleic acid C16:1	3.6	0.6
Gross energy (MJ/kg)	17.3	0.5	Stearic acid C18:0	10.8	1.7
			Oleic acid C18:1	27.2	4.2
			Linoleic acid C18:2	2.1	0.3
			Linolenic acid C18:3	1.1	0.2
			Fatty acids/ether extract (%)	95	

Mineral elements	mean	sd	Vitamins	mean
Calcium (g/kg)	14.7	2.8	Vitamin A (1000 UI/kg)	0.29
Phosphorus (g/kg)	10.2	2.0	Vitamin D (1000 UI/kg)	0.01
Magnesium (g/kg)	1.1		Vitamin E (mg/kg)	2
Potassium (g/kg)	15.6		Vitamin B1 - thiamin (mg/kg)	4
Sodium (g/kg)	5.7		Vitamin B2 - riboflavin (mg/kg)	20
Chlorine (g/kg)	9.4		Vitamin B6 - pyridoxine (mg/kg)	3
Sulphur (mg/kg)	3.0		Vitamin B12 (µg/kg)	29
DCAD (mEq/kg)	194		Niacin (mg/kg)	11
EB (mEq/kg)	384		Pantothenic acid (mg/kg)	35
Manganese (mg/kg)	2		Folic acid (mg/kg)	0.34
Zinc (mg/kg)	43		Biotin (mg/kg)	0.19
Copper (mg/kg)	3		Vitamin C (mg/kg)	22
Iron (mg/kg)	7		Choline (%)	1374
Selenium (mg/kg)	0.14			
Cobalt (mg/kg)	0.01			
Molybdenum (mg/kg)	0.24			
Iodine (mg/kg)	0.82			

Pigs	Growing	Sow	Poultry	Cockerel	Broiler
DE (MJ/kg)	16.4	16.4	AMEn (MJ/kg)	11.7	11.7
ME (MJ/kg)	15.5	15.5	P availability (%)		
NE (MJ/kg)	11.3	11.3	Horses		
Ed (%)	95	95	UFC (per kg)		
OMd (%)	98	98	MADC (g/kg)		
Nd (%)	95	95	Rabbits		
NSId (%)		89	DE (MJ/kg)		
EEEd (%)		85	MEEn (MJ/kg)		
Pd (%)		90	Ed (%)		
Ruminants			Nd (%)		
UFL (per kg)		1.15	Fish		
UFV (per kg)		1.17	DE (MJ/kg)	15.9	
PDIA (g/kg)		0	Ed (%)	92	
PDIN (g/kg)		196	Nd (%)	95	
PDIE (g/kg)		75	Pd (%)		
ME (kcal/kg)		12.7			
Ed (%)		93			
OMd (%)		95			
Nd (%)		80			
TId (%)		95			
FAd (%)		66			
Absorbed phosphorus (g/kg)		8.5			
Ruminal degradation	Nitrogen	Starch	DM		
Effective degradability	100	100			
a (%)					
b (%)					
c (%/h)					

Amino acid content and digestibility

Amino acids	Total		Pigs				Poultry		Ruminants
	g/kg	% CP	AID	AIDC	SID	SIDC	TD	TDC	AADI
			%	g/kg	%	g/kg	%	g/kg	% PDIE
LYS	26.8	7.9	95	25.6	97	26.0			7.7
THR	14.9	4.4	88	13.1	91	13.5			5.4
MET	9.7	2.8	95	9.2	97	9.4			2.1
CYS	2.7	0.8	78	2.1	84	2.3			
MET+CYS	12.4	3.6	91	11.2	94	11.6			
TRP	4.4	1.3							
ILE	18.6	5.5	87	16.1	88	16.4			5.6
VAL	21.0	6.2	87	18.3	89	18.7			5.9
LEU	31.9	9.4	95	30.3	96	30.7			8.1
PHE	16.4	4.8	96	15.7	98	16.0			5.1
TYR	14.5	4.2	96	13.8	97	14.0			
PHE+TYR	30.9	9.1	96	29.5	97	30.1			
HIS	9.4	2.8	94	8.8	95	9.0			1.9
ARG	12.5	3.7	94	11.7	96	12.0			4.6
ALA	11.3	3.3	85	9.5	89	10.0			
ASP	26.1	7.7	90	23.5	93	24.2			
GLU	70.2	20.6	86	60.6	87	61.4			
GLY	6.6	1.9	77	5.0	83	5.5			
SER	18.6	5.5	76	14.2	79	14.6			
PRO	33.9	10.0	94	32.0	96	32.5			

Milk powder, whole

Dried whole milk (n = 13).

All values are expressed on an as fed basis unless noted otherwise.

Main constituents	mean	sd	Fatty acids	%FA	g/kg
Dry matter (%)	96.4	1.3	Sum C6 + C8 + C10	8.5	20.8
Crude protein (%)	23.4	2.6	Lauric acid C12:0	2.8	6.9
Ether extract (hydrolysis) (%)	25.8	1.1	Myristic acid C14:0	10.8	26.5
Ash (%)	6.0	1.0	Palmitic acid C16:0	27.6	67.6
Lactose (%)	35.4	3.7	Palmitoleic acid C16:1	3.6	8.8
Gross energy (MJ/kg)	22.7		Stearic acid C18:0	10.8	26.5
			Oleic acid C18:1	27.2	66.6
			Linoleic acid C18:2	2.1	5.1
			Linolenic acid C18:3	1.1	2.7
			Fatty acids/ether extract (%)	95	

Mineral elements	mean	sd	Vitamins	mean
Calcium (g/kg)	12.0		Vitamin A (1000 UI/kg)	9,17
Phosphorus (g/kg)	7.6		Vitamin D (1000 UI/kg)	0.32
Magnesium (g/kg)	1.0		Vitamin E (mg/kg)	6
Potassium (g/kg)	13.4		Vitamin K (mg/kg)	0.55
Sodium (g/kg)	3.9		Vitamin B1 - thiamin (mg/kg)	3
Chlorine (g/kg)	7.8		Vitamin B2 - riboflavin (mg/kg)	13
Sulphur (mg/kg)	2.4		Vitamin B6 - pyridoxine (mg/kg)	2
DCAD (mEq/kg)	143		Vitamin B12 (µg/kg)	23
EB (mEq/kg)	294		Niacin (mg/kg)	7
Manganese (mg/kg)	1.1		Pantothenic acid (mg/kg)	26
Zinc (mg/kg)	33		Folic acid (mg/kg)	0.40
Copper (mg/kg)	1.5		Biotin (mg/kg)	0.24
Iron (mg/kg)	7		Vitamin C (mg/kg)	80
Selenium (mg/kg)	0.20			
Cobalt (mg/kg)	0.01			
Molybdenum (mg/kg)	0.40			
Iodine (mg/kg)	0.69			

Pigs	Growing	Sow	
DE (MJ/kg)	21.1	21.1	
ME (MJ/kg)	20.4	20.3	
NE (MJ/kg)	16.1	16.1	
Ed (%)	93	93	
OMd (%)	94	94	
Nd (%)	95	95	
NSId (%)		90	
EEd (%)		85	
Pd (%)		90	
Ruminants			
UFL (per kg)		1.65	
UFV (per kg)		1.70	
PDIA (g/kg)		0	
PDIN (g/kg)		135	
PDIE (g/kg)		56	
ME (kcal/kg)		17.8	
Ed (%)		97	
OMd (%)		95	
Nd (%)		78	
TId (%)		95	
FAd (%)		78	
Absorbed phosphorus (g/kg)		6.3	
Ruminal degradation	Nitrogen	Starch	DM
Effective degradability	100		100
a (%)			
b (%)			
c (%/h)			

Amino acid content and digestibility

Amino acids	Total		Pigs				Poultry		Ruminants
	g/kg	% CP	AID	AIDC	SID	SIDC	TD	TDC	AADI
			%	g/kg	%	g/kg	%	g/kg	% PDIE
LYS	18.1	7.7	88	15.9	89	16.0			7.7
THR	10.4	4.5	92	9.6	94	9.8			5.4
MET	5.4	2.3	95	5.2	96	5.2			2.1
CYS	1.5	0.6	91	1.3	95	1.4			
MET+CYS	6.9	2.9	94	6.5	96	6.6			
TRP	3.1	1.3	95	2.9	97	3.0			
ILE	12.8	5.5	88	11.2	89	11.4			5.6
VAL	13.7	5.8	91	12.4	92	12.6			5.9
LEU	21.2	9.1	96	20.4	97	20.6			8.1
PHE	10.9	4.7	97	10.6	98	10.8			5.1
TYR	8.3	3.5	97	8.1	98	8.2			
PHE+TYR	19.2	8.2	97	18.7	98	18.9			
HIS	6.7	2.9	95	6.4	97	6.5			1.9
ARG	8.2	3.5	86	7.1	88	7.2			4.6
ALA	7.0	3.0	87	6.0	90	6.2			
ASP	16.1	6.9	92	14.8	94	15.0			
GLU	46.2	19.7	90	41.6	91	42.0			
GLY	4.5	1.9	86	3.8	93	4.1			
SER	12.1	5.2	79	9.5	80	9.7			
PRO	13.8	5.9							

Whey powder, acid

Dried whey from soft or fresh cheese production. Whey is the liquid that separates from the curd (n = 114).

All values are expressed on an as fed basis unless noted otherwise.

Main constituents	mean	sd	Fatty acids	%FA	g/kg
Dry matter (%)	98.0	1.7	Sum C6 + C8 + C10	9.0	1.8
Crude protein (%)	9.7	1.6	Lauric acid C12:0	1.2	0.2
Ether extract (hydrolysis) (%)	2.1	0.8	Myristic acid C14:0	9.0	1.8
Ash (%)	11.8	1.0	Palmitic acid C16:0	29.3	5.9
Lactose (%)	63.0	2.9	Palmitoleic acid C16:1	5.1	1.0
Gross energy (MJ/kg)	15.1		Stearic acid C18:0	11.7	2.4
			Oleic acid C18:1	22.3	4.5
			Linoleic acid C18:2	3.5	0.7
			Linolenic acid C18:3	0.6	0.1
			Fatty acids/ether extract (%)	95	

Mineral elements	mean	sd	Vitamins	mean
Calcium (g/kg)	16.9	2.3	Vitamin A (1000 UI/kg)	0.53
Phosphorus (g/kg)	10.1		Vitamin E (mg/kg)	0.49
Magnesium (g/kg)	1.5		Vitamin B1 - thiamin (mg/kg)	4
Potassium (g/kg)	21.0		Vitamin B2 - riboflavin (mg/kg)	27
Sodium (g/kg)	7.0	1.0	Vitamin B6 - pyridoxine (mg/kg)	5
Chlorine (g/kg)	21.2	7.5	Vitamin B12 (µg/kg)	23
Sulphur (mg/kg)	4.7		Niacin (mg/kg)	10
DCAD (mEq/kg)	-52		Pantothenic acid (mg/kg)	85
EB (mEq/kg)	245		Folic acid (mg/kg)	0.64
Manganese (mg/kg)	3		Biotin (mg/kg)	0.38
Zinc (mg/kg)	64		Vitamin C (mg/kg)	15
Copper (mg/kg)	1.6		Choline (%)	1950
Iron (mg/kg)	9			
Selenium (mg/kg)	0.20			
Cobalt (mg/kg)	0.10			
Molybdenum (mg/kg)	5			

Pigs	Growing	Sow	Poultry	Cockerel	Broiler
DE (MJ/kg)	14.4	14.4	AMEn (MJ/kg)		
ME (MJ/kg)	13.9	13.9	P availability (%)		
NE (MJ/kg)	11.4	11.3			
Ed (%)	95	95	Horses		
OMd (%)	99	99	UFC (per kg)		
Nd (%)	95	95	MADC (g/kg)		
NSId (%)		81			
EEEd (%)		85	Rabbits		
Pd (%)		90	DE (MJ/kg)		
			MEEn (MJ/kg)		
Ruminants			Ed (%)		
UFL (per kg)		1.06	Nd (%)		
UFV (per kg)		1.09			
PDIA (g/kg)		0	Fish		
PDIN (g/kg)		56	DE (MJ/kg)	13.1	
PDIE (g/kg)		73	DE extruded (MJ/kg)		
ME (kcal/kg)		11.6	Ed (%)	86	
Ed (%)		91	Nd (%)	88	
OMd (%)		94	Pd (%)		
Nd (%)		72			
TId (%)		95			
FAd (%)		69			
Absorbed phosphorus (g/kg)		8.4			
Ruminal degradation	Nitrogen	Starch	DM		
Effective degradability	100	100			
a (%)					
b (%)					
c (%/h)					

Amino acid content and digestibility

Amino acids	Total		Pigs				Poultry		Ruminants
	g/kg	% CP	AId	AIDC	SID	SIDC	TD	TDC	AADI
			%	g/kg	%	g/kg	%	g/kg	% PDIE
LYS	7.2	7.4	86	6.2	89	6.4			7.7
THR	5.4	5.5	81	4.4	85	4.6			5.4
MET	1.5	1.5	88	1.3	92	1.4			2.1
CYS	1.7	1.7	83	1.4	88	1.5			
MET+CYS	3.2	3.3	85	2.7	90	2.8			
TRP	1.2	1.2	83	1.0	87	1.0			
ILE	5.2	5.4	84	4.4	88	4.6			5.6
VAL	4.8	5.0	82	3.9	87	4.2			5.9
LEU	7.7	8.0	87	6.7	91	7.0			8.1
PHE	2.7	2.7	81	2.2	90	2.4			5.1
TYR	1.4	1.5	79	1.1	90	1.3			
PHE+TYR	4.1	4.2	81	3.3	90	3.7			
HIS	1.9	1.9	83	1.6	91	1.7			1.9
ARG	2.1	2.1	78	1.6	88	1.8			4.6
ALA	3.8	3.9	77	3.0	84	3.2			
ASP	8.4	8.7	85	7.1	89	7.5			
GLU	14.6	15.0	87	12.8	91	13.4			
GLY	1.8	1.8	57	1.0	75	1.3			
SER	4.1	4.3	74	3.1	81	3.4			
PRO	3.5	3.6	79	2.8	87	3.0			

Whey powder, sweet

Dried whey from pressed cheese production. Whey is the liquid that separates from the curd (n = 42).

All values are expressed on an as fed basis unless noted otherwise.

Main constituents	mean	sd	Fatty acids	%FA	g/kg
Dry matter (%)	96.4	2.1	Sum C6 + C8 + C10	9.5	1.9
Crude protein (%)	12.6	2.3	Lauric acid C12:0	1.2	0.2
Ether extract (hydrolysis) (%)	2.1	0.9	Myristic acid C14:0	10.2	2.0
Ash (%)	8.7	2.1	Palmitic acid C16:0	32.1	6.4
Lactose (%)	72.9		Palmitoleic acid C16:1	3.3	0.6
Gross energy (MJ/kg)	15.6		Stearic acid C18:0	9.6	1.9
			Oleic acid C18:1	24.7	4.9
			Linoleic acid C18:2	2.5	0.5
			Linolenic acid C18:3	0.9	0.2
			Fatty acids/ether extract (%)	95	

Mineral elements	mean	sd
Calcium (g/kg)	8.2	1.5
Phosphorus (g/kg)	6.9	0.7
Magnesium (g/kg)	1.4	
Potassium (g/kg)	20.2	
Sodium (g/kg)	6.4	
Chlorine (g/kg)	17.6	
Sulphur (mg/kg)	4.7	
DCAD (mEq/kg)	10	
EB (mEq/kg)	302	
Manganese (mg/kg)	3	
Zinc (mg/kg)	20	
Copper (mg/kg)	2	
Iron (mg/kg)	10	
Selenium (mg/kg)	0.30	
Cobalt (mg/kg)	0.10	
Molybdenum (mg/kg)	5	

Pigs	Growing	Sow	
DE (MJ/kg)	14.8	14.8	
ME (MJ/kg)	14.4	14.3	
NE (MJ/kg)	12.0	11.8	
Ed (%)	95	95	
OMd (%)	99	99	
Nd (%)	95	95	
NSId (%)		81	
EEd (%)		85	
Pd (%)		90	
Ruminants			
UFL (per kg)		1.09	
UFV (per kg)		1.11	
PDIA (g/kg)		0	
PDIN (g/kg)		73	
PDIE (g/kg)		75	
ME (kcal/kg)		11.9	
Ed (%)		91	
OMd (%)		94	
Nd (%)		74	
TId (%)		95	
FAd (%)		69	
Absorbed phosphorus (g/kg)		5.7	
Ruminal degradation	Nitrogen	Starch	DM
Effective degradability	100		100
a (%)			
b (%)			
c (%/h)			

Amino acid content and digestibility

Amino acids	Total		Pigs				Poultry		Ruminants
	g/kg	% CP	AID	AIDC	SID	SIDC	TD	TDC	AADI
			%	g/kg	%	g/kg	%	g/kg	% PDIE
LYS	9.4	7.4	86	8.1	89	8.4			7.7
THR	7.2	5.7	81	5.8	85	6.1			5.4
MET	2.0	1.6	88	1.8	92	1.9			2.1
CYS	2.2	1.7	83	1.8	88	1.9			
MET+CYS	4.2	3.3	85	3.6	90	3.8			
TRP	1.6	1.3	83	1.4	87	1.4			
ILE	6.9	5.5	84	5.8	88	6.1			5.6
VAL	6.5	5.1	82	5.3	87	5.6			5.9
LEU	10.5	8.4	87	9.2	91	9.6			8.1
PHE	3.6	2.9	81	2.9	90	3.3			5.1
TYR	2.1	1.7	79	1.7	90	1.9			
PHE+TYR	5.7	4.5	80	4.6	90	5.2			
HIS	2.4	1.9	83	2.0	91	2.2			1.9
ARG	2.8	2.3	78	2.2	88	2.5			4.6
ALA	5.1	4.0	77	3.9	84	4.3			
ASP	11.1	8.8	85	9.4	89	9.9			
GLU	19.6	15.5	87	17.1	91	17.9			
GLY	2.3	1.8	57	1.3	75	1.7			
SER	5.7	4.5	74	4.2	81	4.6			
PRO	4.5	3.6	79	3.6	87	4.0			

Fish meal, protein 62%

Product obtained by processing whole or parts of fish, containing 58-63% protein (as fed) (n = 297).

All values are expressed on an as fed basis unless noted otherwise.

Main constituents	mean	sd	Fatty acids	%FA	g/kg
Dry matter (%)	94.3	1.9	Myristic acid C14:0	6.0	4.1
Crude protein (%)	62.6	1.7	Palmitic acid C16:0	17.8	12.3
Ether extract (%)	8.9	1.8	Palmitoleic acid C16:1	7.2	5.0
Ether extract (hydrolysis) (%)	9.2	2.0	Stearic acid C18:0	3.6	2.5
Ash (%)	20.8	2.7	Oleic acid C18:1	12.3	8.5
Insoluble ash (%)	0.3	0.2	Linoleic acid C18:2	2.1	1.4
Gross energy (MJ/kg)	18.3		Linolenic acid C18:3	1.9	1.3
			Steradonic acid C 18:4	1.5	1.0
			Eicosenoic acid C20:1	6.6	4.5
			Arachidonic acid C20:4	2.4	1.7
			Eicosapentaenoic acid C20:5	9.0	6.2
			Erucic acid C22:1	7.7	5.3
			Clupanodonic acid C22:5	2.6	1.8
			Docosahexaneic acid C22:6	6.6	4.5
			Fatty acids/ether extract (%)	75	

Mineral elements	mean	sd	Vitamins	mean
Calcium (g/kg)	55.4	11.9	Vitamin E (mg/kg)	9
Phosphorus (g/kg)	31.0	4.9	Vitamin B1 - thiamin (mg/kg)	1.7
Magnesium (g/kg)	2.6	0.5	Vitamin B2 - riboflavin (mg/kg)	9
Potassium (g/kg)	7.4	1.8	Vitamin B6 - pyridoxine (mg/kg)	6
Sodium (g/kg)	11.2	2.9	Vitamin B12 (µg/kg)	92
Chlorine (g/kg)	16.3	4.8	Niacin (mg/kg)	60
Sulphur (mg/kg)	7.4		Pantothenic acid (mg/kg)	10
DCAD (mEq/kg)	-245		Folic acid (mg/kg)	0.38
EB (mEq/kg)	216		Biotin (mg/kg)	0.13
Manganese (mg/kg)	23	14	Choline (%)	4311
Zinc (mg/kg)	89	5		
Copper (mg/kg)	9			
Iron (mg/kg)	469	412		
Selenium (mg/kg)	0.41			
Cobalt (mg/kg)	0.09			
Molybdenum (mg/kg)	0.10			
Iodine (mg/kg)	3			

Pigs	Growing	Sow	Poultry	Cockerel	Broiler
DE (MJ/kg)	15.6	15.6	AMEn (MJ/kg)	12.6	12.6
ME (MJ/kg)	14.1	14.1	P availability (%)		85
NE (MJ/kg)	9.2	9.1	Fish		
Ed (%)	85	85	DE (MJ/kg)	15.2	
OMd (%)	85	85	Ed (%)	83	
Nd (%)	85	85	Nd (%)	88	
EEd (%)	85		Pd (%)	38	
Pd (%)	77				

Amino acid content and digestibility

Amino acids	Total		Pigs				Poultry	
	g/kg	% CP	AID %	AIDC g/kg	SID %	SIDC g/kg	TD %	TDC g/kg
LYS	46.4	7.4					89	41.3
THR	25.6	4.1					91	23.3
MET	16.3	2.6					92	15.0
CYS	5.1	0.8					79	4.1
MET+CYS	21.5	3.4					89	19.1
TRP	6.0	1.0						
ILE	25.0	4.0					93	23.3
VAL	30.2	4.8					92	27.8
LEU	44.5	7.1					93	41.4
PHE	24.3	3.9					92	22.3
TYR	19.0	3.0					85	16.1
PHE+TYR	43.3	6.9					89	38.5
HIS	15.9	2.5					89	14.1
ARG	38.2	6.1					93	35.5
ALA	39.7	6.3						
ASP	57.7	9.2					82	47.3
GLU	77.3	12.3					90	69.5
GLY	48.0	7.7						
SER	24.5	3.9					82	20.1
PRO	28.3	4.5						

Fish meal, protein 65%

Product obtained by processing whole or parts of fish, containing 63-68% protein (as fed) (n = 1198).

All values are expressed on an as fed basis unless noted otherwise.

Main constituents	mean	sd	Fatty acids	%FA	g/kg
Dry matter (%)	91.7	1.4	Myristic acid C14:0	6.0	4.3
Crude protein (%)	65.3	1.8	Palmitic acid C16:0	17.8	12.7
Ether extract (%)	8.9	1.4	Palmitoleic acid C16:1	7.2	5.1
Ether extract (hydrolysis) (%)	9.5	1.6	Stearic acid C18:0	3.6	2.6
Ash (%)	16.2	2.1	Oleic acid C18:1	12.3	8.8
Insoluble ash (%)	0.2	0.1	Linoleic acid C18:2	2.1	1.5
Gross energy (MJ/kg)	19.0	1.1	Linolenic acid C18:3	1.9	1.4
			Steradonic acid C 18:4	1.5	1.1
			Eicosenoic acid C20:1	6.6	4.7
			Arachidonic acid C20:4	2.4	1.7
			Eicosapentaenoic acid C20:5	9.0	6.4
			Erucic acid C22:1	7.7	5.5
			Clupanodonic acid C22:5	2.6	1.9
			Docosahexaneic acid C22:6	6.6	4.7
			Fatty acids/ether extract (%)	75	

Mineral elements	mean	sd	Vitamins	mean
Calcium (g/kg)	38.5	8.2	Vitamin E (mg/kg)	5
Phosphorus (g/kg)	25.2	3.0	Vitamin B1 - thiamin (mg/kg)	0.20
Magnesium (g/kg)	2.2	0.4	Vitamin B2 - riboflavin (mg/kg)	7
Potassium (g/kg)	9.7	7.8	Vitamin B6 - pyridoxine (mg/kg)	4
Sodium (g/kg)	11.3	2.7	Vitamin B12 (µg/kg)	310
Chlorine (g/kg)	17.7	6.0	Niacin (mg/kg)	116
Sulphur (mg/kg)	7.1		Pantothenic acid (mg/kg)	12
DCAD (mEq/kg)	-200		Folic acid (mg/kg)	0.27
EB (mEq/kg)	244		Biotin (mg/kg)	0.20
Manganese (mg/kg)	13	7	Choline (%)	3792
Zinc (mg/kg)	85	14		
Copper (mg/kg)	7	1.0		
Iron (mg/kg)	351	132		
Selenium (mg/kg)	0.40			
Cobalt (mg/kg)	0.09			
Molybdenum (mg/kg)	0.21			
Iodine (mg/kg)	2			

Pigs	Growing	Sow	Poultry	Cockerel	Broiler
DE (MJ/kg)	16.1	16.1	AMEn (MJ/kg)	13.5	13.5
ME (MJ/kg)	14.6	14.6	P availability (%)		85
NE (MJ/kg)	9.5	9.4	Fish		
Ed (%)	85	85	DE (MJ/kg)	16.4	
OMd (%)	85	85	Ed (%)	86	
Nd (%)	85	85	Nd (%)	90	
NSId (%)		89	Pd (%)	47	
EEEd (%)		85			
Pd (%)		77			

Amino acid content and digestibility

Amino acids	Total		Pigs				Poultry	
	g/kg	% CP	AID	AIDC	SID	SIDC	TD	TDC
			%	g/kg	%	g/kg	%	g/kg
LYS	48.9	7.5	93	45.3	93	45.6	89	43.5
THR	27.0	4.1	91	24.4	92	24.7	91	24.6
MET	17.9	2.7	93	16.6	93	16.7	92	16.5
CYS	5.4	0.8	83	4.5	86	4.6	79	4.3
MET+CYS	23.3	3.6	90	21.1	91	21.3	89	20.7
TRP	6.5	1.0	92	6.0	89	5.8		
ILE	27.3	4.2	92	25.1	93	25.4	93	25.4
VAL	32.4	5.0	91	29.5	92	29.8	92	29.8
LEU	46.8	7.2	93	43.3	94	43.7	93	43.5
PHE	25.5	3.9	91	23.3	92	23.5	92	23.5
TYR	19.8	3.0	91	18.1	92	18.3	85	16.9
PHE+TYR	45.3	6.9	91	41.3	92	41.8	89	40.3
HIS	16.0	2.4	88	14.1	89	14.2	89	14.2
ARG	38.8	5.9	94	36.3	94	36.5	93	36.1
ALA	41.2	6.3	91	37.6	92	38.0		
ASP	60.2	9.2	87	52.4	88	52.9	82	49.3
GLU	82.6	12.6	93	76.5	94	77.2	90	74.3
GLY	42.9	6.6	88	37.8	89	38.3		
SER	25.4	3.9	90	22.8	91	23.1	82	20.8
PRO	26.5	4.1	91	24.1	93	24.6		

Fish meal, protein 70%

Product obtained by processing whole or parts of fish, containing 68-75% protein (as fed) (n = 431).

All values are expressed on an as fed basis unless noted otherwise.

Main constituents	mean	sd	Fatty acids	%FA	g/kg
Dry matter (%)	92.0	1.3	Myristic acid C14:0	6.0	4.4
Crude protein (%)	69.9	1.7	Palmitic acid C16:0	17.8	12.9
Ether extract (%)	9.3	1.5	Palmitoleic acid C16:1	7.2	5.2
Ether extract (hydrolysis) (%)	9.7	1.6	Stearic acid C18:0	3.6	2.6
Ash (%)	12.4	2.1	Oleic acid C18:1	12.3	8.9
Insoluble ash (%)	0.3	0.3	Linoleic acid C18:2	2.1	1.5
Gross energy (MJ/kg)	20.0	1.1	Linolenic acid C18:3	1.9	1.4
			Steradonic acid C 18:4	1.5	1.1
			Eicosenoic acid C20:1	6.6	4.8
			Arachidonic acid C20:4	2.4	1.7
			Eicosapentaenoic acid C20:5	9.0	6.5
			Erucic acid C22:1	7.7	5.6
			Clupanodonic acid C22:5	2.6	1.9
			Docosahehexanoic acid C22:6	6.6	4.8
			Fatty acids/ether extract (%)	75	

Mineral elements	mean	sd	Vitamins	mean
Calcium (g/kg)	24.1	7.9	Vitamin E (mg/kg)	20
Phosphorus (g/kg)	20.6	2.6	Vitamin K (mg/kg)	2
Magnesium (g/kg)	1.9		Vitamin B1 - thiamin (mg/kg)	0.30
Potassium (g/kg)	12.2		Vitamin B2 - riboflavin (mg/kg)	9
Sodium (g/kg)	9.5	2.4	Vitamin B6 - pyridoxine (mg/kg)	5
Chlorine (g/kg)	15.1	5.0	Vitamin B12 (µg/kg)	415
Sulphur (mg/kg)	6.7		Niacin (mg/kg)	102
DCAD (mEq/kg)	-120		Pantothenic acid (mg/kg)	15
EB (mEq/kg)	300		Folic acid (mg/kg)	0.41
Manganese (mg/kg)	6		Biotin (mg/kg)	0.42
Zinc (mg/kg)	88		Choline (%)	4690
Copper (mg/kg)	7			
Iron (mg/kg)	252	73		
Selenium (mg/kg)	0.40			
Molybdenum (mg/kg)	0.18			
Iodine (mg/kg)	3			

Pigs	Growing	Sow	Poultry	Cockerel	Broiler
DE (MJ/kg)	17.0	17.0	AMEn (MJ/kg)	14.6	14.6
ME (MJ/kg)	15.4	15.4	P availability (%)		85
NE (MJ/kg)	9.9	9.9	Fish		
Ed (%)	85	85	DE (MJ/kg)	15.7	
OMd (%)	85	85	Ed (%)	78	
Nd (%)	85	85	Nd (%)	89	
EEd (%)		85	Pd (%)	51	
Pd (%)		77			

Amino acid content and digestibility

Amino acids	Total		Pigs				Poultry	
	g/kg	% CP	AID %	AIDC g/kg	SID %	SIDC g/kg	TD %	TDC g/kg
LYS	52.6	7.5					89	46.8
THR	29.1	4.2					91	26.5
MET	19.9	2.8					92	18.3
CYS	5.8	0.8					79	4.6
MET+CYS	25.7	3.7					89	22.9
TRP	7.2	1.0						
ILE	30.1	4.3					93	28.0
VAL	35.4	5.1					92	32.6
LEU	50.3	7.2					93	46.8
PHE	27.4	3.9					92	25.2
TYR	21.2	3.0					85	18.0
PHE+TYR	48.6	7.0					89	43.2
HIS	16.6	2.4					89	14.7
ARG	40.5	5.8					93	37.7
ALA	43.8	6.3						
ASP	64.2	9.2					82	52.7
GLU	90.0	12.9					90	81.0
GLY	39.5	5.7						
SER	27.1	3.9					82	22.2
PRO	28.4	4.1						

Fish solubles, condensed, defatted

Concentrated fish soluble proteins obtained by enzymatic hydrolysis, filtration, concentration and dehydration of whole fish or filleting waste, containing less than 15% fat (as fed) (n = 1).

All values are expressed on an as fed basis unless noted otherwise.

Main constituents	mean	sd	Fatty acids	%FA	g/kg
Dry matter (%)	94.2		Myristic acid C14:0	6.0	2.1
Crude protein (%)	80.0		Palmitic acid C16:0	17.8	6.3
Ether extract (hydrolysis) (%)	4.7		Palmitoleic acid C16:1	7.2	2.6
Ash (%)	7.9		Stearic acid C18:0	3.6	1.3
Gross energy (MJ/kg)	20.8		Oleic acid C18:1	12.3	4.4
			Linoleic acid C18:2	2.1	0.7
			Linolenic acid C18:3	1.9	0.7
			Steradonic acid C 18:4	1.5	0.5
			Eicosenoic acid C20:1	6.6	2.3
			Arachidonic acid C20:4	2.4	0.9
			Eicosapentaenoic acid C20:5	9.0	3.2
			Erucic acid C22:1	7.7	2.7
			Clupanodonic acid C22:5	2.6	0.9
			Docosahexaneic acid C22:6	6.6	2.3
			Fatty acids/ether extract (%)	75	

Mineral elements	mean	sd	Vitamins	mean
Calcium (g/kg)	6.7		Vitamin B1 - thiamin (mg/kg)	7
Phosphorus (g/kg)	15.4		Vitamin B2 - riboflavin (mg/kg)	15
Magnesium (g/kg)	1.6		Vitamin B6 - pyridoxine (mg/kg)	12
Potassium (g/kg)	15.5		Vitamin B12 (µg/kg)	506
Sodium (g/kg)	9.6		Niacin (mg/kg)	213
Chlorine (g/kg)	15.0		Pantothenic acid (mg/kg)	51
Sulphur (mg/kg)	4.1		Folic acid (mg/kg)	0.74
DCAD (mEq/kg)	140		Biotin (mg/kg)	0.25
EB (mEq/kg)	396		Choline (%)	4049
Manganese (mg/kg)	51			
Zinc (mg/kg)	78			
Copper (mg/kg)	36			
Iron (mg/kg)	307			
Selenium (mg/kg)	2			

Pigs	Growing	Sow	Poultry	Cockerel	Broiler
DE (MJ/kg)	17.7	17.7	AMEn (MJ/kg)	15.3	15.3
ME (MJ/kg)	15.8	15.8	P availability (%)		85
NE (MJ/kg)	9.6	9.6	Fish		
Ed (%)	85	85	DE (MJ/kg)		
OMd (%)	85	85	Ed (%)		
Nd (%)	85	85	Nd (%)	95	
NSId (%)		93	Pd (%)		
EEd (%)		85			

Amino acid content and digestibility

Amino acids	Total		Pigs				Poultry	
	g/kg	% CP	AID	AIDC	SID	SIDC	TD	TDC
			%	g/kg	%	g/kg	%	g/kg
LYS	47.5	5.9	95	45.3	96	45.8	91	43.3
THR	29.8	3.7	94	28.0	96	28.6	91	27.2
MET	17.5	2.2	95	16.7	96	16.9	95	16.6
CYS	6.4	0.8	78	5.0	84	5.3	68	4.4
MET+CYS	23.9	3.0	92	22.0	94	22.4	88	21.0
TRP								
ILE	24.2	3.0	95	22.9	97	23.4	91	22.0
VAL	29.6	3.7	94	27.9	96	28.5	92	27.2
LEU	42.6	5.3	96	40.8	98	41.5	93	39.6
PHE	23.8	3.0	97	23.1	99	23.6	92	21.9
TYR	18.3	2.3	94	17.2	98	17.9	90	16.4
PHE+TYR	42.1	5.3	96	40.4	99	41.5	91	38.4
HIS	12.5	1.6	93	11.7	95	11.8	86	10.8
ARG	45.4	5.7	98	44.3	99	44.7	95	43.1
ALA	44.5	5.6	96	42.8	97	43.2	95	42.3
ASP	56.5	7.1	87	49.3	89	50.1	89	50.3
GLU	96.2	12.0	96	92.1	97	93.1	95	91.4
GLY	74.0	9.2	94	69.9	95	70.2		
SER	34.5	4.3	95	32.8	96	33.2	91	31.4
PRO			97		98			

Fish solubles, condensed, fat

Concentrated fish soluble proteins obtained by enzymatic hydrolysis, filtration, concentration and dehydration of whole fish or filleting waste, containing more than 15% fat (as fed) (n = 10). All values are expressed on an as fed basis unless noted otherwise.

Main constituents	mean	sd	Fatty acids	%FA	g/kg
Dry matter (%)	96.0	2.3	Myristic acid C14:0	6.0	9.6
Crude protein (%)	72.5	7.6	Palmitic acid C16:0	17.8	28.3
Ether extract (hydrolysis) (%)	21.2		Palmitoleic acid C16:1	7.2	11.5
Ash (%)	6.6	1.1	Stearic acid C18:0	3.6	5.7
Gross energy (MJ/kg)	24.5		Oleic acid C18:1	12.3	19.6
			Linoleic acid C18:2	2.1	3.3
			Linolenic acid C18:3	1.9	3.0
			Stearadonic acid C 18:4	1.5	2.4
			Eicosenoic acid C20:1	6.6	10.5
			Arachidonic acid C20:4	2.4	3.8
			Eicosapentaenoic acid C20:5	9.0	14.3
			Erucic acid C22:1	7.7	12.3
			Clupanodonic acid C22:5	2.6	4.1
			Docosahexaneic acid C22:6	6.6	10.5
			Fatty acids/ether extract (%)	75	

Mineral elements	mean	sd
Calcium (g/kg)	1.1	
Phosphorus (g/kg)	13.9	
Magnesium (g/kg)	1.6	
Potassium (g/kg)	16.8	
Sodium (g/kg)	9.6	
Chlorine (g/kg)	14.9	
EB (mEq/kg)	428	
Iron (mg/kg)	64	

Blood meal

Product obtained by drying the blood of slaughtered warm-blooded animals (n = 129).

At the time of writing, the sale and use of this product are prohibited in the European Union and in other countries.

All values are expressed on an as fed basis unless noted otherwise.

Main constituents	mean	sd
Dry matter (%)	94.3	4.0
Crude protein (%)	89.7	5.9
Ether extract (%)	0.8	1.0
Ether extract (hydrolysis) (%)	2.0	2.3
Ash (%)	2.8	2.0
Insoluble ash (%)	0.1	0.0
Gross energy (MJ/kg)	22.9	2.3

Mineral elements	mean	sd	Vitamins	mean
Calcium (g/kg)	1.6	2.1	Vitamin E (mg/kg)	1.0
Phosphorus (g/kg)	2.1	1.2	Vitamin B1 - thiamin (mg/kg)	0.58
Magnesium (g/kg)	0.2	0.0	Vitamin B2 - riboflavin (mg/kg)	2
Potassium (g/kg)	3.6	3.2	Vitamin B6 - pyridoxine (mg/kg)	4
Sodium (g/kg)	4.3	2.1	Vitamin B12 (µg/kg)	34
Chlorine (g/kg)	4.5	5.7	Niacin (mg/kg)	26
Sulphur (mg/kg)	7.8	0.4	Pantothenic acid (mg/kg)	2
EB (mEq/kg)	152		Folic acid (mg/kg)	0.20
Manganese (mg/kg)	5		Biotin (mg/kg)	0.18
Zinc (mg/kg)	23	2	Choline (%)	693
Copper (mg/kg)	5	0		
Iron (mg/kg)	2034	475		
Selenium (mg/kg)	0.58	0.08		
Cobalt (mg/kg)	0.10			
Molybdenum (mg/kg)	0.21			
Iodine (mg/kg)	0.34	0.05		

Pigs	Growing	Sow	Poultry	Cockerel	Broiler
NSI _d (%)		82	AMEn (MJ/kg)	13.0	13.0
Pd (%)		80	Fish		
			DE (MJ/kg)	18.0	
			Ed (%)	79	
			Nd (%)	92	

Amino acid content and digestibility

Amino acids	Total		Pigs				Poultry	
	g/kg	% CP	AID	AIDC	SID	SIDC	TD	TDC
			%	g/kg	%	g/kg	%	g/kg
LYS	79.7	8.9	86	68.6	86	68.9	87	69.4
THR	40.4	4.5	84	34.0	85	34.3	88	35.6
MET	9.7	1.1	84	8.2	85	8.3	91	8.9
CYS	9.6	1.1	76	7.3	77	7.4	77	7.4
MET+CYS	19.3	2.2	80	15.5	82	15.8	84	16.2
TRP	11.0	1.2	91	10.0	88	9.7		
ILE	12.0	1.3	84	10.1	86	10.4	78	9.4
VAL	74.7	8.3	83	62.3	84	62.6	88	65.7
LEU	109.6	12.2	84	91.9	84	92.3	90	98.7
PHE	61.1	6.8	85	51.9	86	52.2	91	55.6
TYR	25.6	2.9	85	21.9	86	22.1		
PHE+TYR	86.7	9.7	85	73.9	86	74.4		
HIS	56.2	6.3	82	45.8	82	46.0	87	48.9
ARG	37.6	4.2	85	32.0	86	32.3	87	32.7
ALA	69.5	7.8	84	58.7	85	59.0		
ASP	95.5	10.6	82	77.9	82	78.5		
GLU	84.2	9.4	85	71.5	86	72.2		
GLY	39.6	4.4	84	33.0	85	33.4		
SER	43.1	4.8	84	36.4	85	36.7		
PRO	32.6	3.6	86	28.0	87	28.5		

Feather meal

Product obtained by hydrolysing, drying and grinding poultry feathers (n = 123).

At the time of writing, the sale and use of this product are prohibited in the European Union and in other countries.

All values are expressed on an as fed basis unless noted otherwise.

Main constituents	mean	sd	Fatty acids	%FA	g/kg
Dry matter (%)	92.1	2.4	Myristic acid C14:0	2.0	0.9
Crude protein (%)	79.0	6.2	Palmitic acid C16:0	34.8	15.2
Ether extract (%)	6.8	3.1	Palmitoleic acid C16:1	6.2	2.7
Ether extract (hydrolysis) (%)	8.8	2.2	Stearic acid C18:0	13.8	6.1
Insoluble ash (%)	0.3	0.0	Oleic acid C18:1	39.9	17.5
Gross energy (MJ/kg)	21.8	0.8	Linoleic acid C18:2	3.3	1.5
			Fatty acids/ether extract (%)	50	

Mineral elements	mean	sd	Vitamins	mean
Calcium (g/kg)	12.2	4.8	Vitamin E (mg/kg)	7
Phosphorus (g/kg)	8.0	4.5	Vitamin B1 - thiamin (mg/kg)	0.10
Magnesium (g/kg)	0.8	1.2	Vitamin B2 - riboflavin (mg/kg)	2
Potassium (g/kg)	1.2	0.2	Vitamin B6 - pyridoxine (mg/kg)	3
Sodium (g/kg)	1.2	0.2	Vitamin B12 (µg/kg)	80
Chlorine (g/kg)	1.9	0.5	Niacin (mg/kg)	21
Sulphur (mg/kg)	16.6	0.7	Pantothenic acid (mg/kg)	9
EB (mEq/kg)	28		Folic acid (mg/kg)	0.21
Manganese (mg/kg)	15	6	Biotin (mg/kg)	0.08
Zinc (mg/kg)	130	18	Choline (%)	885
Copper (mg/kg)	9	1.0		
Iron (mg/kg)	575	197		
Selenium (mg/kg)	0.70	0.05		
Molybdenum (mg/kg)	0.90			
Iodine (mg/kg)	0.55	0.07		

Pigs	Growing	Sow	Poultry	Cockerel	Broiler
NSId (%)		77	AMEn (MJ/kg)	11.5	11.5
			Fish		
			DE (MJ/kg)	18.8	
			Ed (%)	86	
			Nd (%)	87	

Amino acid content and digestibility

Amino acids	Total		Pigs				Poultry	
	g/kg	% CP	AID %	AIDC g/kg	SID %	SIDC g/kg	TD %	TDC g/kg
LYS	18.2	2.3	63	11.5	65	11.8	63	11.4
THR	39.5	5.0	77	30.5	78	30.8	72	28.4
MET	5.9	0.7	69	4.1	71	4.2	72	4.2
CYS	37.5	4.7	70	26.2	70	26.3	59	22.1
MET+CYS	43.2	5.5	70	30.1	70	30.3	61	26.2
TRP	5.3	0.7	70	3.7	72	3.8		
ILE	41.5	5.2	86	35.6	86	35.8	84	34.8
VAL	61.5	7.8	82	50.6	83	51.0	80	49.2
LEU	68.1	8.6	82	56.1	83	56.5	81	55.2
PHE	40.6	5.1	85	34.4	86	34.7	83	33.7
TYR	22.1	2.8	75	16.5	76	16.7		
PHE+TYR	63.1	8.0	81	51.4	82	51.9		
HIS	7.3	0.9	69	5.1	71	5.2	68	4.9
ARG	57.1	7.2	83	47.7	84	47.9	82	46.9
ALA	40.1	5.1	78	31.3	79	31.8		
ASP	57.3	7.2	62	35.7	63	36.3		
GLU	92.1	11.7	72	66.1	73	66.8		
GLY	62.7	7.9	81	50.5	81	50.9		
SER	96.2	12.2	81	78.1	82	78.4		
PRO	80.9	10.2	77	62.1	77	62.6		

Meat and bone meal, fat < 7.5%

Product obtained by heating, drying and grinding whole or parts of warm-blooded land animals from which the fat has been partially removed. This product contains less than 7.5% fat (as fed) (n = 114). **At the time of writing, the sale and use of this product are prohibited in the European Union and in other countries.**

All values are expressed on an as fed basis unless noted otherwise.

Main constituents	mean	sd	Fatty acids	%FA	g/kg
Dry matter (%)	95.4	2.2	Lauric acid C12:0	0.2	0.1
Crude protein (%)	55.6	3.9	Myristic acid C14:0	2.7	1.0
Ether extract (%)	3.9	1.2	Palmitic acid C16:0	27.5	10.4
Ether extract (hydrolysis) (%)	5.4	1.1	Palmitoleic acid C16:1	3.7	1.4
Ash (%)	31.7	5.2	Stearic acid C18:0	19.2	7.3
Gross energy (MJ/kg)	15.1		Oleic acid C18:1	40.7	15.4
			Linoleic acid C18:2	3.6	1.4
			Linolenic acid C18:3	0.9	0.3
			Arachidic acid C20:0	1.5	0.6
			Fatty acids/ether extract (%)	70	

Mineral elements	mean	sd	Vitamins	mean
Calcium (g/kg)	107.1	25.3	Vitamin E (mg/kg)	1.3
Phosphorus (g/kg)	51.4	12.3	Vitamin B1 - thiamin (mg/kg)	0.52
Magnesium (g/kg)	2.2		Vitamin B2 - riboflavin (mg/kg)	5
Potassium (g/kg)	4.3		Vitamin B6 - pyridoxine (mg/kg)	5
Sodium (g/kg)	7.1	1.0	Vitamin B12 (µg/kg)	122
Chlorine (g/kg)	6.4	2.4	Niacin (mg/kg)	53
Sulphur (mg/kg)	8.9		Pantothenic acid (mg/kg)	5
EB (mEq/kg)	236		Folic acid (mg/kg)	0.51
Manganese (mg/kg)	25		Biotin (mg/kg)	0.10
Zinc (mg/kg)	109		Choline (%)	2074
Copper (mg/kg)	20			
Iron (mg/kg)	581			
Selenium (mg/kg)	0.43			
Cobalt (mg/kg)	1.2			
Molybdenum (mg/kg)	1.0			
Iodine (mg/kg)	1.2			

Pigs	Growing	Sow	Poultry	Cockerel	Broiler
DE (MJ/kg)	10.9	10.9	AMEn (MJ/kg)	9.6	9.5
ME (MJ/kg)	9.6	9.6			
NE (MJ/kg)	6.2	6.0			
Ed (%)	72	72	Fish		
OMd (%)	74	74	DE (MJ/kg)	13.4	
Nd (%)	80	80	Ed (%)	89	
NSId (%)		81	Nd (%)	88	
EEEd (%)		65			
Pd (%)		75			

Amino acid content and digestibility

Amino acids	Total		Pigs				Poultry	
	g/kg	% CP	AID	AIDC	SID	SIDC	TD	TDC
			%	g/kg	%	g/kg	%	g/kg
LYS	28.3	5.1	83	23.4	84	23.8	81	22.9
THR	18.8	3.4	79	14.9	82	15.3	81	15.2
MET	7.3	1.3	85	6.2	86	6.3	86	6.2
CYS	6.5	1.2	64	4.2	67	4.4	59	3.8
MET+CYS	13.8	2.5	77	10.6	79	10.8	73	10.1
TRP	3.7	0.7	76	2.8	80	3.0		
ILE	16.4	3.0	83	13.5	84	13.8	83	13.6
VAL	25.2	4.5	81	20.5	83	20.9	82	20.7
LEU	34.3	6.2	83	28.5	85	29.0	84	28.8
PHE	19.3	3.5	83	16.1	85	16.4	84	16.2
TYR	12.6	2.3	80	10.0	82	10.3		
PHE+TYR	31.9	5.7	82	26.1	84	26.7		
HIS	11.2	2.0	78	8.7	79	8.8	82	9.2
ARG	37.7	6.8	86	32.3	86	32.6	84	31.6
ALA	42.1	7.6	82	34.6	83	35.1		
ASP	41.7	7.5	75	31.1	76	31.8		
GLU	66.0	11.9	82	54.1	83	54.9		
GLY	68.2	12.3	81	55.0	81	55.5		
SER	22.7	4.1	78	17.7	80	18.1		
PRO	44.1	7.9	82	36.2	84	36.8		

Meat and bone meal, fat > 7.5%

Product obtained by heating, drying and grinding whole or parts of warm-blooded land animals from which the fat has been partially removed. This product contains more than 7.5% fat (as fed) (n = 1230). **At the time of writing, the sale and use of this product are prohibited in the European Union and in other countries.**

All values are expressed on an as fed basis unless noted otherwise.

Main constituents	mean	sd	Fatty acids	%FA	g/kg
Dry matter (%)	96.3	1.5	Lauric acid C12:0	0.2	0.2
Crude protein (%)	51.3	3.0	Myristic acid C14:0	2.7	2.3
Ether extract (%)	10.6	1.5	Palmitic acid C16:0	27.5	22.7
Ether extract (hydrolysis) (%)	11.8	1.8	Palmitoleic acid C16:1	3.7	3.1
Ash (%)	30.5	3.4	Stearic acid C18:0	19.2	15.8
Insoluble ash (%)	0.4		Oleic acid C18:1	40.7	33.5
Gross energy (MJ/kg)	16.6		Linoleic acid C18:2	3.6	3.0
			Linolenic acid C18:3	0.9	0.7
			Arachidic acid C20:0	1.5	1.2
			Fatty acids/ether extract (%)	70	

Mineral elements	mean	sd	Vitamins	mean
Calcium (g/kg)	101.9	15.3	Vitamin E (mg/kg)	1.3
Phosphorus (g/kg)	49.0	6.8	Vitamin B1 - thiamin (mg/kg)	0.52
Magnesium (g/kg)	2.2		Vitamin B2 - riboflavin (mg/kg)	5
Potassium (g/kg)	4.4		Vitamin B6 - pyridoxine (mg/kg)	5
Sodium (g/kg)	7.3	1.3	Vitamin B12 (µg/kg)	123
Chlorine (g/kg)	6.6	2.3	Niacin (mg/kg)	54
Sulphur (mg/kg)	8.9		Pantothenic acid (mg/kg)	5
EB (mEq/kg)	245		Folic acid (mg/kg)	0.52
Manganese (mg/kg)	25		Biotin (mg/kg)	0.11
Zinc (mg/kg)	110		Choline (%)	2093
Copper (mg/kg)	20			
Iron (mg/kg)	586			
Selenium (mg/kg)	0.43			
Cobalt (mg/kg)	1.3			
Molybdenum (mg/kg)	1.0			
Iodine (mg/kg)	1.2			

Pigs	Growing	Sow	Poultry	Cockerel	Broiler
DE (MJ/kg)	11.6	11.6	AMEn (MJ/kg)	11.5	11.2
ME (MJ/kg)	10.4	10.4			
NE (MJ/kg)	7.2	7.0			
Ed (%)	70	70			
OMd (%)	71	71			
Nd (%)	80	80			
NSId (%)		81			
EEd (%)		65			
Pd (%)		75			

Amino acid content and digestibility

Amino acids	Total		Pigs				Poultry	
	g/kg	% CP	AID %	AIDC g/kg	SID %	SIDC g/kg	TD %	TDC g/kg
LYS	25.7	5.0	83	21.2	84	21.5	81	20.8
THR	17.0	3.3	79	13.5	82	13.9	81	13.8
MET	6.5	1.3	85	5.5	86	5.6	86	5.6
CYS	5.5	1.1	64	3.5	67	3.7	59	3.2
MET+CYS	12.0	2.3	77	9.2	79	9.5	74	8.9
TRP	3.1	0.6	76	2.3	80	2.5		
ILE	14.7	2.9	83	12.1	84	12.4	83	12.2
VAL	22.5	4.4	81	18.3	83	18.7	82	18.5
LEU	30.6	6.0	83	25.4	85	25.9	84	25.7
PHE	17.3	3.4	83	14.4	85	14.7	84	14.6
TYR	11.2	2.2	80	9.0	82	9.2		
PHE+TYR	28.5	5.6	82	23.4	84	23.9		
HIS	10.1	2.0	78	7.8	79	7.9	82	8.3
ARG	36.1	7.0	86	30.9	86	31.2	84	30.3
ALA	39.3	7.7	82	32.3	83	32.7		
ASP	37.7	7.3	75	28.1	76	28.7		
GLU	60.2	11.7	82	49.3	83	50.1		
GLY	66.6	13.0	81	53.7	81	54.2		
SER	20.6	4.0	78	16.1	80	16.4		
PRO	41.4	8.1	82	34.1	84	34.6		

Processed feed materials: nutritional values for ruminants

The following tables present the nutritional values for ruminants of processed feed materials and high moisture wheat and maize.

The effects of technological processes were quantified only for the dry matter, the degradability parameters (for nitrogen, dry matter and starch) and the true intestinal digestibility of undegraded proteins. These values, and the PDI and the AADI values derived from them, are therefore different between the processed and the unprocessed feed material.

When applicable, the other data (chemical composition and nutritive value) are simply corrected for the dry matter content of the processed feed materials: on a dry matter basis, these data are identical for the processed and unprocessed feed material.

The technological treatments are the following:

- Expansion: the material is heated by air at 280-300°C for 90-120 seconds on a moving bed, and reaches 130 to 150°C until the internal water vaporises, which can cause the seed to split open. Expansion is sometimes followed by flaking.
- Extrusion: the material is forced through a shaping orifice (a die) during a short time (less than 30 seconds) under high pressure and temperature.
- Flaking: the material passes between rollers, usually under moist heat conditions.
- Pellets: this product results from the agglomeration of feed particles after they have been forced through a die.
- Formaldehyde treatment: this process is used to protect certain nutrients (in particular proteins, amino acids and fatty acids) from the action of microorganisms during the passage through the upper part of the digestive tract of ruminants. While several rumen protection processes exist, formaldehyde treatment, which has been used in France since the 1980's, is the only one represented in the tables.
- Toasting: for seeds and grains, toasting is a dry heat treatment using several methods of heat transfer, including conduction (solid support), convection (hot air) and radiation. For oil seed meals, it is mainly performed by indirect heating using steam in a double-wall heating element.

Cereal grains	Barley, toasted	Maize, expanded	Maize, extruded	Maize, flaked	Maize, high moisture	Maize, pelleted	Maize, toasted	Oats, flaked	Oats, toasted	Wheat, high moisture	Wheat, toasted
Dry matter (%)	94.3	91.8	90.3	88.3	64.8	86.4	93.8	88.8	92.0	71.3	92.2
Crude protein (%)	11.0	8.7	8.5	8.3	6.1	8.1	8.8	9.9	10.2	8.7	11.2
Crude fibre (%)	4.9	2.3	2.2	2.2	1.6	2.2	2.3	12.3	12.7	1.8	2.4
Ether extract (%)	2.0	3.9	3.9	3.8	2.8	3.7	4.0	4.8	5.0	1.2	1.6
Ash (%)	2.4	1.3	1.3	1.3	0.9	1.2	1.3	2.7	2.8	1.3	1.7
NDF (%)	20.3	11.0	10.9	10.6	7.8	10.4	11.3	33.0	34.2	10.2	13.2
ADF (%)	6.0	2.8	2.7	2.7	1.9	2.6	2.8	15.0	15.6	2.6	3.3
ADL (%)	1.0	0.5	0.5	0.5	0.4	0.5	0.5	2.5	2.6	0.8	1.0
Gross energy (MJ/kg)	17.3	17.2	16.9	16.5	12.1	16.2	17.5	17.3	17.9	13.0	16.8
UFL (par kg)	1.02	1.12	1.10	1.08	0.79	1.06	1.15	0.78	0.81	0.84	1.08
UFV (par kg)	1.03	1.13	1.11	1.09	0.80	1.06	1.15	0.71	0.74	0.84	1.09
PDIA (g/kg)	48	61	60	56	16	57	63	21	26	9	55
PDIN (g/kg)	80	72	70	68	41	67	73	65	69	53	86
PDIE (g/kg)	109	100	98	93	45	94	103	66	72	62	120
ME (MJ/kg)	11.7	12.4	12.2	12.0	8.8	11.7	12.7	9.3	9.6	9.3	12.1
Ed (%)	81	86	86	86	86	86	86	65	65	86	86
OMd (%)	83	89	89	89	89	89	89	67	67	88	88
Nd (%)	66	66	66	66	66	66	66	55	55	70	70
Tld (%)	89	90	90	90	90	90	90	92	92	92	94
FAd (%)	66	74	74	74	74	74	74	75	75	63	63
Nitrogen ED (%)	56	30	30	33	74	30	29	79	75	90	53
a nitrogen (%)	24	49	52	13	11	16	16	51	52	84	15
b nitrogen (%)	71	51	48	87	41	75	79	38	37	8	80
c nitrogen (%/h)	5.0	3.5	6.5	31.0	2.5	4.0	1.0	16.0	9.5	14.5	5.5
Starch ED (%)	68	77	77	86	64	60	50	75	62	85	65
a starch (%)	49	49	52	13	39	39	39	25	46	78	78
b starch (%)	51	51	48	87	61	61	61	25	33	16	16
c starch (%/h)	3.5	6.5	7.0	75	2.5	4.0	1.0	8.5	5.4	4.2	8.2
Dry matter ED (%)	72	65	70	75	74	60	50	75	62	85	65
a dry matter (%)	37	49	52	13	39	39	39	25	46	78	78
b dry matter (%)	49	49	52	13	39	39	39	25	46	78	78
c dry matter (%)	13.6	13.6	13.6	13.6	13.6	13.6	13.6	13.6	13.6	13.6	13.6
AADILYS (% PDIE)	6.5	5.5	5.5	5.6	6.4	5.5	5.5	6.9	6.8	7.2	6.1
AADITHR (% PDIE)	4.9	4.8	4.8	4.8	5.0	4.8	4.8	5.1	5.0	5.2	4.8
AADIMET (% PDIE)	1.9	1.9	1.9	1.9	2.0	1.9	1.9	2.0	1.9	2.0	1.8
AADILE (% PDIE)	5.1	4.9	4.9	4.9	5.2	4.9	4.8	5.2	5.2	5.4	5.0
AADIVAL (% PDIE)	5.7	5.5	5.5	5.5	5.7	5.5	5.5	5.8	5.8	5.8	5.4
AADILEU (% PDIE)	8.1	10.5	10.5	10.4	9.5	10.5	10.5	8.2	8.2	8.1	8.0
AADIPHE (% PDIE)	5.2	5.0	5.0	5.0	5.0	5.0	5.0	5.2	5.2	5.1	5.0
AADIHIS (% PDIE)	2.1	2.3	2.3	2.3	2.1	2.3	2.3	2.0	2.0	2.0	2.1
AADIARG (% PDIE)	4.7	4.6	4.6	4.6	4.6	4.6	4.6	4.9	5.0	4.7	4.7

Values expressed on an as fed basis unless noted otherwise

Legume and oil seeds	Cottonseed, full fat, extruded	Faba bean, coloured, extruded	Faba bean, coloured, toasted	Linseed, extruded, toasted	Lupin, white, extruded, toasted	Lupin, blue, extruded, toasted	Pea, extruded, toasted	Pea, toasted	Rapeseed, full fat, extruded	Rapeseed, full fat, formaldehyde treated	Soybean, full fat, extruded	Soybean, full fat, flaked	Soybean, full fat, formaldehyde treated	Soybean, full fat, toasted
Dry matter (%)	94.0	91.5	92.0	90.3	93.6	93.6	91.6	92.0	92.2	92.2	88.1	91.1	88.6	88.6
Crude protein (%)	22.0	26.9	27.0	22.6	36.0	31.8	21.9	22.0	19.1	19.1	34.8	35.9	35.2	35.2
Crude fibre (%)	24.3	8.3	8.4	9.2	12.0	15.4	5.5	5.5	8.2	8.2	5.2	5.4	5.6	5.6
Ether extract (%)	19.8	1.4	1.4	32.7	8.9	5.5	1.1	1.1	42.0	42.0	17.9	18.5	19.2	19.2
Ash (%)	4.1	3.5	3.5	4.3	3.7	3.5	3.2	3.2	4.0	4.0	5.2	5.4	5.2	5.2
NDF (%)	39.8	14.7	14.8	22.1	20.0	23.1	12.8	12.8	17.6	17.6	11.0	11.4	11.7	11.7
ADF (%)	30.8	9.8	9.8	13.4	14.5	18.4	6.3	6.4	12.4	12.4	6.4	6.6	6.9	6.9
ADL (%)	8.8	0.8	0.8	5.6	1.0	1.6	0.3	0.3	5.5	5.5	1.0	1.1	1.2	1.2
Gross energy (MJ/kg)	22.6	17.2	17.2	24.2	19.8	19.0	16.7	26.4	26.4	26.4	26.4	22.6	17.2	17.2
UFLV (par kg)	0.97	1.10	1.11	1.43	1.24	1.17	1.10	1.11	1.68	1.68	1.27	1.31	1.30	1.30
UFLV (par kg)	0.88	1.10	1.11	1.40	1.24	1.16	1.11	1.12	1.68	1.68	1.27	1.31	1.30	1.30
PDIA (g/kg)	104	102	141	113	132	155	61	103	89	111	180	109	206	118
PDIN (g/kg)	160	197	214	171	263	249	152	170	140	148	262	245	273	238
PDIE (g/kg)	129	154	190	136	188	212	116	156	109	129	214	151	237	157
ME (MJ/kg)	11.7	12.3	12.3	16.2	13.9	13.1	12.2	12.3	18.7	18.7	14.2	14.7	14.6	14.6
Ed (%)	66	90	90	83	91	89	90	90	87	87	90	90	90	90
OMD (%)	64	91	91	80	90	89	92	92	83	83	88	88	88	88
Nd (%)	71	79	79	75	80	80	78	78	75	75	79	79	79	79
TlD (%)	85	98	98	90	100	100	100	100	87	87	88	88	88	82
FAD (%)	78	62	62	79	77	75	57	57	79	79	78	78	78	78
Nitrogen ED (%)	50	65	52	50	67	56	75	58	52	40	47	69	40	63
a nitrogen (%)	31	28	20	21	31	23	49	19	16	16	19	19	18	18
b nitrogen (%)	47	71	76	72	67	74	40	77	80	80	77	77	76	76
c nitrogen (%/h)	4.0	6.5	4.5	4.0	7.0	5.0	11.0	6.0	4.0	4.0	4.0	11.0	8.5	8.5
Starch ED (%)	63	63	63	37	37	37	70	28	70	70	70	70	70	70
a starch (%)	63	63	63	37	37	37	70	28	70	70	70	70	70	70
b starch (%/h)	4.0	6.5	4.5	4.0	7.0	5.0	11.0	6.0	4.0	4.0	4.0	11.0	8.5	8.5
c starch (%/h)	4.0	6.5	4.5	4.0	7.0	5.0	11.0	6.0	4.0	4.0	4.0	11.0	8.5	8.5
Dry matter ED (%)	45	70	60	41	67	60	78	60	60	55	58	82	55	65
a dry matter (%)	41	20	33	20	33	33	70	60	29	29	40	40	40	40
b dry matter (%)	53	54	63	54	63	63	23	64	64	64	64	64	64	64
c dry matter (%)	7.1	3.8	7.3	3.1	3.8	7.3	3.1	5.0	5.0	5.0	11.4	11.4	11.4	11.4
AAI LYS (% PDIE)	6.2	7.3	7.3	5.3	6.3	6.3	7.7	7.7	7.2	7.2	6.8	7.0	6.8	6.9
AAI THR (% PDIE)	4.8	4.8	4.7	5.0	4.7	4.8	5.0	4.8	5.3	5.3	4.7	4.8	4.7	4.8
AAI MET (% PDIE)	1.8	1.3	1.2	1.8	1.3	1.3	1.6	1.4	2.1	2.1	1.5	1.6	1.5	1.6
AAI ILE (% PDIE)	4.4	5.0	5.0	5.2	5.2	5.2	5.2	5.1	4.9	4.9	5.1	5.2	5.1	5.1
AAI VAL (% PDIE)	5.1	5.4	5.3	5.5	5.2	5.2	5.6	5.5	5.8	5.8	5.3	5.4	5.2	5.3
AAI LEU (% PDIE)	7.4	8.4	8.5	7.6	8.2	8.2	8.2	8.2	7.9	7.9	8.3	8.2	8.3	8.2
AAI PHE (% PDIE)	5.5	4.7	4.6	5.5	4.4	4.4	5.0	5.0	4.5	4.4	5.1	5.1	5.1	5.1
AAI HIS (% PDIE)	2.9	2.3	2.3	2.2	2.1	2.2	2.2	2.3	2.5	2.5	2.4	2.3	2.4	2.4
AAI ARG (% PDIE)	6.7	6.1	6.3	6.8	6.6	6.4	5.6	5.9	5.3	5.3	5.7	5.5	5.7	5.5

Values expressed on an as fed basis unless noted otherwise

Oil seed meals	Cottonseed meal, toasted	Rapeseed meal, extruded	Rapeseed meal, formaldehyde treated	Rapeseed meal, toasted	Soybean meal 48, extruded	Soybean meal 48, formaldehyde treated	Sunflower meal ¹ , formaldehyde treated	Sunflower meal ¹ , toasted
Dry matter (%)	90.1	88.7	88.7	88.7	87.8	87.8	88.7	88.7
Crude protein (%)	36.3	33.7	33.7	33.7	45.3	45.3	27.7	27.7
Crude fibre (%)	16.9	12.4	12.4	12.4	6.0	6.0	25.5	25.5
Ether extract (%)	2.7	2.3	2.3	2.3	1.9	1.9	2.0	2.0
Ash (%)	6.5	7.0	7.0	7.0	6.4	6.4	6.2	6.2
NDF (%)	31.8	28.3	28.3	28.3	12.2	12.2	41.1	41.1
ADF (%)	22.2	19.6	19.6	19.6	7.3	7.3	29.3	29.3
ADL (%)	6.8	9.5	9.5	9.5	0.7	0.7	10.1	10.1
Gross energy (MJ/kg)	18.3	17.1	17.1	17.1	17.3	17.3	17.2	17.2
UFL (par kg)	0.80	0.85	0.85	0.85	1.06	1.06	0.56	0.56
UFV (par kg)	0.73	0.80	0.80	0.80	1.05	1.05	0.46	0.46
PDIA (g/kg)	185	109	112	140	192	337	184	184
PDIN (g/kg)	275	225	255	239	334	389	231	224
PDIE (g/kg)	219	154	246	182	242	374	224	206
ME (MJ/kg)	9.6	10.0	10.0	10.0	11.9	11.9	7.0	7.0
Ed (%)	69	76	76	76	92	92	53	53
OMd (%)	77	77	77	77	92	92	54	54
Nd (%)	76	78	78	78	80	80	71	71
TlId (%)	90	81	81	85	93	93	89	89
Fad (%)	70	69	69	69	66	66	67	67
Nitrogen ED (%)	49	64	30	56	59	28	26	33
a nitrogen (%)	26	15	9	29	10	0	9	23
b nitrogen (%)	62	85	74	63	86	85	84	39
c nitrogen (%/h)	3.5	8.0	2.5	4.5	8.0	3.0	1.5	2.0
Starch ED (%)								
a starch (%)								
b starch (%)								
c starch (%/h)								
Dry matter ED (%)	27	55	41	51	65	46	35	40
a dry matter (%)	6	20	20	28	19	19		
b dry matter (%)	62	58	63	58	79	79		
c dry matter (%/h)	3.0	3.8	2.9	3.8	3.0	3.0		
AADILYS (% PDIE)	5.7	6.7	6.5	6.7	6.9	6.8	5.1	5.2
AADITHR (% PDIE)	4.5	5.1	5.0	5.0	4.7	4.6	4.6	4.6
AADIMET (% PDIE)	1.6	2.0	2.0	1.4	2.2	2.2	2.2	2.2
AADILE (% PDIE)	4.5	5.1	4.9	5.0	5.1	5.1	4.9	4.9
AADIVAL (% PDIE)	5.3	5.7	5.7	5.7	5.3	5.3	5.5	5.5
AADILEU (% PDIE)	7.4	8.1	8.1	8.1	8.2	8.2	7.7	7.7
AADIPHE (% PDIE)	5.7	4.6	4.5	4.5	5.2	5.2	4.9	4.9
AADIHIS (% PDIE)	2.7	2.4	2.5	2.4	2.4	2.4	2.4	2.4
AADIARG (% PDIE)	7.3	5.2	5.3	5.3	5.6	5.8	6.3	6.3

Values expressed on an as fed basis unless noted otherwise ¹ Sunflower meal from undecorticated seeds

Fats

Fats from land animals

	Lard Rendered pork fat	Tallow Heat-treated fat trimmings from ruminants obtained before the carcass is split.	Poultry fat
Fatty acids (% total FA)			
C12:0	0.1	0.1	0.1
C14:0	1.4	3.3	1.1
C16:0	24.4	25.3	21.0
C16:1	2.9	3.4	5.0
C18:0	14.4	19.2	7.1
C18:1	42.3	37.5	41.7
C18:2 ω -6	9.2	2.8	20.6
C18:3 ω -3	0.9	0.6	1.6
C20:0	0.4		1.0
C20:1	0.9		0.7
C20:4 ω -6	1.7	0.2	0.1
Vitamin			
E (mg/kg)	19	19	27
Gross energy			
GE (MJ/kg)	Values the same for all fats 39.3		
Porcs			
DE growing pig, sow (MJ/kg)	33.4		
ME growing pig, sow (MJ/kg)	33.1		
NE growing pig, sow (MJ/kg)	29.8		
Ed, OMD, EEd (%)	85		
Poultry			
AMEn cockerel (MJ/kg)	36.1	33.4	37.7
AMEn broiler (MJ/kg)	34.5	30.2	36.9
Ruminants			
Values the same for all fats			
UFL (per kg)	2.73		
UFV (per kg)	2.78		
MOd (%)	90		
Ed (%)	88		
Rabbits			
DE (MJ/kg)	33.5		
MEEn (MJ/kg)	33.5		
Ed (%)	85		

Fish oils

	Anchovy	Capelin	Cod liver	Herring	Menhaden	Redfish	Salmon	Sardine
Fatty acids (% FA)								
C14:0	7.2	7.9	3.7	6.2	9.9	4.9	3.7	7.6
C16:0	17.8	10.7	13.0	12.7	20.9	13.2	10.2	16.2
C16:1	9.8	9.9	8.9	7.5	12.5	13.2	8.7	9.2
C18:0	3.9	1.2	2.4	1.1	3.4	2.2	4.7	3.5
C18:1	12.0	16.1	24.3	12.9	13.0	13.3	18.6	11.4
C18:2 ω -6	1.1	1.2	1.3	1.1	1.1	0.9	1.2	1.3
C18:3 ω -3	0.8	0.3	0.5	0.7	0.8	0.5	0.6	0.9
C18:4 ω -3	2.4	1.4	0.9	1.4		1.1	2.1	2
C20:1	1.9	19.8	11.3	15.1	1.9	17.2	8.4	3.2
C20:4 ω -6	0.3	0.1	1.1	0.3	0.6	0.3	0.9	1.6
C20:5 ω -3	18.3	3.7	11.0	6.8	12.2	8.0	12.0	16.9
C22:1	1.4	17.1	4.6	22.0	0.7	18.9	5.5	3.8
C22:5 ω -3	1.5	0.3	1.4	0.8	1.7	0.6	2.9	2.5
C22:6 ω -3	8.5	2.0	10.8	5.8	7.9	8.9	13.8	21.9
Σ ω -3	31.5	7.7	24.6	15.5	22.6	19.1	31.4	44.2
Σ ω -6	1.4	1.3	2.4	1.4	1.7	1.2	2.1	2.9

Vitamins

A (1000 UI/kg)	833
D (1000 UI/kg)	92

Gross energy

Values the same for all oils

GE (MJ/kg)	39.3
------------	------

Pigs

DE growing pig, sow (MJ/kg)	33.4
ME growing pig, sow (MJ/kg)	33.1
NE growing pig, sow (MJ/kg)	29.8
Ed, OMd, EEd (%)	85

Poultry

AMEn cockerel (MJ/kg)	38.5
AMEn broiler (MJ/kg)	38.1

Ruminants

UFL (per kg)	2.73
UFV (per kg)	2.78
MOd (%)	90
Ed (%)	88

Fish

DE (MJ/kg)	37.8
Ed (%)	96

Vegetable oils

	Copra	Palm	Rapeseed	Soybean	Sunflower
Fatty acids (% FA)					
C6+C8+C10	13.1				
C12:0	46.4	0.3	0.2		0.2
C14:0	17.7	0.6	0.1	0.1	0.2
C16:0	8.9	43.0	4.2	10.5	6.3
C16:1	0.4	0.2	0.4	0.2	0.4
C18:0	3.0	4.4	1.8	3.8	4.3
C18:1	6.5	37.1	58.0	21.7	20.3
C18:2 ω -6	1.8	9.9	20.5	53.1	64.9
C18:3 ω -3	0.1	0.3	9.8	7.4	0.3
C20:0	0.5	0.4		0.3	
C20:1				0.2	
C22:1			0.4	0.3	
Vitamins					
A (1000 UI/kg)		145	18	19	0.3
D (1000 UI/kg)				0	0
E (mg/kg)	21	95	219	170	625
K (mg/kg)	0	0	2	0	0
Gross energy Values the same for all oils					
GE (MJ/kg)			39.3		
Pigs					
DE growing pig, sow (MJ/kg)			33.4		
ME growing pig, sow (MJ/kg)			33.1		
NE growing pig, sow (MJ/kg)			29.8		
Ed, Omd, EEd (%)			85		
Poultry					
AMEn cockerel (MJ/kg)	37.7	33.4	38.1	38.1	38.1
AMEn broiler (MJ/kg)	35.0	29.5	37.7	37.7	37.7
Ruminants Values the same for all oils					
UFL (per kg)			2.73		
UFV (per kg)			2.78		
OMd (%)			90		
EEd (%)			88		
Rabbits					
DE (MJ/kg)			35.2	35.6	35.6
MEn (MJ/kg)			35.2	35.6	35.6
Ed (%)			90	91	91
Horses Values the same for all oils					
UFC (per kg)			2.96		
OMd and Ed (%)			88		

Synthetic amino acids

Characteristics	L-lysine HCl	L-threonine	L-tryptophan	DL-methionine	Methionine Hydroxy-Analogue, liquid
As fed basis					
DM (%)	99.5	99.5	99.5	99.5	88.0
CP (%) ¹	95.4	73.1	85.3	58.4	0 ²
LYS (%)	79.8				
THR (%)		99.0			
TRP (%)			98.5		
MET (%)				99.0	3
GE (MJ/kg)	20.0 ⁴	17.2	27.5	23.6	20.9 ⁵
Pigs					
DE growing pig, sow (MJ/kg)	20.0	17.2	27.5	23.6	20.9
ME growing pig, sow (MJ/kg)	18.2	15.8	25.8	22.4	19.8
NE growing pig, sow (MJ/kg)	14.1	12.3	20.0	17.3	15.3
Poultry					
AMEn cockerel, broiler (MJ/kg)	14.0	12.6	21.7	19.4	16.7
Rabbits					
DE (MJ/kg)	20.0	17.2	27.5	23.6	20.9

It is assumed that industrial amino acids obtained by chemical synthesis or fermentation are totally digestible in monogastric species. This corresponds to a value of 100% for standardised digestibility (SID) in the pig and true digestibility (TD) in poultry. However, this is not the case for the methionine hydroxy-analogue (see note 3).

¹ Values calculated by multiplying the nitrogen content by 6.25. Although these products do not contain protein, this figure is useful when recalculating the final protein content of a diet containing both conventional protein sources and free amino acids;

² This product does not contain nitrogen and therefore no protein, as the amino group of methionine is replaced by a hydroxyl group;

³ Strictly speaking, methionine analogues do not contain methionine and need to be converted to this amino acid. This conversion, when complete, gives theoretically 87 g of methionine for 100 g of fresh product (88% dry matter). It should be noted that 20 to 25% of this product is in the form of oligomers and not monomers, thus affecting the nutritional equivalence with methionine. When measured experimentally, the efficiency of this product compared to methionine varies greatly (from 60 to 100%) depending on the protocol, the criteria used and the mathematical models used. In conclusion, the content in methionine equivalent can vary between 52 to 87 g for 100 g of fresh product (88% dry matter);

⁴ Value calculated from pure lysine;

⁵ Value calculated from pure methionine.

Relative biological values of mineral sources

The following tables present for 12 mineral and trace elements the relative biological values (RBV) of the principal mineral sources (data compiled by EMFEMA). For each mineral, the first source indicated is the one used as a reference, except in the case of phosphorus where the references are different for ruminants and monogastrics.

The level of the primary or secondary mineral element in each source is also indicated (calculated data, INRA data or literature data; values expressed on an as fed basis).

The following abbreviations and terms are used:

- Mean: average of the results; sd: standard deviation; n: number of results
- nd: not determined
- variable: product with a highly variable mineral composition

Source	Ca %	RBV Pigs			RBV Poultry			RBV Ruminants		
		Mean	sd	n	Mean	sd	n	Mean	sd	n
Calcium carbonate and ground limestone	35-40	100		5	100		9	100		6
Calcium chloride	36 ^a 27 ^b	105	21	2	nd			125		1
Calcium sulphate	29 ^a 23 ^b	104	4	4	93	9	2	nd		
Dicalcium phosphate	28 ^a 23-26 ^b	nd			108		1	119	8	3
Dolomite limestone	22	94		1	65		1	81	14	3
Limestone	35-38	100	1	3	96	6	3	91		1
Limestone ^c	35-38				100 ^c	0 ^c	2 ^c			
Monocalcium phosphate	18-21	nd			nd			130		1
Oyster shells	34-36	100	2	2	101	1	3	nd		
Oyster shells, ground	34-36	nd			119 ^c 102 ^d		1 ^c 2 ^d	nd		
Tricalcium phosphate	37	nd			108		1	nd		

^a Anhydrous form; ^b Dihydrate form; ^c Laying hens; ^d Broilers

Source	Co %	RBV Pigs			RBV Poultry			RBV Ruminants		
		Mean	sd	n	Mean	sd	n	Mean	sd	n
Cobalt sulphate heptahydrate	22	nd			nd			100		3
Cobalt carbonate ^a	49	nd			nd			106	0	2
Cobalt glucoheptonate	2.5	nd			nd			92	9	2
Cobalt oxide ^a	65-75	nd			nd			67	2	2

^a Feed Grade

Copper										
Source	Cu %	RBV Pigs			RBV Poultry			RBV Ruminants		
		Mean	sd	n	Mean	sd	n	Mean	sd	n
Copper sulphate pentahydrate	25	100		13	100		8	100		16
Copper acetate	32.1	nd			103	10	2	104	7	2
Copper carbonate	54.6	100	8	3	64	4	3	93	8	2
Copper chloride	37	nd			81		1	102	10	4
Copper chloride, tribasic	60	97		1	103		1	nd		
Copper citrate	41	99		1	nd			101		1
Copper lysine	variable	94	16	3	100	6	4	104	23	6
Copper methionine	variable	100		1	91		1	nd		
Copper oxide	80	74	21	4	24	39	4	76	12	3
Copper proteinate	variable	nd			nd			103	3	5

Iodine										
Source	I %	RBV Pigs			RBV Poultry			RBV Ruminants		
		Mean	sd	n	Mean	sd	n	Mean	sd	n
<i>Potassium or sodium iodide</i>	76 ^a 84 ^b	100		1	100		1	100		7
Calcium iodate	65 ^c 51 ^d	nd			95		1	106	1	2
Calcium iodide	86.4	nd			nd			110		1
Diiodosalicylic acid	65	nd			nd			36	10	2
Ethylidiaminedihydroiodide	80	99		1	nd			111	10	3
Pentacalcium orthoperiodate	38	nd			nd			111	15	2

^a Potassium iodide; ^b Sodium iodide; ^c Anhydrous form; ^d Hexahydrate form

Iron										
Source	Fe %	RBV Pigs			RBV Poultry			RBV Ruminants		
		Mean	sd	n	Mean	sd	n	Mean	sd	n
<i>Ferrous sulphate heptahydrate</i>	20	100		8	100		11	nd		
Ferric ammonium citrate	17	nd			115		1	nd		
Ferrous carbonate	47	82	14	3	27	39	5	nd		
Ferric citrate	variable	114		1	nd			nd		
Ferric and ferrous chloride	20 ^a 28 ^b	nd			106		1	nd		
Ferric orthophosphate	37	nd			10	4	4	nd		
Ferric polyphosphate	variable	91		1	nd			nd		
Ferric pyrophosphate	30	81		1	nd			nd		
Ferric sodium pyrophosphate	16	nd			12	8	4	nd		
Ferrous sulphate monohydrate	33	100	2	2	103	1	2	nd		

^a Ferric chloride hexahydrate; ^b Ferrous chloride tetrahydrate

Source	Mg %	RBV Pigs			RBV Poultry			RBV Ruminants		
		Mean	sd	n	Mean	sd	n	Mean	sd	n
Magnesium oxide RG^a	55-59	<i>nd</i>			<i>nd</i>			100		10
Ca, Mg, Na phosphate	5	<i>nd</i>			<i>nd</i>			97	9	2
Dolomite limestone	10	<i>nd</i>			<i>nd</i>			43	22	3
Magnesium acetate	10.7	<i>nd</i>			<i>nd</i>			98		1
Magnesium carbonate RG ^a	31	<i>nd</i>			<i>nd</i>			101	4	2
Magnesium citrate	10.3	<i>nd</i>			<i>nd</i>			95	4	2
Magnesium hydroxide	38-39	<i>nd</i>			<i>nd</i>			99		1
Magnesium lactate	9	<i>nd</i>			<i>nd</i>			91		1
Mg, Ca phosphate	9	<i>nd</i>			<i>nd</i>			91		1
Magnesium oxide ^b	55-59	<i>nd</i>			<i>nd</i>			61	8	5
Magnesium oxide ^c	55-59	<i>nd</i>			<i>nd</i>			84	5	5
Magnesium phosphate	24-28	<i>nd</i>			<i>nd</i>			86	11	5
Magnesium sulphate RG ^a	17 ^d 10 ^e	<i>nd</i>			<i>nd</i>			96	2	3

^a RG : Reagent Grade; ^b Granular form, 25 % of particles > 500µ; ^c Powder form; ^d Monohydrate form;

^e Heptahydrate form

Source	Mn %	RBV Pigs			RBV Poultry			RBV Ruminants		
		Mean	sd	n	Mean	sd	n	Mean	sd	n
Manganese sulphate monohydrate	32	100		1	100		8	100		2
Manganese carbonate	47	95		1	66		1	69	9	2
Manganese chloride	34 ^a 27 ^b	<i>nd</i>			97		1	<i>nd</i>		
Manganese methionine	variable	<i>nd</i>			101		1	113		1
Manganese oxide MnO	77	96		1	85	12	6	91		1
Manganese oxide MnO ₂	43	<i>nd</i>			31		1	67		1
Manganese oxide MnO-Mn ₂ O ₃	64	<i>nd</i>			68		1	<i>nd</i>		
Manganese proteinate	variable	<i>nd</i>			109	12	2	<i>nd</i>		

^a Dihydrate form; ^b Tetrahydrate form

Source	Mo %	RBV Pigs			RBV Poultry			RBV Ruminants		
		Mean	sd	n	Mean	sd	n	Mean	sd	n
Monosodium molybdate hydrated	39.6	<i>nd</i>			<i>nd</i>			100		1
Ammonium molybdate	54.5	<i>nd</i>			<i>nd</i>			114		1
Molybdenum metal	98	<i>nd</i>			<i>nd</i>			60		1
Molybdenum trioxide	66.3	<i>nd</i>			<i>nd</i>			121		1

Phosphorus		RBV Pigs			RBV Poultry			RBV Ruminants		
Source	P %	Mean	sd	n	Mean	sd	n	Mean	sd	n
Monosodium phosphate	20^a	100		4	100		3	99		1
(reference for monogastrics)	25.5^b									
Ca, Al, Fe phosphate	12	nd			12		1	nd		
Diammonium phosphate	23	nd			nd			97	14	3
Monoammonium phosphate	27	nd			nd			99	5	2
Dicalcium phosphate		nd			nd			100		8
(reference for ruminants)										
Ca, Mg, Na phosphate	17	93		1	90		1	103	1	2
Dicalcium phosphate anhydrous	20-22	73 ^c	10	7	76	10	6	nd		
Disodium phosphate FG ^g	9 ^a	nd			88		1	nd		
	21.8 ^b									
Magnesium phosphate	13-15	nd			nd			101	4	3
Monocalcium phosphate	22-24	92 ^d	7	16	91	5	4	95	8	3
Monodicalcium phosphate	20	83 ^e	5	3	80	4	4	97	8	2
Monosodium phosphate FG ^f	20 ^a	98	0	2	84		1	99		1
	25.5 ^b									
Phosphate dicalcium hydrated	17.5	77 ^e	8	8	85	1	11	nd		

^a Hydrated form; ^b Anhydrous form; ^c High variations (66-79) according to the industrial origin of the phosphates; ^d High variations (87-97) according to the industrial origin of the phosphates; ^e High variations (80-85) according to the industrial origin of the phosphates; ^f FG : Feed Grade; ^g High variations (75-86) according to the industrial origin of the phosphates

Selenium		RBV Pigs			RBV Poultry			RBV Ruminants		
Source	Se %	Mean	sd	n	Mean	sd	n	Mean	sd	n
Sodium selenite	45	100		7	100		10	100		10
Calcium selenite	41.4	nd			104		1	102		1
Cobalt selenite	32	nd			nd			101		1
Selenium methionine	variable	102	2	2	78	27	8	124		1
Sodium selenate	41	nd			92	25	2	107	12	4
Yeast selenium	variable	108	18	4	nd			109	12	7

Sodium		RBV Pigs			RBV Poultry			RBV Ruminants		
Source	Na %	Mean	sd	n	Mean	sd	n	Mean	sd	n
Sodium chloride	35-39	100		1	100		4	nd		
Disodium phosphate	13 ^a	nd			95		1	nd		
	32 ^b									
Monosodium phosphate	16 ^a	nd			93		1	nd		
	19 ^b									
Sodium bicarbonate	27	96		1	103		1	nd		
Sodium sulphate	32	90		1	103		1	nd		

^a Hydrated form; ^b Anhydrous form

Zinc Source	Zn %	RBV Pigs			RBV Poultry			RBV Ruminants		
		Mean	sd	n	Mean	sd	n	Mean	sd	n
Zinc sulphate heptahydrate RG ^a	22	100		6	100		5	100		10
Zinc carbonate FG ^a	50	nd			nd			58		1
Zinc carbonate RG ^b	52	98		1	93	16	3	105		1
Zinc chloride	48	nd			107		1	42		1
Zinc lysine	variable	89	18	3	nd			107	10	2
Zinc metal	98	105		1	85	25	2	95		1
Zinc methionine	variable	95	8	3	131	11	2	100	3	5
Zinc oxide	80	92	15	3	67	25	8	98	3	5

^a FG : Feed Grade; ^b RG : Reagent Grade

Index

Alfalfa protein concentrate	212	Feather meal	284
Alfalfa, dehydrated, protein < 16% dry matter	252	Fish meal, protein 62%	272
Alfalfa, dehydrated, protein 17-18% dry matter	254	Fish meal, protein 65%	274
Alfalfa, dehydrated, protein 18-19% dry matter	256	Fish meal, protein 70%	276
Alfalfa, dehydrated, protein 22-25% dry matter	258	Fish oil, anchovy	295
Barley	78	Fish oil, capelin	295
Barley, toasted	291	Fish oil, cod liver	295
Barley rootlets, dried	134	Fish oil, herring	295
Beet pulp, dried	214	Fish oil, menhaden	295
Beet pulp, dried, molasses added	216	Fish oil, redfish (sebastes)	295
Beet pulp, pressed	218	Fish oil, salmon	295
Blood meal	282	Fish oil, sardine	295
Brewers' dried grains	136	Fish solubles, condensed, defatted	278
Brewers' yeast, dried	220	Fish solubles, condensed, fat	280
Buckwheat hulls	222	Grape marc, dried	230
Calcium sources	298	Grape seeds	232
Carob pod meal	224	Grapeseed oil meal, solvent extracted	176
Cassava, starch 67%	202	Grass, dehydrated	260
Cassava, starch 72%	204	Groundnut meal, detoxified, crude fibre < 9%	178
Chickpea	144	Groundnut meal, detoxified, crude fibre > 9%	180
Citrus pulp, dried	226	Hominy feed	132
Cobalt sources	298	Iron sources	299
Cocoa hulls	228	Iodine source	299
Cocoa meal, extracted	168	L-Lysine HCL	297
Copper sources	299	L-Threonine	297
Copra meal, expeller	170	L-Tryptophan	297
Copra oil	296	Lard	294
Corn distillers	118	Linseed, full fat	152
Corn gluten feed	120	Linseed, full fat, extruded	292
Corn gluten meal	122	Linseed meal, expeller	182
Cottonseed, full fat	146	Linseed meal, solvent extracted	184
Cottonseed, full fat, extruded	292	Liquid potato feed	234
Cottonseed meal, crude fibre 7-14%	172	Lupin, blue	154
Cottonseed meal, crude fibre 14-20%	174	Lupin, blue, toasted	292
Cottonseed meal, toasted	293	Lupin, white	156
DL-Methionine	297	Lupin, white, extruded	292
Faba bean, coloured flowers	148	Magnesium sources	300
Faba bean, coloured flowers, extruded	292	Maize	80
Faba bean, coloured flowers, toasted	292	Maize bran	124
Faba bean, white flowers	150	Maize, expanded	291
		Maize, extruded	291
		Maize, flaked	291

Maize, high moisture	291	Sodium sources	301
Maize, pelleted	291	Sorghum	90
Maize, toasted	291	Soybean, full fat, extruded	162, 292
Maize feed flour	126	Soybean, full fat, flaked	292
Maize germ meal, expeller	128	Soybean, full fat, formaldehyde-treated	292
Maize germ meal, solvent extracted	130	Soybean, full fat, toasted	164, 292
Maize starch	206	Soybean hulls	244
Manganese sources	300	Soybean meal, 46	192
Meat and bone meal, fat < 7.5%	286	Soybean meal, 48	194
Meat and bone meal, fat > 7.5%	288	Soybean meal, 48, formaldehyde-treated	293
Methionine Hydroxy Analog MHA	297	Soybean meal, 50	196
Milk powder, skimmed	264	Soybean oil	296
Milk powder, whole	266	Sunflower meal, partially decorticated	198
Molasses, beet	236	Sunflower meal, undecorticated	200
Molasses, sugarcane	238	Sunflower meal, undecorticated, formaldehyde-treated	293
Molybdenum sources	300	Sunflower meal, undecorticated, toasted	293
Oats	82	Sunflower oil	296
Oat groats	84	Sunflower seed, full fat	166
Oats, flaked	291	Sweet potato, dried	210
Oats, toasted	291	Tallow	294
Palm kernel meal, expeller	186	Triticale	92
Palm oil	296	Vinasse, different origins	246
Pea	158	Vinasse, from the production of glutamic acid	248
Pea, extruded	292	Vinasse, from yeast production	250
Pea, toasted	292	Wheat bran	98
Phosphorus sources	301	Wheat bran, durum	106
Potato protein concentrate	240	Wheat distillers' grains, starch < 7%	110
Potato pulp, dried	242	Wheat distillers' grains, starch > 7%	102
Potato tuber, dried	208	Wheat, durum	94
Poultry fat	294	Wheat feed flour	104
Rapeseed, full fat	160	Wheat gluten feed, starch 25%	114
Rapeseed, full fat, extruded	292	Wheat gluten feed, starch 28%	116
Rapeseed, full fat, formaldehyde-treated	292	Wheat, high moisture	291
Rapeseed meal	188	Wheat middlings	100
Rapeseed meal, extruded	293	Wheat middlings, durum	108
Rapeseed meal, formaldehyde-treated	293	Wheat shorts	102
Rapeseed meal, toasted	293	Wheat soft	96
Rapeseed oil	296	Wheat straw	262
Rice bran, extracted	138	Wheat, toasted	291
Rice bran, full fat	140	Whey powder, acid	268
Rice, broken	142	Whey powder, sweet	270
Rice, brown	86	Zinc sources	302
Rye	88		
Selenium sources	301		
Sesame meal, expeller	190		